

Projekt nosive armiranobetonske konstrukcije obiteljske kuće

Tutić, Mihael

Undergraduate thesis / Završni rad

2017

Degree Grantor / Ustanova koja je dodijelila akademski / stručni stupanj:

University of Split, Faculty of Civil Engineering, Architecture and Geodesy / Sveučilište u Splitu, Fakultet građevinarstva, arhitekture i geodezije

Permanent link / Trajna poveznica: <https://um.nsk.hr/um:nbn:hr:123:439199>

Rights / Prava: [In copyright](#) / [Zaštićeno autorskim pravom.](#)

Download date / Datum preuzimanja: **2024-11-08**



Repository / Repozitorij:

[FCEAG Repository - Repository of the Faculty of Civil Engineering, Architecture and Geodesy, University of Split](#)



UNIVERSITY OF SPLIT



DIGITALNI AKADEMSKI ARHIVI I REPOZITORIJI



**SVEUČILIŠTE U SPLITU, FAKULTET GRAĐEVINARSTVA, ARHITEKTURE I
GEODEZIJE**

STUDIJ: STRUČNI STUDIJ GRAĐEVINARSTVA

**PROJEKT NOSIVE
ARMIRANOBETONSKE KONSTRUKCIJE
OBITELJSKE KUĆE**

ZAVRŠNI RAD

MENTOR:

dr.sc. Nikola Grgić

STUDENT:

Mihael Tutić

SPLIT, 2017.

SVEUČILIŠTE U SPLITU

FAKULTET GRAĐEVINARSTVA, ARHITEKTURE I GEODEZIJE

Split, Matice hrvatske 15

STUDIJ: **STRUČNI STUDIJ GRAĐEVINARSTVA**

KANDIDAT: Mihael Tutić

BROJ INDEKSA: 1659

KATEDRA: **Katedra za betonske konstrukcije i mostove**

PREDMET: Betonske konstrukcije 2

ZADATAK ZA ZAVRŠNI RAD

Tema: Projekt nosive armiranobetonske konstrukcije obiteljske kuće

Opis zadatka:

Zadana je shema nosive konstrukcije armiranobetonske obiteljske kuće, sa svim potrebnim dimenzijama (prilog zadatku). Također su zadana djelovanja na konstrukciju. Potrebno je proračunati nosivu konstrukciju, te za neke elemente nacrtati planove armature. Statički proračun i armaturne planove izraditi sukladno propisima i pravilima struke.

U Splitu, 19.07.2017.

Voditelji Završnog rada:

dr.sc. Nikola Grgić

TLOCRT PRIZEMLJA

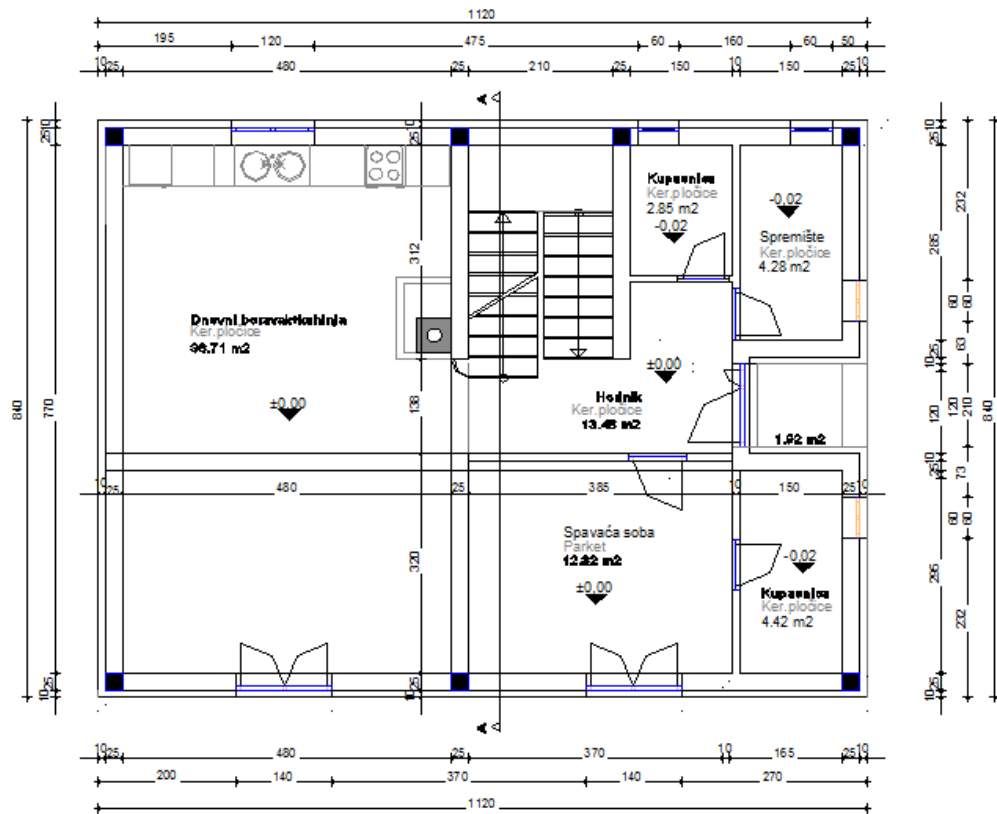

TLOCRT KATA

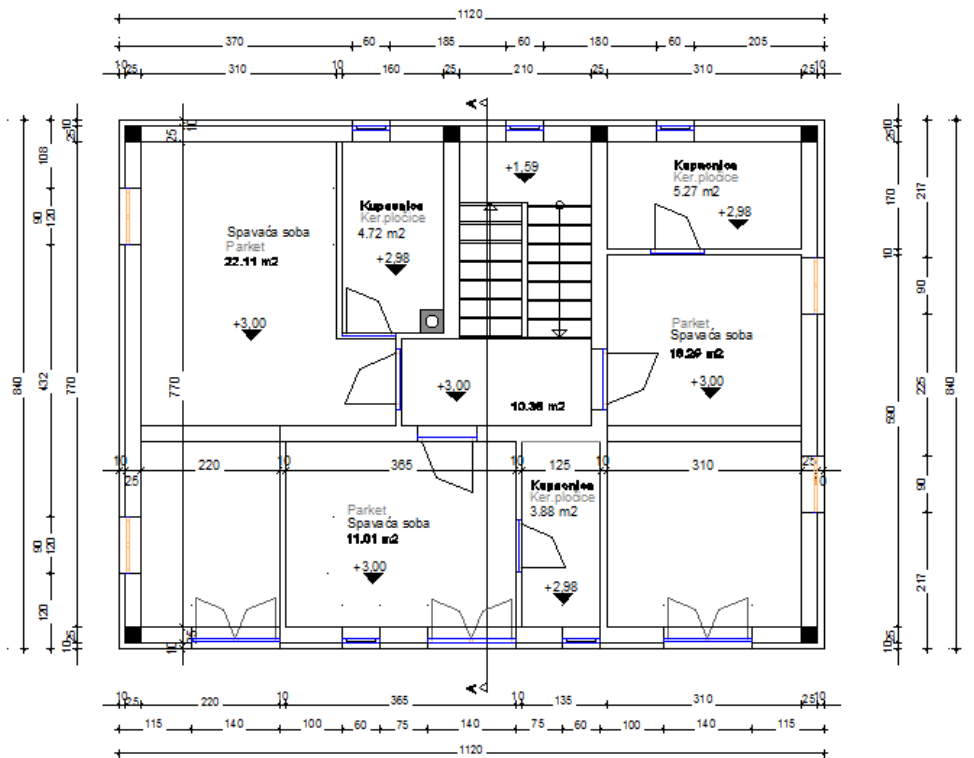

PRESJEK A-A

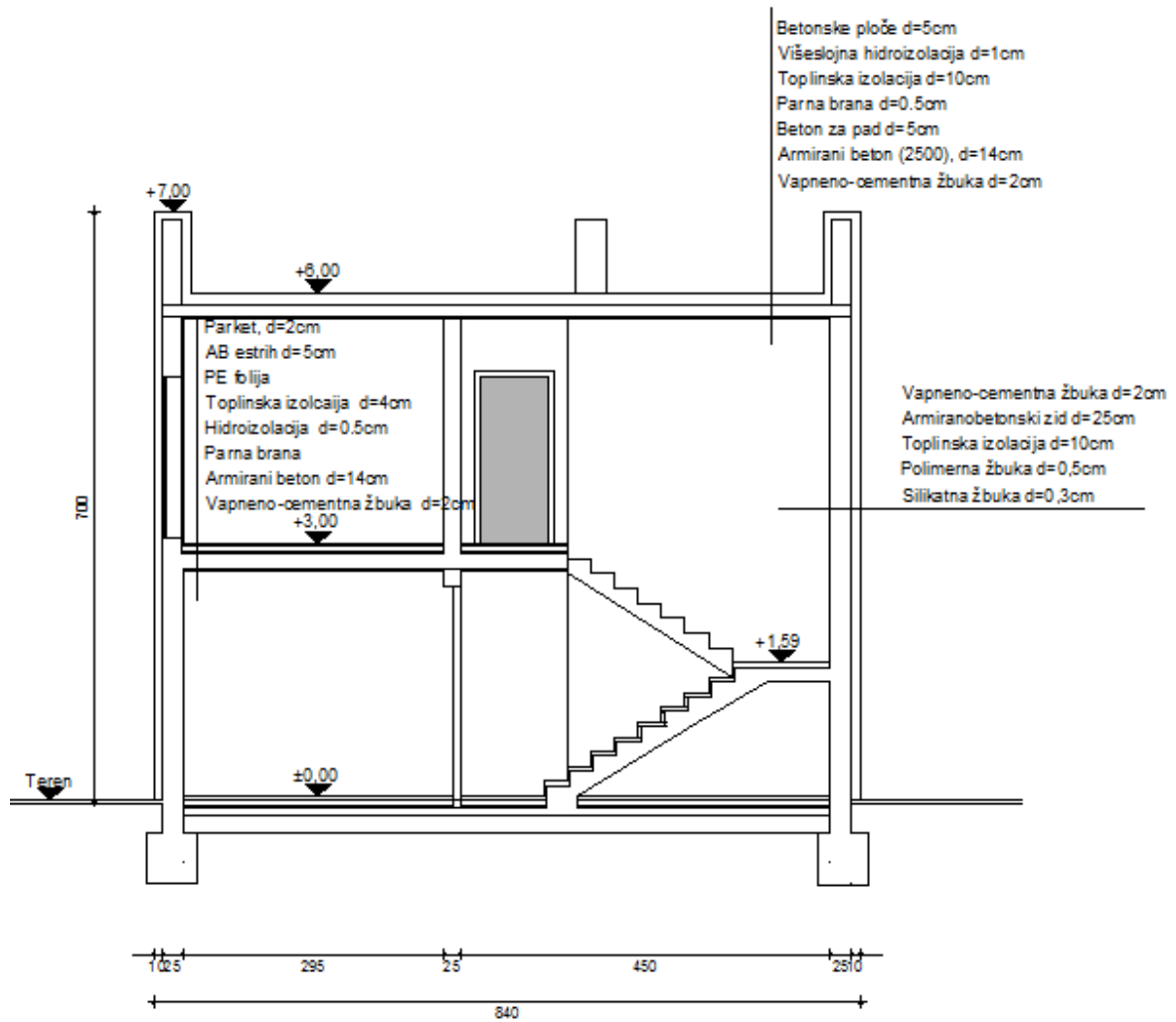

PRILOG:

Na priloženim skicama dana je shema nosive armiranobetonske konstrukcije objekta. U tablici su zadane sve potrebne dimenzije i djelovanja na konstrukciju.

Oznaka	Veličina	Jedinica	Opis
H	3,0	(m)	visina etaža
q	3,5	(kN/m ²)	uporabno opterećenje
Z _v	III		zona vjetra
a _g	0,50	(m/s ²)	proračunsko ubrzanje tla
S	B 500 B		armatura
C	C 30/37		klasa betona

(I) Presjek

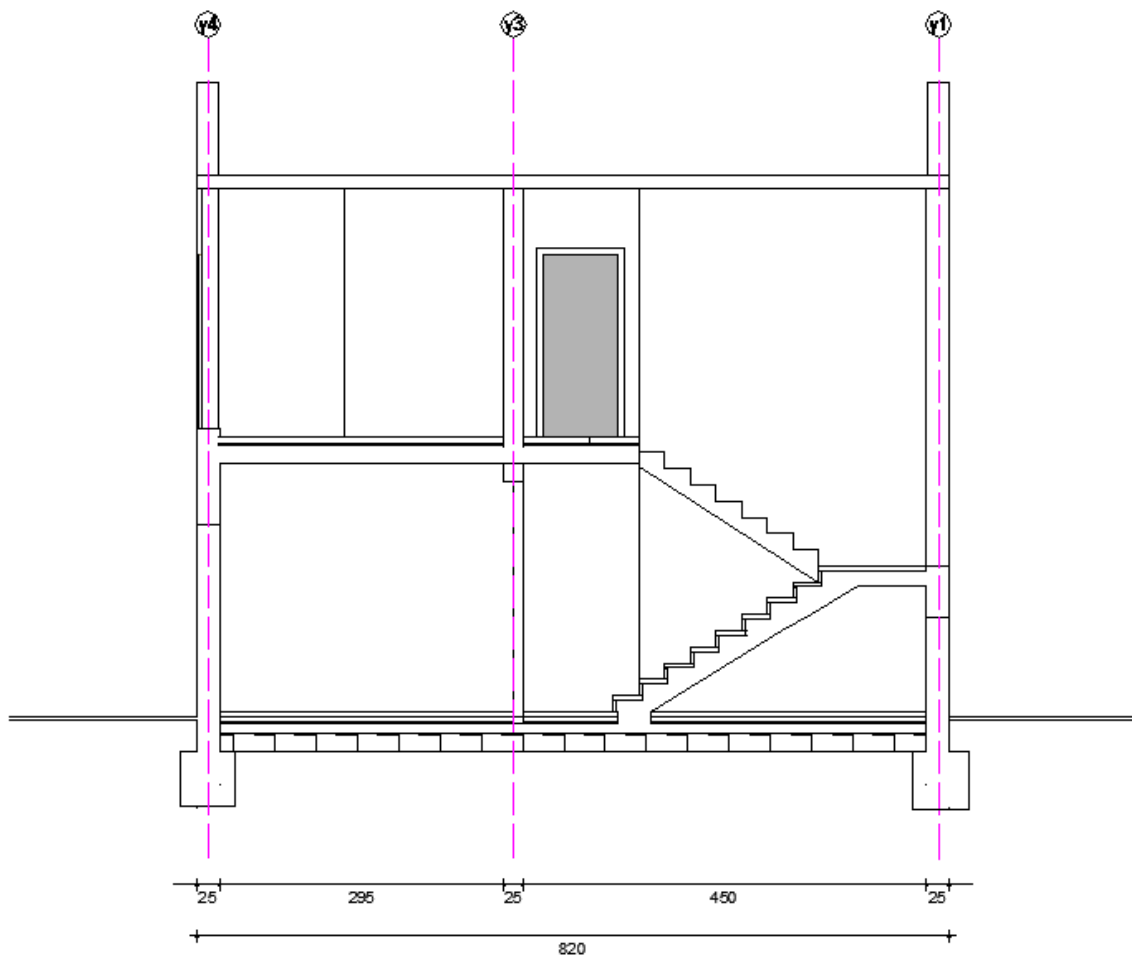

(II) Međuetaza

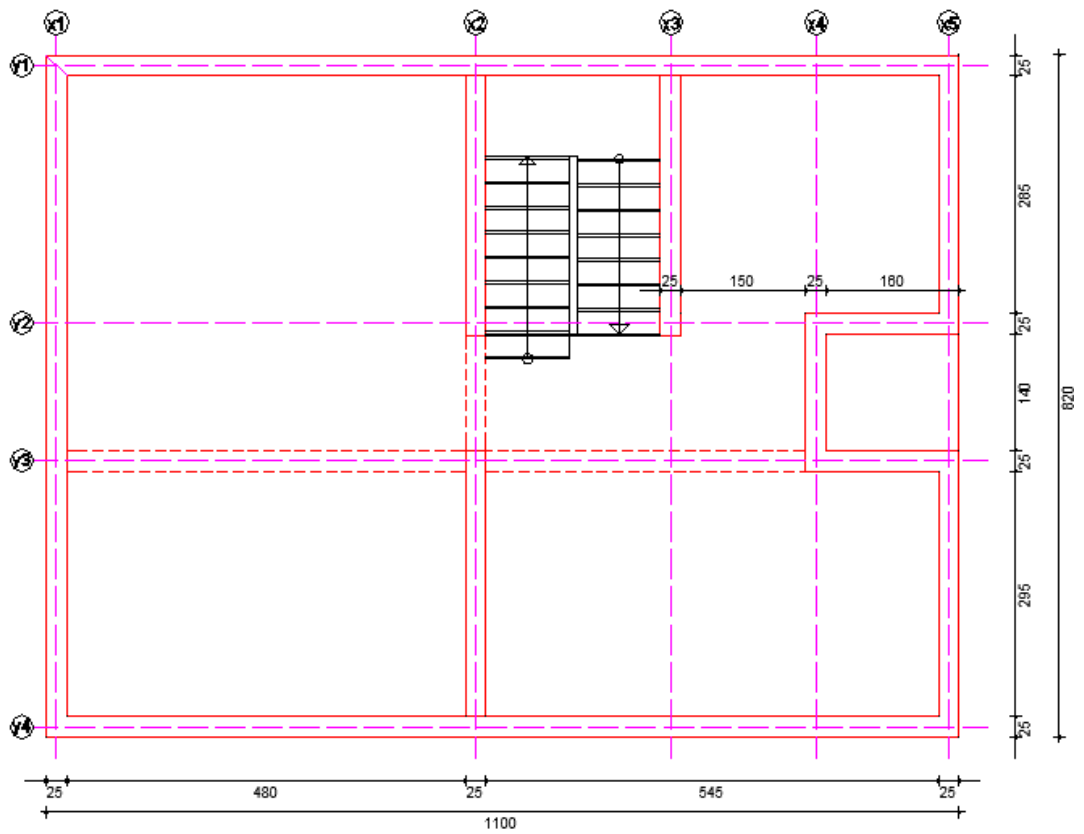

(III) Krovna konstrukcija

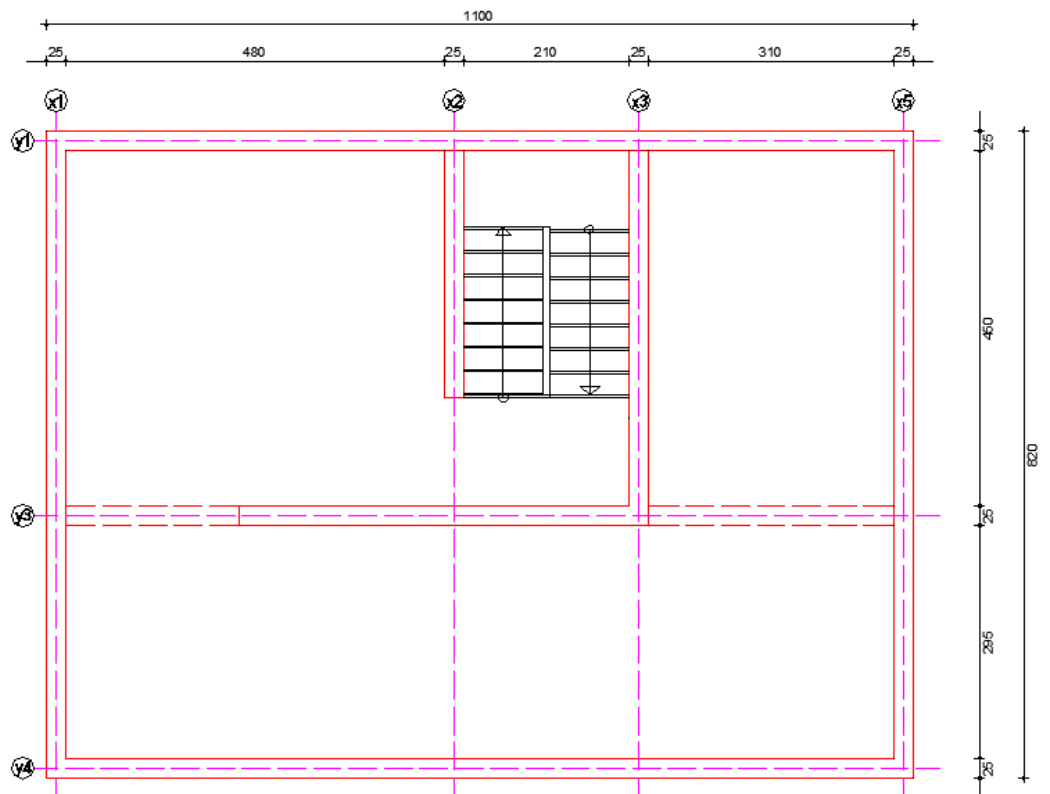

SAŽETAK:

Zadana je shema nosive konstrukcije armiranobetonske obiteljske kuće sa svim potrebnim dimenzijama (prilog zadatku). Također su zadana djelovanja na konstrukciju, te za neke elemente nacrtati planove oplata i armature. Statički proračun i armaturne planove izraditi sukladno propisima i pravilima struke.

KLJUČNE RIJEČI:

Armiranobetonska obiteljska kuća, numerički model, statički proračun, plan armature.

ABSTRACT:

The default scheme bearing structures reinforced concrete family house, with all the required dimensions (Annex task). Also the default action on the structure, and for some elements draw plans and reinforcement. Structural analysis and reinforcement plans develop in accordance with the regulations and rules of the profession.

KEYWORDS:

Reinforced concrete family house, numerical model, static analysis, reinforcement plan

1. TEHNIČKI OPIS.....	10
2. GEOMETRIJSKE KARAKTERISTIKE NOSIVIH ELEMENATA	11
3. ANALIZA OPTEREĆENJA	13
3.1. POZICIJA 200 – KROV.....	13
3.1.1. Stalno opterećenje.....	13
3.1.2. Uporabno opterećenje.....	13
3.2. POZICIJA 100 – ETAŽA.....	15
3.2.1. Stalno opterećenje.....	15
3.2.2. Uporabno opterećenje.....	15
3.3. STUBIŠTE.....	18
3.3.1. Stalno opterećenje.....	18
3.3.2. Uporabno opterećenje.....	19
3.4. OPTEREĆENJE VJETROM	20
4. PRORAČUN PLOČE POZICIJE 200	27
4.1. MOMENTI SAVIJANJA U PLOČI POZICIJE 200	27
4.1.1. Vlastita težina.....	27
4.1.2. Dodatno stalno opterećenje	28
4.1.3. Uporabno opterećenje.....	28
4.1.4. Granično stanje nosivosti.....	29
4.2. DIMENZIONIRANJE PLOČE POZICIJE 200 (KROV)	31
5. PRORAČUN PLOČE POZICIJE 100	34
5.1. MOMENTI SAVIJANJA U PLOČI POZICIJE 100	34
5.1.1. Vlastita težina.....	34
5.1.2. Dodatno stalno opterećenje	35
5.1.3. Uporabno opterećenje	36
5.1.4. Granično stanje nosivosti.....	Pogreška! Knjižna oznaka nije definirana.
5.2. DIMENZIONIRANJE PLOČE POZICIJE 100	38
6. PRORAČUN KONTINUIRANOG NOSAČA	POGREŠKA! KNJIŽNA OZNAKA NIJE
DEFINIRANA.	
6.1. MOMENTI SAVIJANJA I POPREČNE SILE GREDE	POGREŠKA! KNJIŽNA OZNAKA NIJE
DEFINIRANA.	
6.1.1. Vlastita težina.....	Pogreška! Knjižna oznaka nije definirana.
6.1.2. Dodatno stalno opterećenje	Pogreška! Knjižna oznaka nije definirana.
6.1.3. Uporabno opterećenje.....	Pogreška! Knjižna oznaka nije definirana.
6.1.4. Granično stanje nosivosti.....	Pogreška! Knjižna oznaka nije definirana.
6.2. DIMENZIONIRANJE NA MOMENT SAVIJANJA	POGREŠKA! KNJIŽNA OZNAKA NIJE
DEFINIRANA.	

6.3.	DIMENZIONIRANJE NA POPREČNU SILU . POGREŠKA! KNJIŽNA OZNAKA NIJE DEFINIRANA.	
6.4.	KONTROLA PUKOTINA GREDE POGREŠKA! KNJIŽNA OZNAKA NIJE DEFINIRANA.	
6.5.	KONTROLA PROGIBA GREDE POGREŠKA! KNJIŽNA OZNAKA NIJE DEFINIRANA.	
7.	PRORAČUN STUBIŠTA.....	54
7.1.	MJERODAVNE REZNE SILE..... POGREŠKA! KNJIŽNA OZNAKA NIJE DEFINIRANA.	
7.2.	DIMENZIONIRANJE STUBIŠTA	55
8.	PRORAČUN ZIDOVA	56
8.1.	POMACI.....	58
8.1.1.	<i>Prostorni model</i>	58
8.1.2.	<i>Štapni model</i>	60
8.2.	MOMENTI SAVIJANJA I UZDUŽNE SILE STUPOVA.....	58
8.2.1.	<i>Kombinacija 1</i>	58
8.2.2.	<i>Kombinacija 2</i>	60
8.3.	DIMENZIONIRANJE ZIDA.....	62
9.	PRORAČUN TEMELJA	56
9.1.	DIMENZIONIRANJE TEMELJA.....	63
9.2.	KONTROLA NAPREZANJA NA DODIRNOJ PLOHI TEMELJ – TLO.....	65
9.3.	PRORAČUN ARMATURE TEMELJA	66
10.	PRILOZI.....	69
10.1.	ARMATURA PLOČE POZICIJA 100- DONJA ZONA	69
10.2.	ARMATURA PLOČE POZICIJA 100- GORNJA ZONA	69
10.3.	ARMATURA PLOČE POZICIJA 200- DONJA ZONA	69
10.4.	ARMATURA PLOČE POZICIJA 200- GORNJA ZONA	69
10.5.	ARMATURNI PLAN GREDE	69
10.6.	ARMATURNI PLAN STUBIŠTA	69
11.	LITERATURA	77

1. TEHNIČKI OPIS

Predmet ovog rada je projekt armiranobetonske nosive konstrukcije obiteljske kuće. Predmetna građevina sastoji se od prizemlja i kata. Završna ploča kata je ujedno i ravni krov građevine.

Visina građevine iznosi 7,00 m, a tlocrtna površina građevine iznosi 10,75 x 7,95 m.

Nosiva konstrukcija objekta je okvirna, a čine je zidovi i grede iznad koje je armiranobetonska ploča. Stupovi se oslanjaju na trakaste temelje. Rezne sile u pločama i gredama dobivene su pomoću programa *AspalathosLinear*, a korišten je ravninski model. Sve armiranobetonske ploče su debljine $d=14.0\text{cm}$. Grede su dimenzija $b/h=20/40\text{ cm}$. Rezne sile u zidovima za različite kombinacije opterećenja dobivene su pomoću programa *AspalathosLinear*, a korišten je prostorni model (okvir). Odabrane su dimenzije zidova debljine 25 cm i trakastih temelja širine 65 cm. Za vertikalnu komunikaciju između katova predviđeno je armirano-betonsko stepenište debljine nosive ploče $d=17.0\text{ cm}$.

Izračunato stalno opterećenje za poziciju 200(krov) iznosi $7,03\text{ kN/m}^2$, a uporabno opterećenje (prema propisima) iznosi $1,0\text{ kN/m}^2$. Zadano je uporabno opterećenje za poziciju 100 i iznosi $3,5\text{ kN/m}^2$, stalno opterećenje je $6,70\text{ kN/m}^2$. Građevina se nalazi u III. vjetrovnoj zoni s dozvoljenom brzinom vjetra $v_{b0}=35\text{ m/s}$.

Dozvoljeno naprezanje u tlu na dubini temeljenja iznosi $\sigma_{dop}=0.50\text{ Mpa}$.

Za nosivu armiranobetonsku konstrukciju odabran je beton C 30/37 i čelik za armiranje B500B.

Za sve armiranobetonske nosive elemente izvršen je proračun za granično stanje nosivosti, a za neke elemente izvršena je provjera graničnog stanja uporabljivosti. Na osnovi proračunskih vrijednosti momenata i dobivenih površina armature, te odabranih mrežai šipaka napravljeni su armaturni planovi za neke elemente konstrukcije. Svi nacrti i prikazi krojenja armaturnih mreža ploče, grede i zidova nacrtani su pomoću programa AutoCAD priloženi su u radu.

Statički sustav i armaturni planovi izrađeni su sukladno propisima i pravilima struke.

2. GEOMETRIJSKE KARAKTERISTIKE NOSIVIH ELEMENATA

-visina ploče:

$$d_{pl} = \frac{L_x}{35} = \frac{475}{35} = 13,57 \quad \text{PRESJEK 1}$$

$$\Rightarrow \text{odabrano: } d_{pl} = 14 \text{ cm}$$

visina grede:

$$\frac{L_0}{12} = \frac{L_1}{12} = \frac{480}{12} = 40,0 \text{ cm}$$

$$\text{odabrano : } h_G = 40,0 \text{ cm}$$

-širina grede:

$$\frac{h_{G1}}{2} = \frac{40}{2} = 20 \text{ cm}$$

$$\text{odabrano : } b_G = 20 \text{ cm}$$

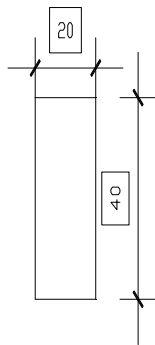

Parametri materijala C30/37

E	32500	N/mm ²
G	13541,6666666667	N/mm ²
v	0,2	
ρ	2,5E-5	N/mm ³
α	1E-5	°C ⁻¹

C30/37

A $A_x = 800,00 \text{ cm}^2$

A $A_y = 800,00 \text{ cm}^2$

A $A_z = 800,00 \text{ cm}^2$

A $I_y = 26666,6667 \text{ cm}^4$

A $I_z = 106666,6667 \text{ cm}^4$

Slika 2.1. Poprečni presjek grede

- Za sve nosive elemente u x i y smjeru na pozicijama 100 i 200 odabran je isti presjek grede, dimenzija 40x20 cm.

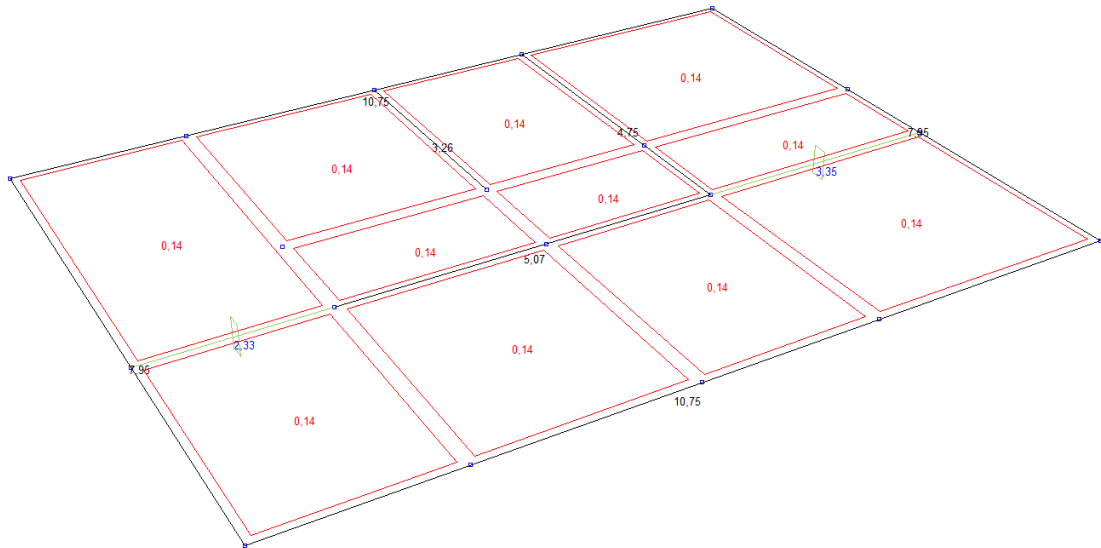

40/20

Slika 2.2. Prikaz dimenzija greda i ploča poz. 200

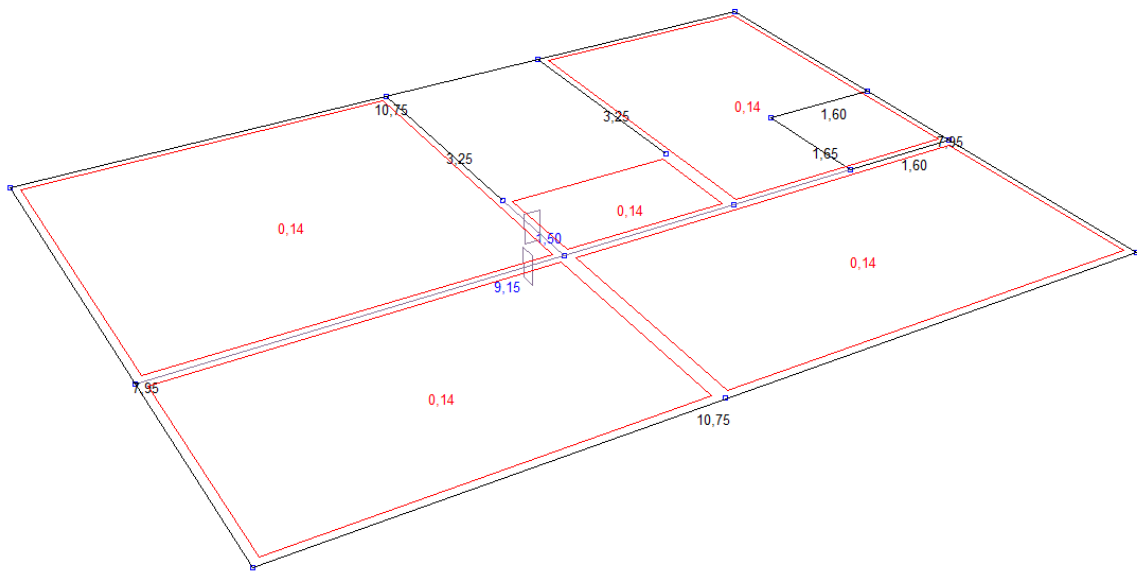

40/20

Slika 2.3. Prikaz dimenzija greda i ploča poz. 100

3. ANALIZA OPTEREĆENJA

3.1 POZICIJA 200 – KROV

3.1.1. Stalno opterećenje

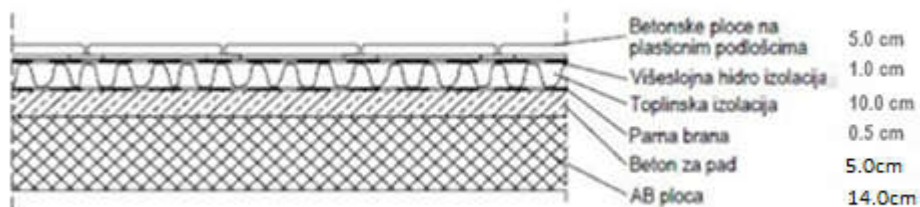

Slika 3.1. Presjek ploče poz. 200

Tablica 3.1. Stanlno opterećenje poz.200

	d (m)	γ (kN/m ³)	d· γ (kN/m ²)
Betonske ploče na plastičnim podloščima	0.05	25.0	1.25
Hidroizolacija + parna brana	0.01	20.0	0.20
Toplinska izolacija	0.10	5.0	0.50
Beton za pad	0.05	24.0	1.20
AB ploča	0.14	25.0	3.50
Cementna žbuka	0.02	19.0	0.38

Ukupno stalno opterećenje: $g_{200} = 7.03$ (kN/m²)

3.1.2. Uporabno opterećenje

Za uporabno opterećenje uzima se opterećenje snijegom i vjetrom. Opterećenje snijegom za ravnekrovove, u područjima gdje je snijeg rijedak (prema pravilniku) iznosi 0.50 kN/m², pa se za uporabno opterećenje neprohodnih ravnih krovova može uzeti zamjenjujuća vrijednost:

$$q_{200} = s + w \approx 1.0 \text{ kN/m}^2$$

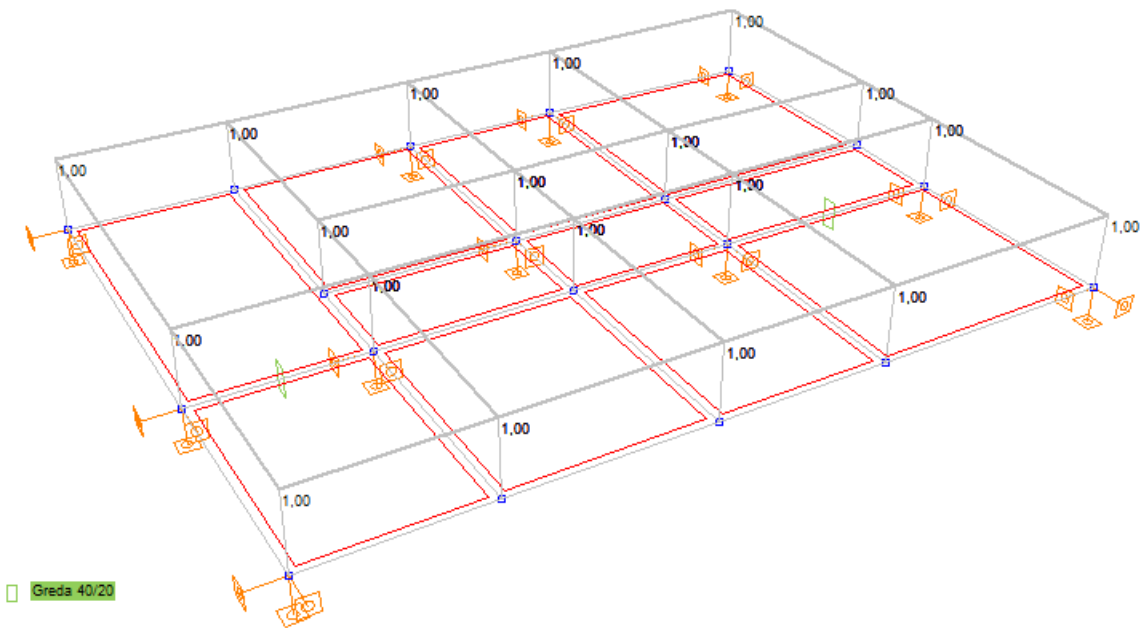
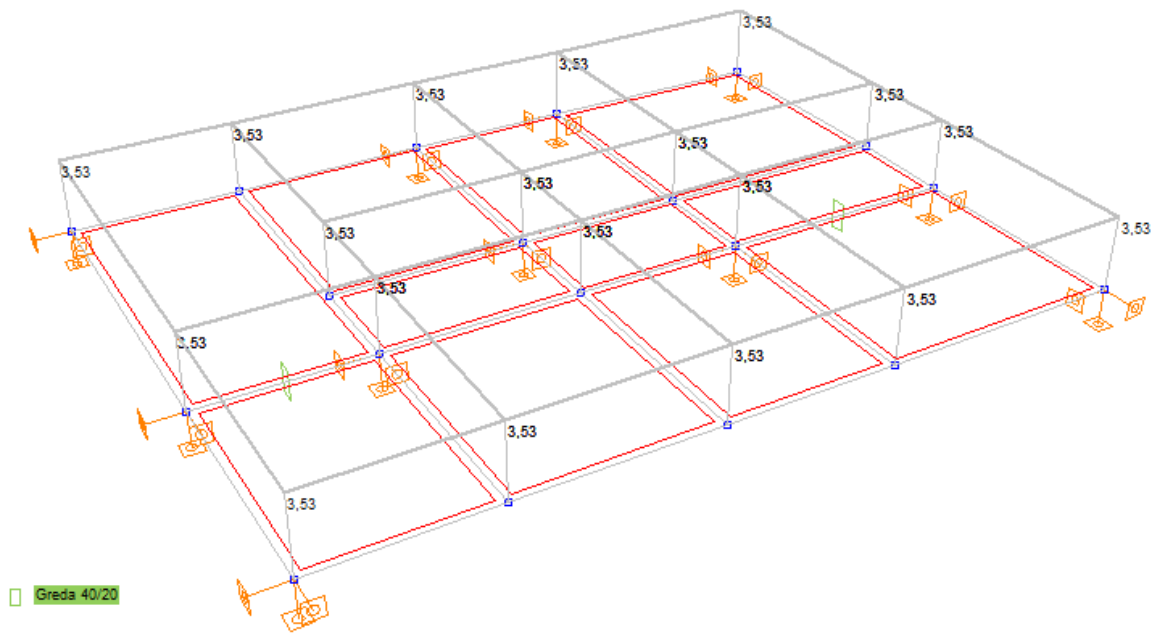

Slika 3.2. Prikaz dodatnog stalnog opterećenja G_0 i korisnog opterećenja Q

3.2. POZICIJA 100 – ETAŽA

3.2.1. Stalno opterećenje

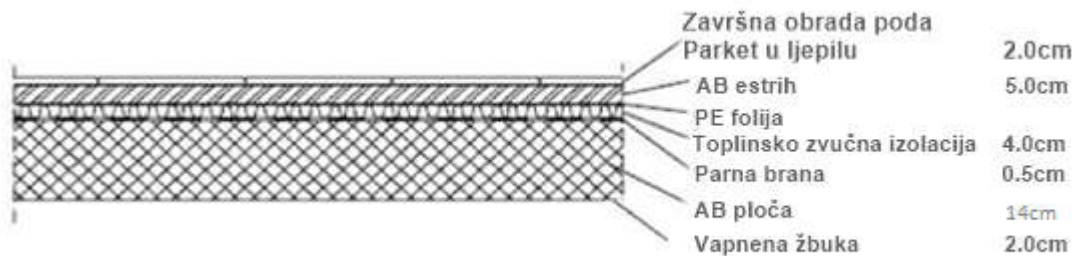

Slika 3.3. Presjek ploče poz. 100

Tablica 3.2. Stalno opterećenje poz. 100

	d (m)	γ (kN/m ³)	d· γ (kN/m ²)
Pregrade			1.00
Završna obrada poda-parket	0.02	12.0	0.24
AB estrih	0.05	25.0	1.25
Toplinska izolacija	0.04	5.0	0.20
Hidroizolacija	0.005	20.0	0.10
AB. Ploča	0.14	25.0	3.50
Pogled (vapnena žbuka)	0,02	19,00	0,38

Ukupno stalno opterećenje $g_{100} = 6,70$ (kN/m²)

3.2.2. Uporabno opterećenje

Uporabno opterećenje se uzima prema pravilniku: HRN EN 1991-2-1.

U našem slučaju, zadano je zadatkom $q_{100} = 3.5$ kN/m²

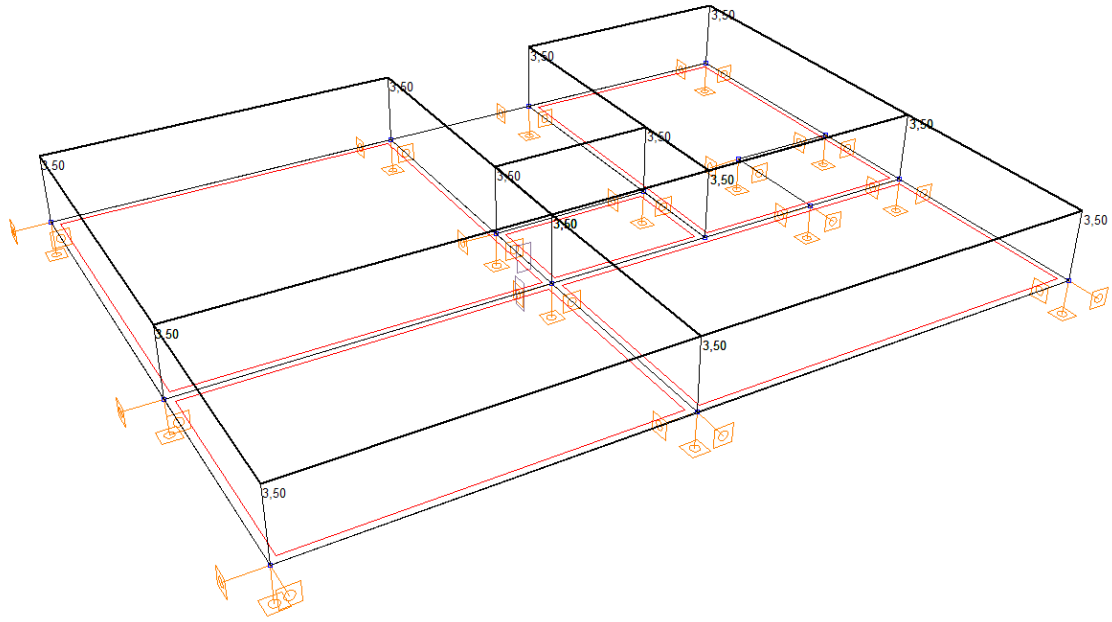

40/20

Slika 3.6 Prikaz uporabnog opterećenja Q

3.3. STUBIŠTE

3.3.1. Stalno opterećenje

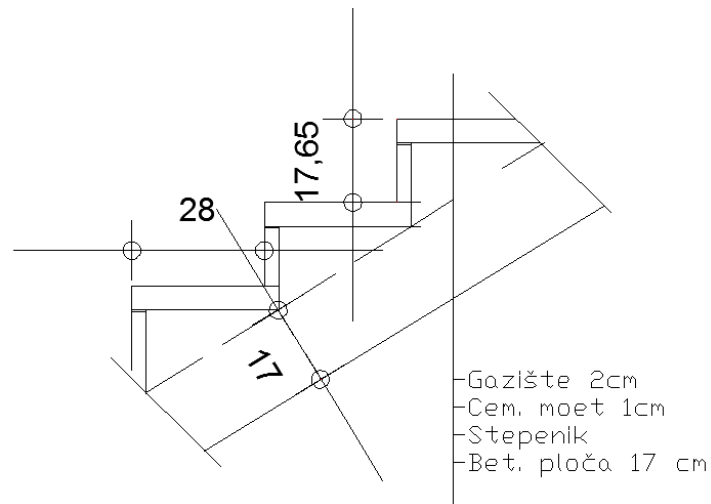

Slika 3.7. Presjek stubišta

- Broj stuba :

$$n s = H/v = 3,00/0,1765 = 17 \text{ stuba}$$

- Širina stube:

$$2 \cdot v_s + \text{šs} = 63 \Rightarrow \text{šs} = 63 - 2 \cdot 0,1765 = 28 \text{ cm}$$

- Duljina kraka:

$$L_k = n s \cdot \text{šs} = 7 \cdot 28 = 196 \text{ cm}$$

- Kut α :

$$\text{tg} \alpha = 0,5 \cdot H/L_k = 1,5 \cdot 3,3 = 0,765 \Rightarrow$$

$$\alpha = 39,1^\circ$$

- Odabrana duljina podesta:

$$L_p \geq 1,20 \text{ m} \quad L_p = (L - L_k)/2 = (6,9 - 3,3)/2 = 1,20 \text{ m}$$

$$h' = h/\cos \alpha = 17/\cos 39,1 = 19,87 \text{ cm}$$

Tablica 3.3. Stalno opterećenje stubišta

	d (m)	γ (kN/m ³)	d· γ (kN/m ²)
Završna obrada gazišta – kamena ploča	0.02	28.0	0.56
Cementni namaz (max. 1,0 cm)	0.01	20.0	0.20
Stuba	0.075	24.0	1.80
AB ploča (h'= cm)	0.199	25.0	4.96

Ukupno stalno opterećenje : $g_{st} = 7,52$ (kN/m²)

3.3.2. Uporabno opterećenje

Uporabno opterećenje se uzima prema pravilniku: HRN EN 1991-2-1.

U našem slučaju, uzet ćemo ga jednako kao na pločama:

$$q_{st} = 4,95 \text{ (kN/m}^2\text{)}$$

3.4. OPTEREĆENJE VJETROM

Dimenzije zgrade su: $D=10,75\text{m}$, $\mathring{S}=7,95\text{m}$, $H=7,00\text{m}$.

Objekt se nalazi u III. vjetrovnoj zoni, na visini od 150 m.n.m

Osnovna brzina vjetra: $v_{b,0} = 35 \text{ m/s}$ (za III. Zonu)

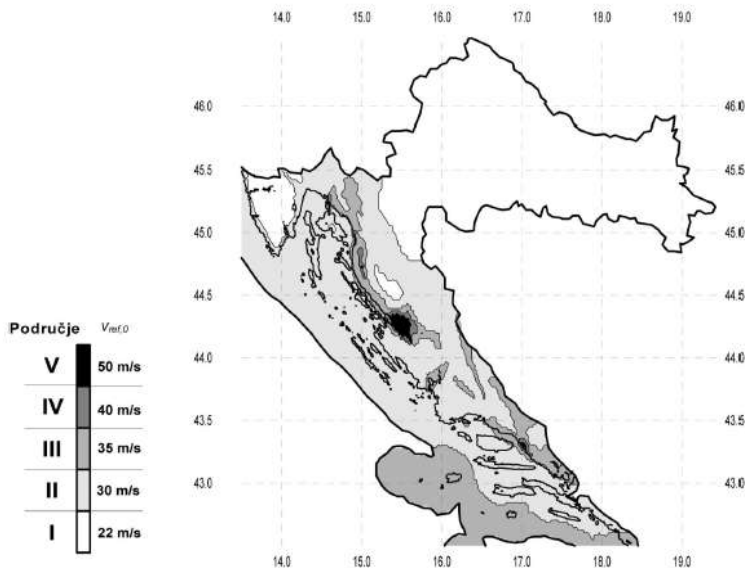

Slika 3.8. Zemljovid područja opterećenja vjetrom

Referentna brzina vjetra: $v_b = c_{DIR} \cdot c_{TEM} \cdot c_{ALT} \cdot v_{b,0}$

c_{DIR} - koeficijent smjera vjetra $\rightarrow c_{DIR} = 1,0$

c_{TEM} - koeficijent ovisan o godišnjem dobu $\rightarrow c_{TEM} = 1,0$

c_{ALT} - koeficijent nadmorske visine $\rightarrow c_{ALT} = 1 + 0,0001 \cdot a_s$

$$c_{ALT} = 1 + 0,0001 \cdot 150 = 1,015$$

$$v_b = 1,00 \cdot 1,00 \cdot 1,015 \cdot 35 = 35,525 \text{ m/s}$$

Zgrada ima veću širinu od visine, a za mjerodavnu visinu uzimamo ukupnu visinu. Mjerodavna visina iznosi: 7,00

Mjerodavna visina je veća od minimalne (2,00 m), pa je koeficijent hrapavosti:

$$c_{r(z)} = k_r \cdot \ln \left(\frac{z_g}{z_0} \right)$$

Koeficijent terena k_r određuje se iz odgovarajuće tablice ovisno o kategoriji zemljišta. Odabiremo III. kategoriju zemljišta.

Tablica 3.4. Kategorije terena i pripadni parametri

Kategorija terena	Opis	K_r	z_0 [m]	Z_{min} [m]
0	More ili područje uz more otvoreno prema moru	0.156	0.003	1
I	Uzburkano otvoreno more ili jezero, s najmanje 5 km dužine navjetrine i gladak ravan teren bez prepreka	0.170	0.01	1
II	Poljoprivredno zemljište s ogradama, povremenim malim poljoprivrednim objektima, kućama ili drvećem	0.190	0.05	2
III	Predgrađa ili industrijske zone i stalne šume	0.215	0.30	5
IV	Urbane zone u kojima je najmanje 15% površine pokriveno zgradama čija je srednja visina veća od 15 m	0.234	1.00	10

$$k_r=0,215 \rightarrow c_{r(z)} = 0,215 \cdot \ln(7,00/0,30)=0,677$$

$$\text{Srednja brzina vjetra tako iznosi: } V_{ms}(z) = C_r(z) \cdot C_0(z) \cdot V_b$$

C_0 - koeficijent topografije (uglavnom se uzima 1.0)

$$v_m = 0,677 \cdot 1,0 \cdot 35,525 = 24,050 \text{ m/s}$$

Turbulencija:

$$I_v(z) = 1 / c_0(z) \cdot \ln(z_c/z_0) = 1/1,0 \cdot \ln(7,00/0,30) = 0,317$$

Maksimalni tlak brzine vjetra $q_p(z_e)$:

$$\rho_{zr} = 1,25 \text{ kg/m}^3$$

$$q_p(z) = [1 + 7 \cdot I_v(z)] \cdot \frac{\rho_{zr}}{2} \cdot v_m^2(z) = c_e(z) \cdot v_b^2(z)$$

$$q_p(z) = (1 + 7 \cdot 0,317) \cdot 1,25 / 2 \cdot 24,050^2 = 1163,67 \text{ N/m}^2 = 1,16 \text{ kN/m}^2$$

Djelovanje na zgradu:

$$W_{1,e}=0,8*q_p(z)=0,8*1,16=0,928 \text{ kN/m}^2$$

$$W_{2,e}=0,5*q_p(z)=0,5*1,16=0,580 \text{ kN/m}^2$$

$$W_{1,i}=0,75*w_{1,e}=0,75*0,928=0,696 \text{ kN/m}^2$$

$$W_{2,i}=0,75*w_{2,e}=0,75*0,580=0,435 \text{ kN/m}^2$$

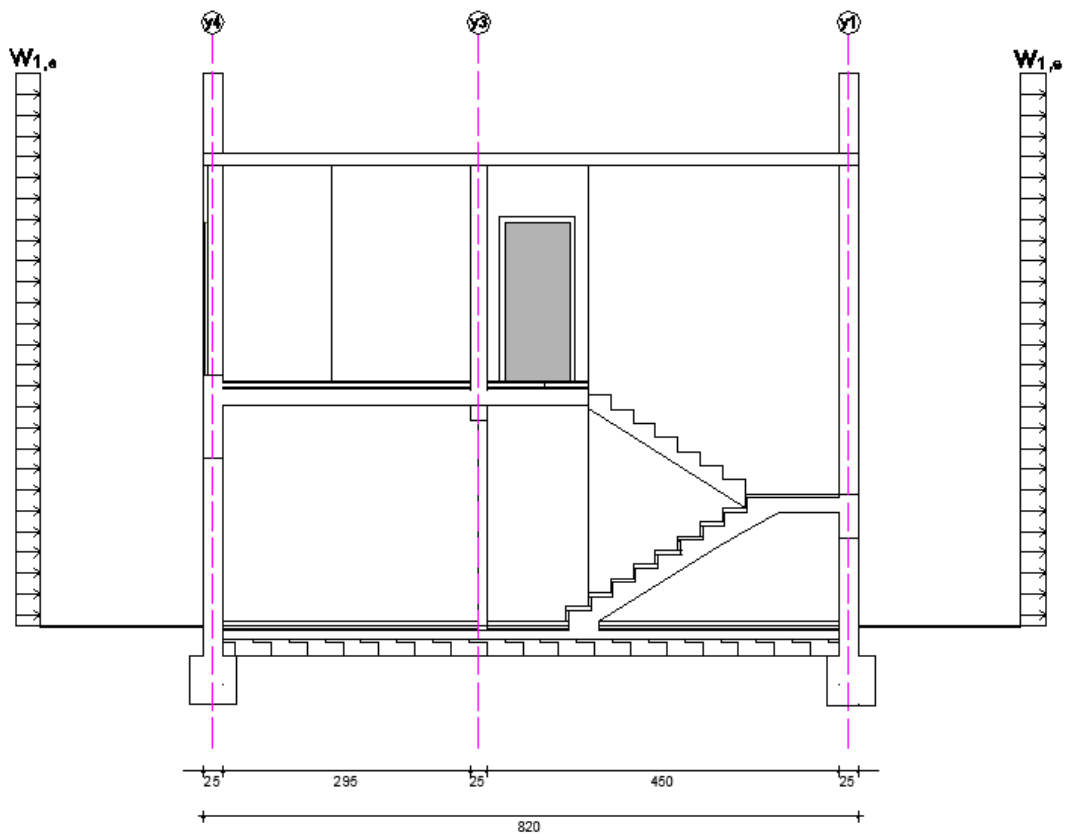

Slika 3.9. Opterećenje vjetrom

Silu vjetra zadajemo u čvorovima modela. Određivanje sila u čvorovima modela vršimo prema utjecajnim površinama djelovanja vjetra.

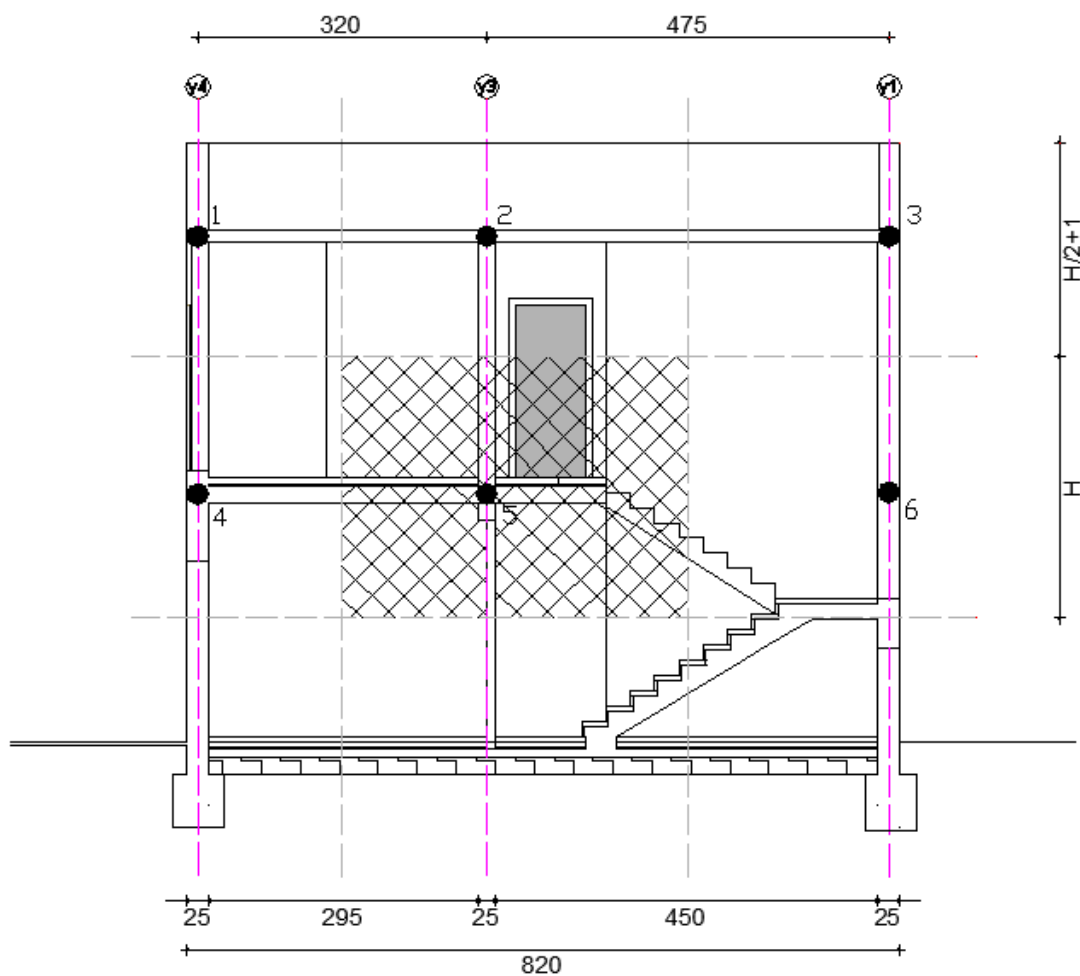

Slika 3.10. Utjecajne površine djelovanja vjetra

➤ **X smjer**

Tablica 3.5. Lijevi bok

Čvor	Utjecajna površina			Tlak vjetra(kN/m ²)	Sila u čvoru(kN)
	Širina(m)	Visina(m)	Površina(m ²)		
1	1.60	2.5	4.00	0.928	3.71
2	3.975	2.5	9.94	0.928	9.22
3	2.375	2.5	5.94	0.928	5.51
4	1.60	3.0	4.80	0.928	4.45
5	3.975	3.0	11.93	0.928	11.07
6	2.375	3.0	7.13	0.98	6.62

Tablica 3.6. Desni bok

Čvor	Utjecajna površina			Tlak vjetra(kN/m ²)	Sila u čvoru(kN)
	Širina(m)	Visina(m)	Površina(m ²)		
1	1.60	2.5	4.00	0.58	2.32
2	3.975	2.5	9.94	0.58	5.77
3	2.375	2.5	5.94	0.58	3.45
4	1.60	3.0	4.80	0.58	2.78
5	3.975	3.0	11.93	0.58	6.92
6	2.375	3.0	7.13	0.58	4.14

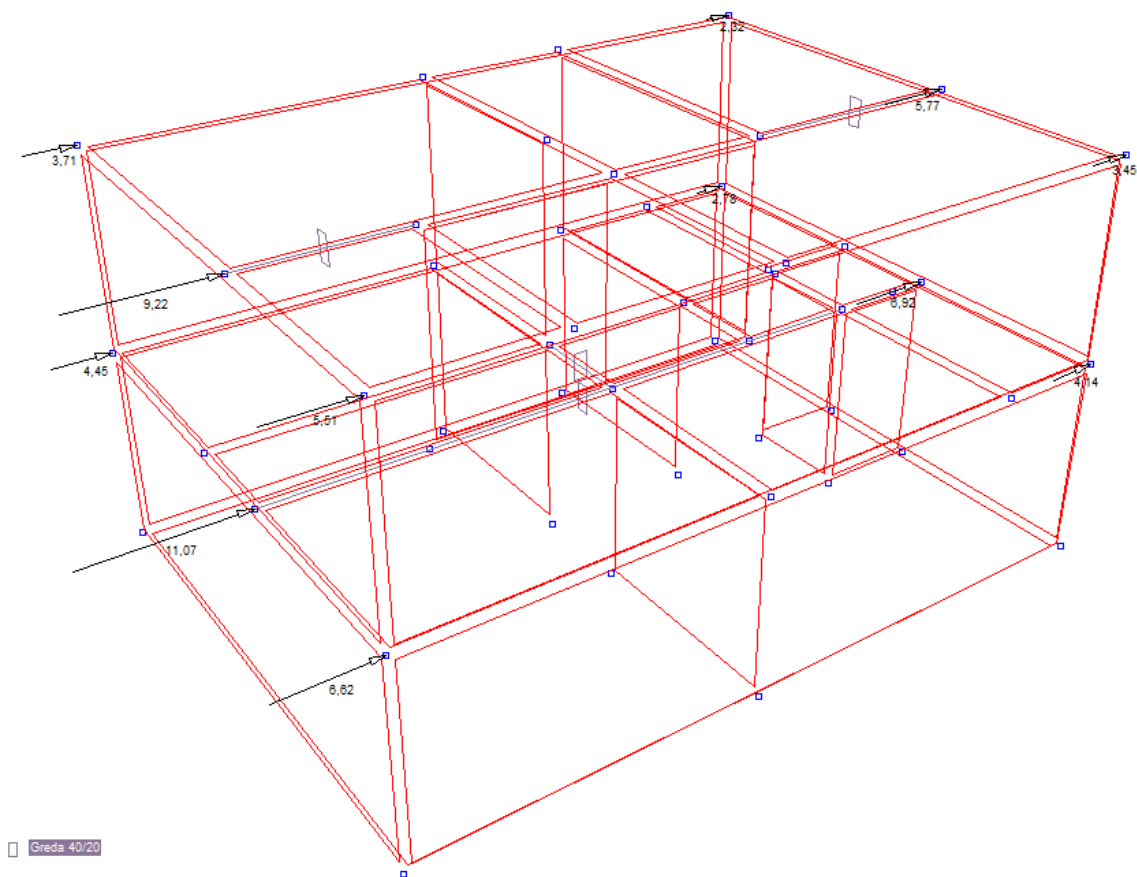

Slika 3.11. Djelovanje vjetra u X smjeru (sile u kN)

➤ **Y smjer**

Tablica 3.7. Prednja strana

Čvor	Utjecajna površina			Tlak vjetra(kN/m ²)	Sila u čvoru(kN)
	Širina(m)	Visina(m)	Površina(m ²)		
1	2.525	2.5	6.313	0.928	7.35
2	5.375	2.5	13.438	0.928	12.47
3	2.85	2.5	7.125	0.928	6.61
4	2.525	3.0	7.575	0.928	7.03
5	5.375	3.0	16.125	0.928	14.96
6	2.85	3.0	8.55	0.928	7.93

Tablica 3.8. Stražnja strana

Čvor	Utjecajna površina			Tlak vjetra(kN/m ²)	Sila u čvoru(kN)
	Širina(m)	Visina(m)	Površina(m ²)		
1	3.45	2.5	6.313	0.58	3.66
2	6.90	2.5	13.438	0.58	7.79
3	6.90	2.5	7.125	0.58	4.13
4	3.45	3.0	7.575	0.58	4.39
5	3.45	3.0	16.125	0.58	9.35
6	6.90	3.0	8.55	0.58	4.96

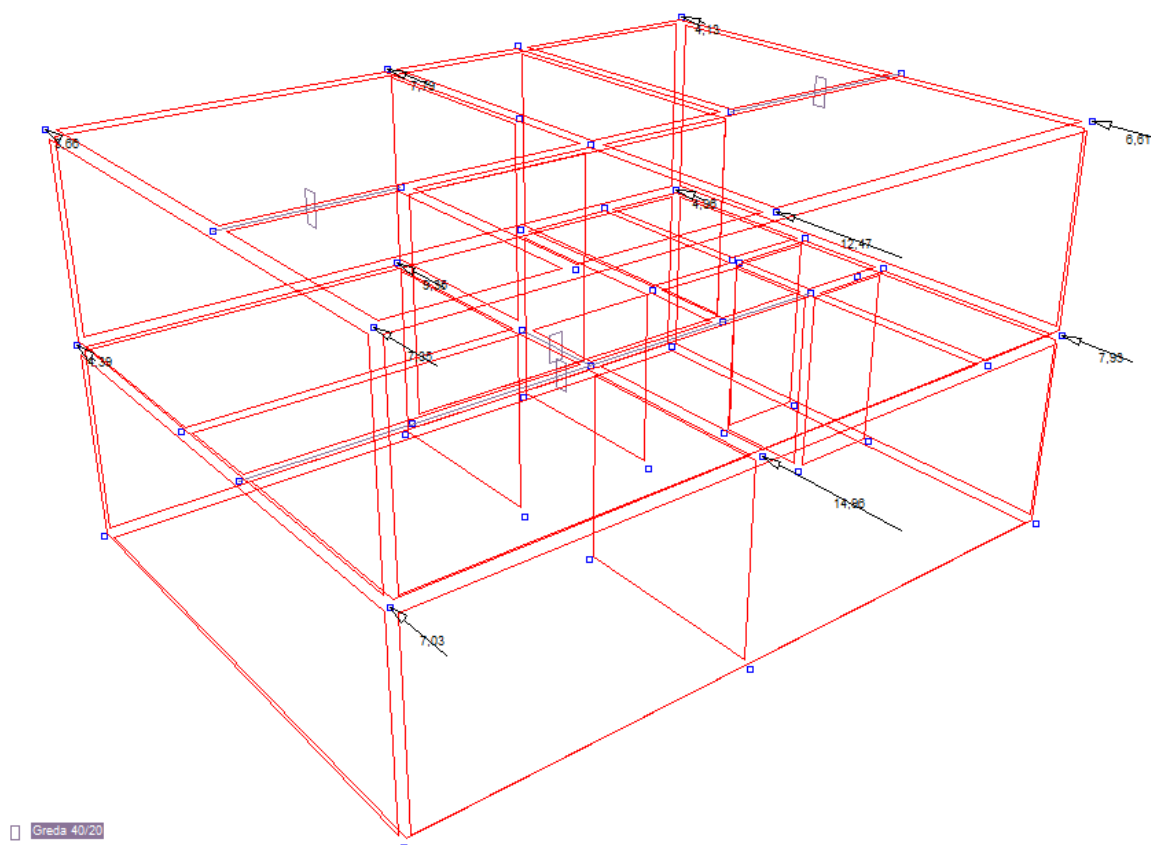

Slika 3.12. Djelovanje vjetra u Y smjeru (sile u kN)

4. PRORAČUN PLOČE POZICIJE 200

- Proračun reznih sila vršio se kompjuterskim programom *AspalathosLinear*. Prikaz rezultata dan je odvojeno za ploče i grede.

4.1. MOMENTI SAVIJANJA U PLOČI POZICIJE 200

4.1.1 *Vlastita težina*

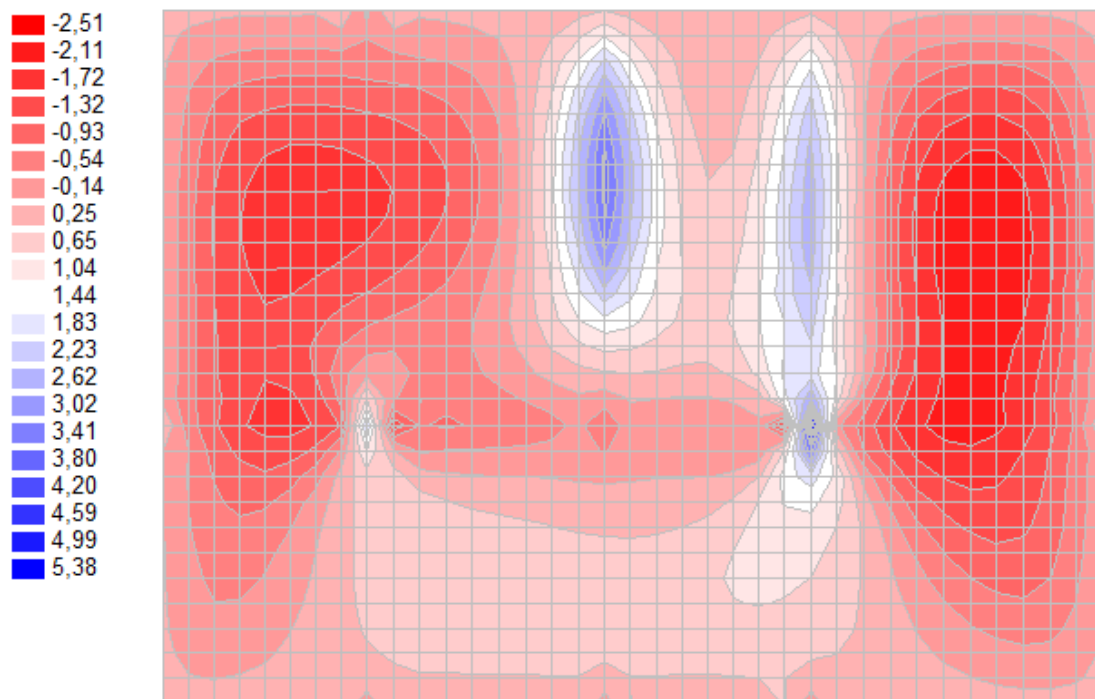

Slika 4.1. Momenti M_x (kNm)

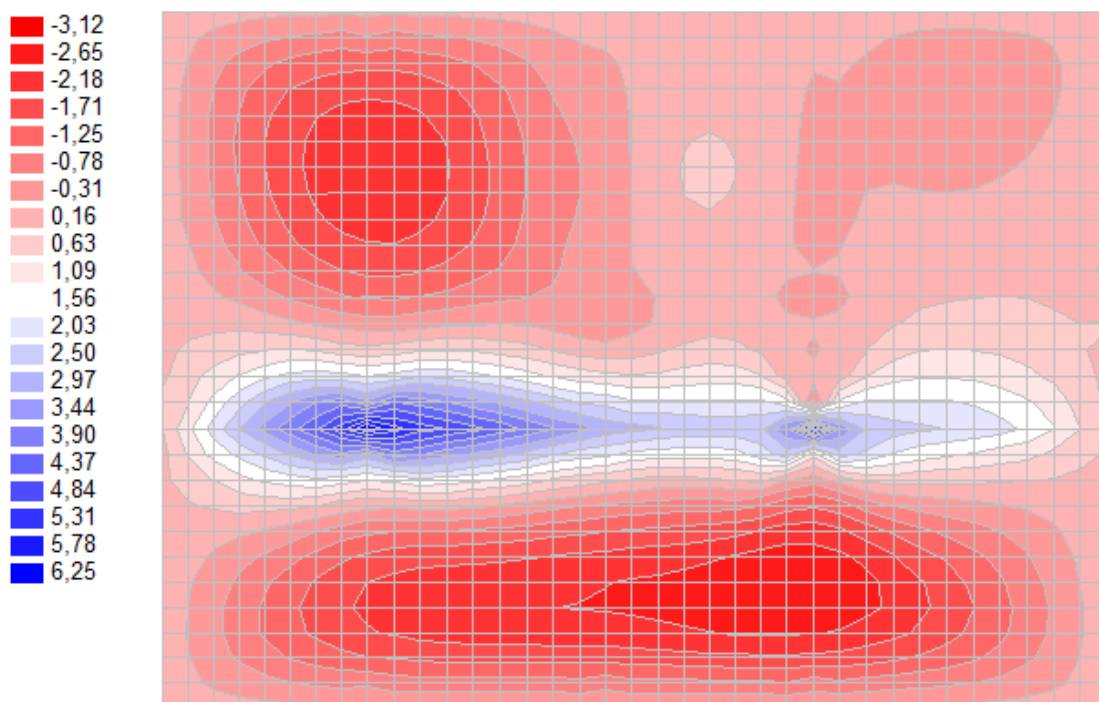

Slika 4.2. Momenti M_y (kNm)

4.1.2. Dodatno stalno opterećenje

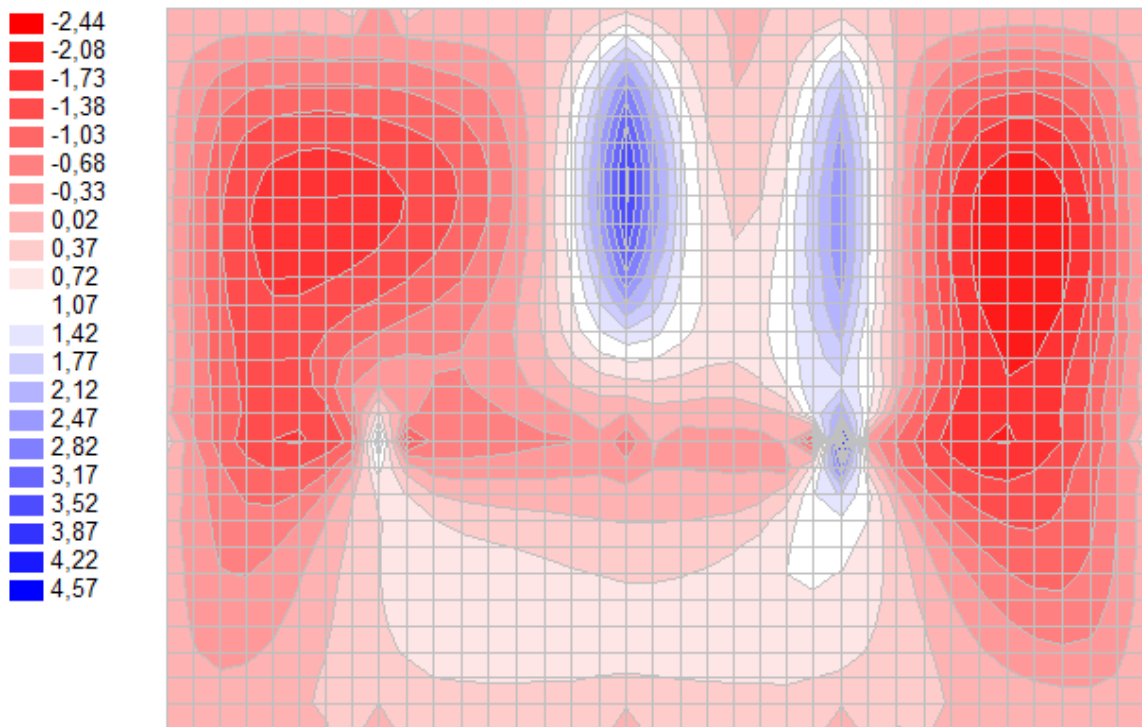

Slika 4.3. Momenti M_x (kNm)

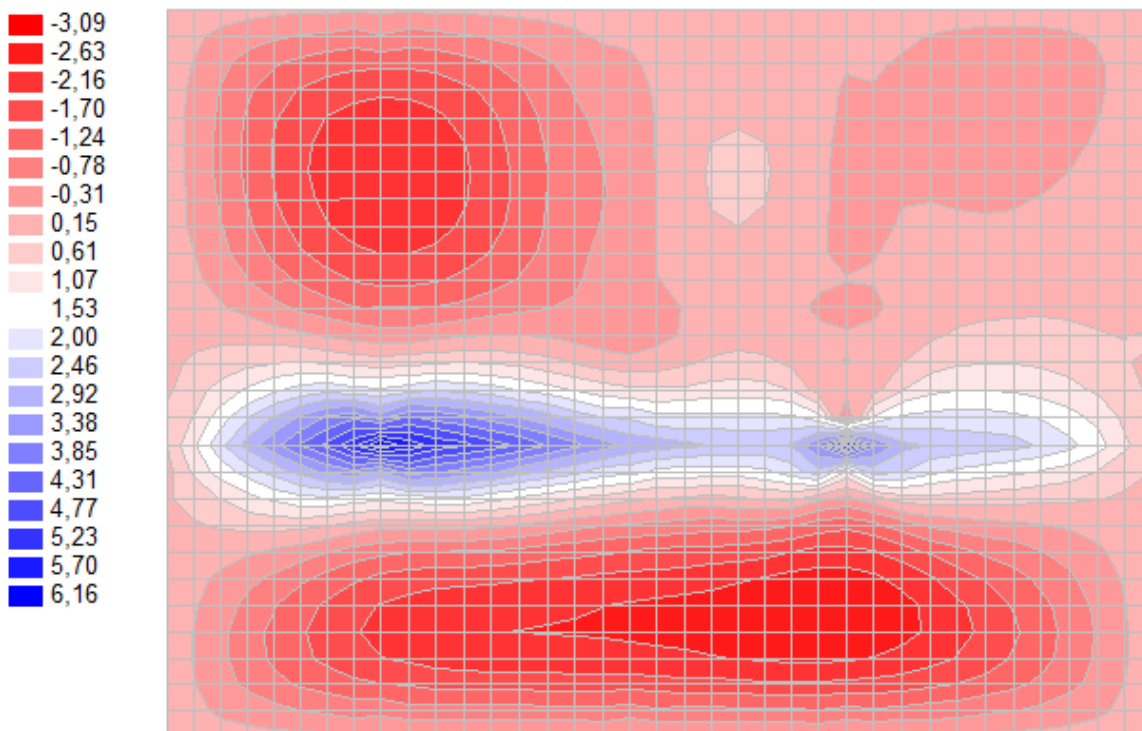

Slika 4.4. Momenti M_y (kNm)

4.1.3 Uporabno opterečenje

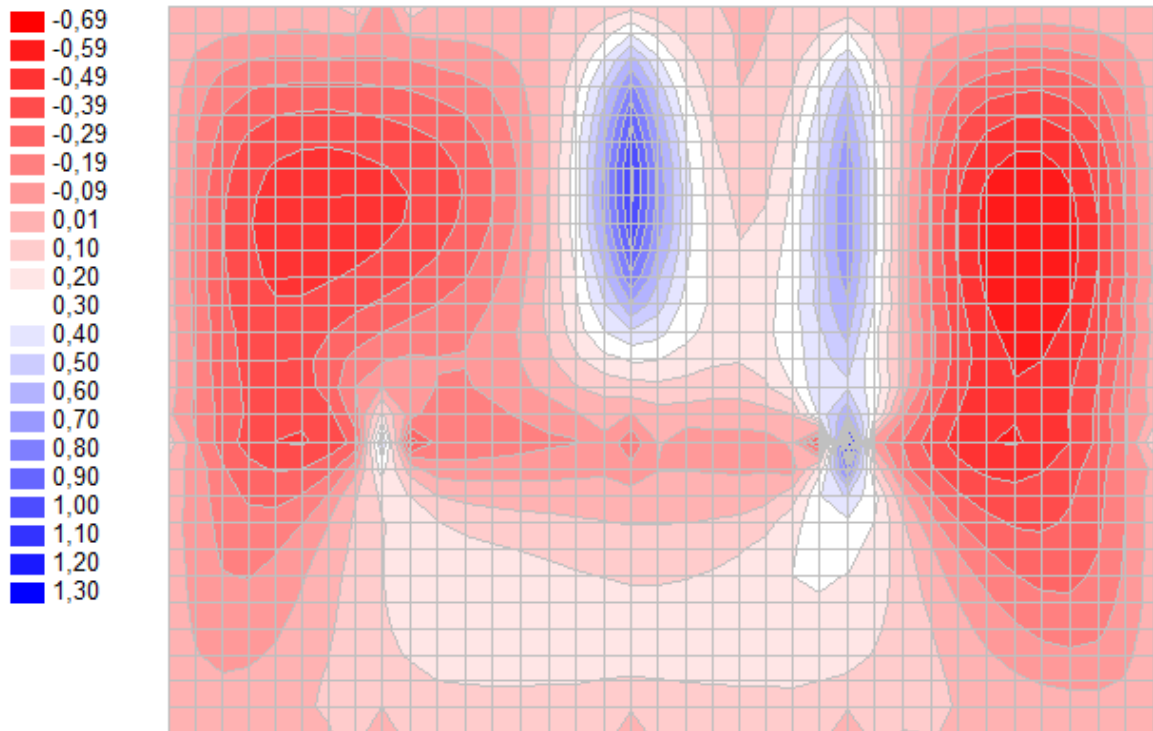

Slika 4.5. Momenti M_x (kNm)

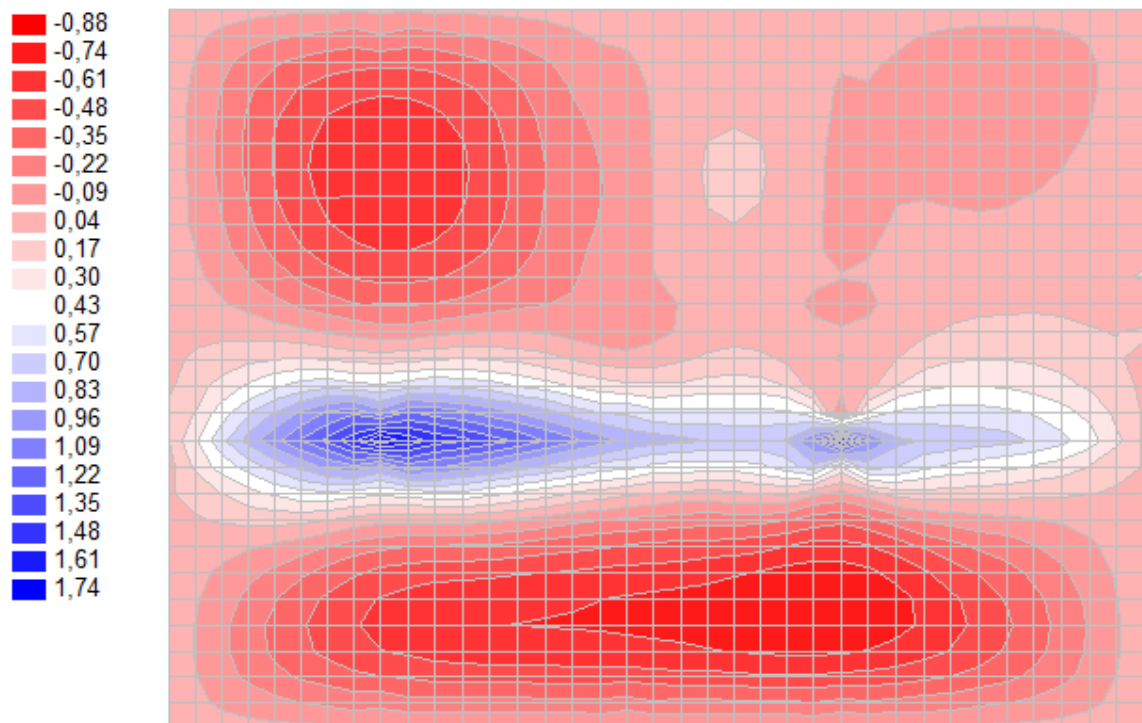

Slika 4.6. Momenti M_y (kNm)

4.1.4. Granično stanje nosivosti

Mjerodavna kombinacija: $M_{sd}=1,35*(M_g+M_{\Delta g})+1,5*M_q$

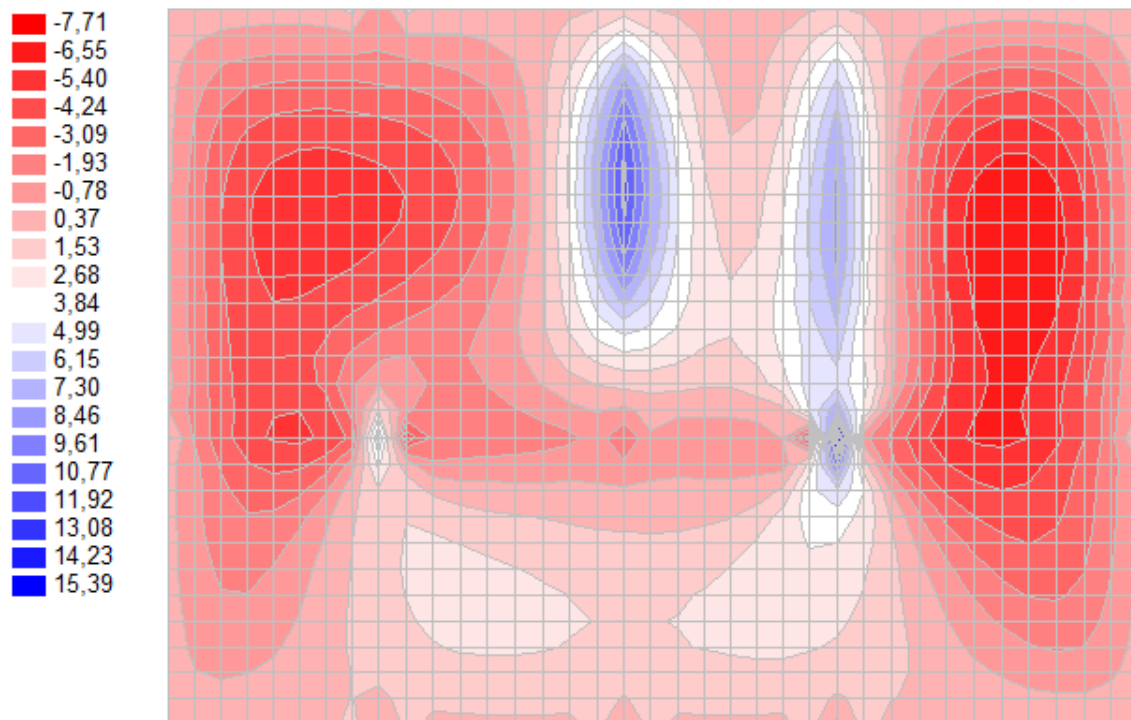

Slika 4.7. Momenti M_x (kNm)

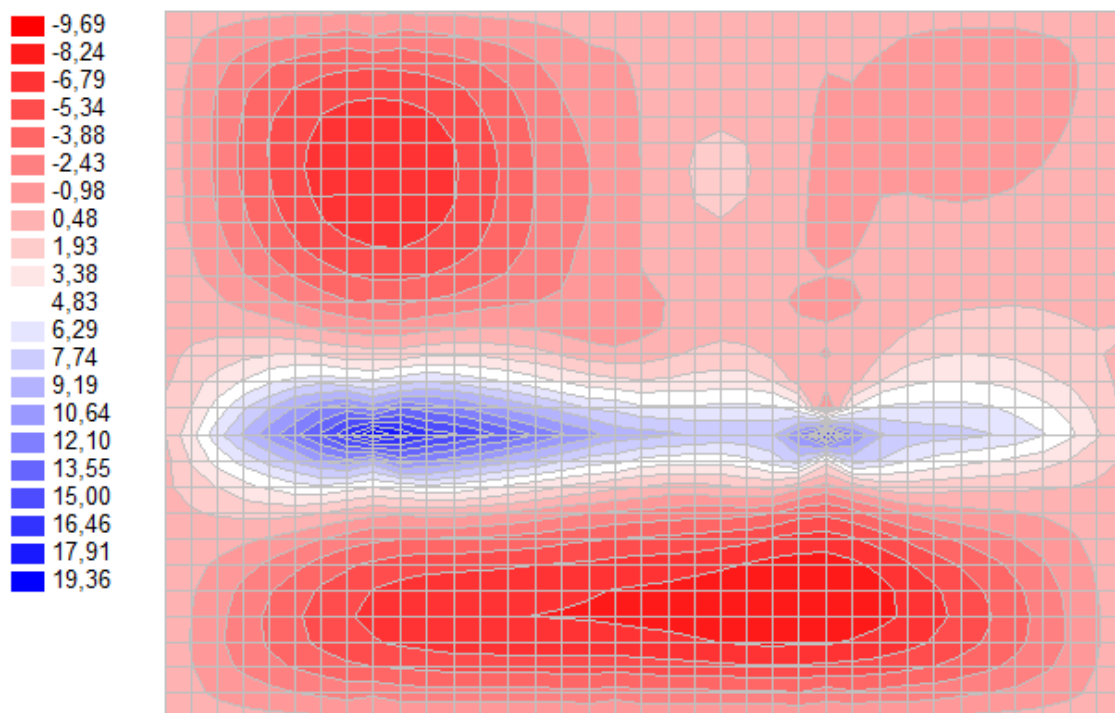

Slika 4.8. Momenti M_y (kNm)

4.2. DIMENZIONIRANJE PLOČE POZICIJE 200 (krov)

BETON: C 30/37;

$$f_{ck} = 30,0 \text{ MPa} = 30,0 \text{ N/mm}^2; \gamma_c = 1,5$$

$$f_{cd} = f_{ck} / \gamma_c = 20,0 \text{ N/mm}^2 = 2,0 \text{ kN/cm}^2$$

ARMATURA: B 500 B;

$$f_{yk} = 500,0 \text{ MPa} = 500 \text{ N/mm}^2; \gamma_s = 1,15$$

$$f_{yd} = f_{yk} / \gamma_s = 500,0 / 1,15 = 434,78 \text{ MPa} = 434,78 \text{ N/mm}^2 = 43,48 \text{ kN/cm}^2$$

DEBLJINA PLOČE: $h = 14 \text{ cm}$

ZAŠTITNI SLOJ: $c = 3 \text{ cm}$

STATIČKA VISINA PLOČE:

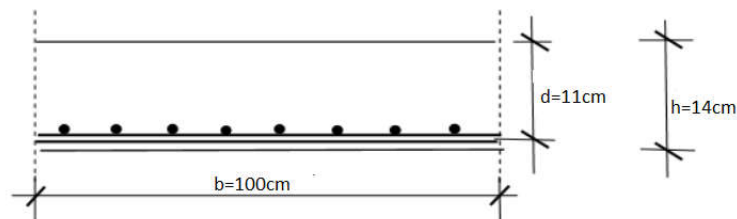

Slika 4.9. Poprečni presjek ploče

$$d = h - d_1$$

$$d_1 = c + \frac{\varnothing}{2} = 2,5 + 0,5 = 3 \text{ cm}$$

$c \rightarrow$ zaštitni sloj

STATIČKA VISINA PLOČE:

$$d = 14 - 3 = 11 \text{ cm}$$

Za sve presjeka odabrana je statička visina ploče $d = 14 \text{ cm}$. Izvršen je proračun armature za kombinaciju :

$$1,35 \times \text{vl.težina} + 1,35 \times \text{dodatno stalno} + 1,5 \times \text{uporabno}$$

Ploča - Polje

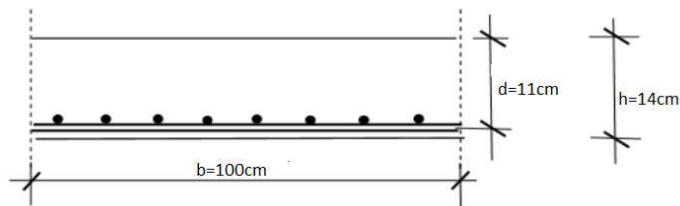

$$M_{Ed} = 9,69 \text{ kNm}$$

$$\mu_{sd} = M_{Ed} / b_{eff} \cdot d^2 \cdot f_{cd} = 969 / 100 \cdot 14^2 \cdot 2,0 = 0,025$$

$$\text{Očitano: } \epsilon_{s1} = 10,0 \text{ ‰} \quad \epsilon_{c2} = 0,9 \text{ ‰} \quad \zeta = 0,971 \quad \xi = 0,083$$

$$A_{s1} = M_{Ed} / \zeta \cdot d \cdot f_{yd} = 969 / 0,971 \cdot 14 \cdot 43,48 = 1,64 \text{ cm}^2/\text{m}$$

ODABRANO: **Q-166** ($A_s = 1,66 \text{ cm}^2/\text{m}$)

Ploča - Ležaj

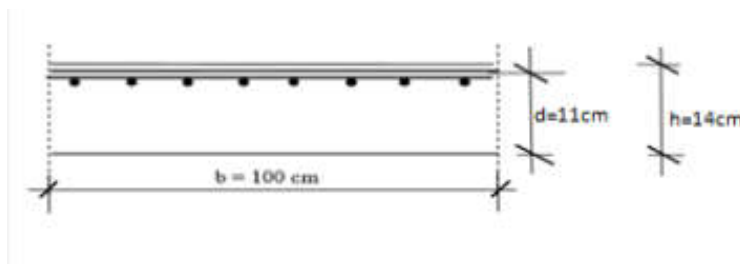

$$M_{Ed} = 19,36 \text{ kNm}$$

$$\mu_{sd} = M_{Ed} / b_{eff} \cdot d^2 \cdot f_{cd} = 1936 / 100 \cdot 14^2 \cdot 2,0 = 0,049$$

$$\text{Očitano: } \epsilon_{s1} = 10,0 \text{ ‰} \quad \epsilon_{c2} = 1,4 \text{ ‰} \quad \zeta = 0,956 \quad \xi = 0,123$$

$$A_{s1} = M_{Ed} / \zeta \cdot d \cdot f_{yd} = 1936 / 0,956 \cdot 14 \cdot 43,48 = 3,33 \text{ cm}^2/\text{m}$$

ODABRANO: **R- 335** ($A_s = 3,35 \text{ cm}^2$) + preklop povećan na 40 cm

$$A_{s1} = A_{s1} \cdot \xi_m + p_m / \xi_m = 3,35 \cdot 215 + 40 / 215 = 3,97 \text{ cm}^2/\text{m}$$

Koeficijenti za proračun potrebne površine armature za ploču:

$$A_{s1} = \frac{M_{Ed}}{\zeta \cdot d \cdot f_{yd}} = \frac{M_{Ed}}{0,9 \cdot 14 \cdot 43,48} = 0,167 \cdot M_{Ed}$$

koef. za stalno opterećenje: $1,35 * 0,167 = 0,225$

koef. za promjenjivo opterećenje : $1,5 * 0,167 = 0,25$

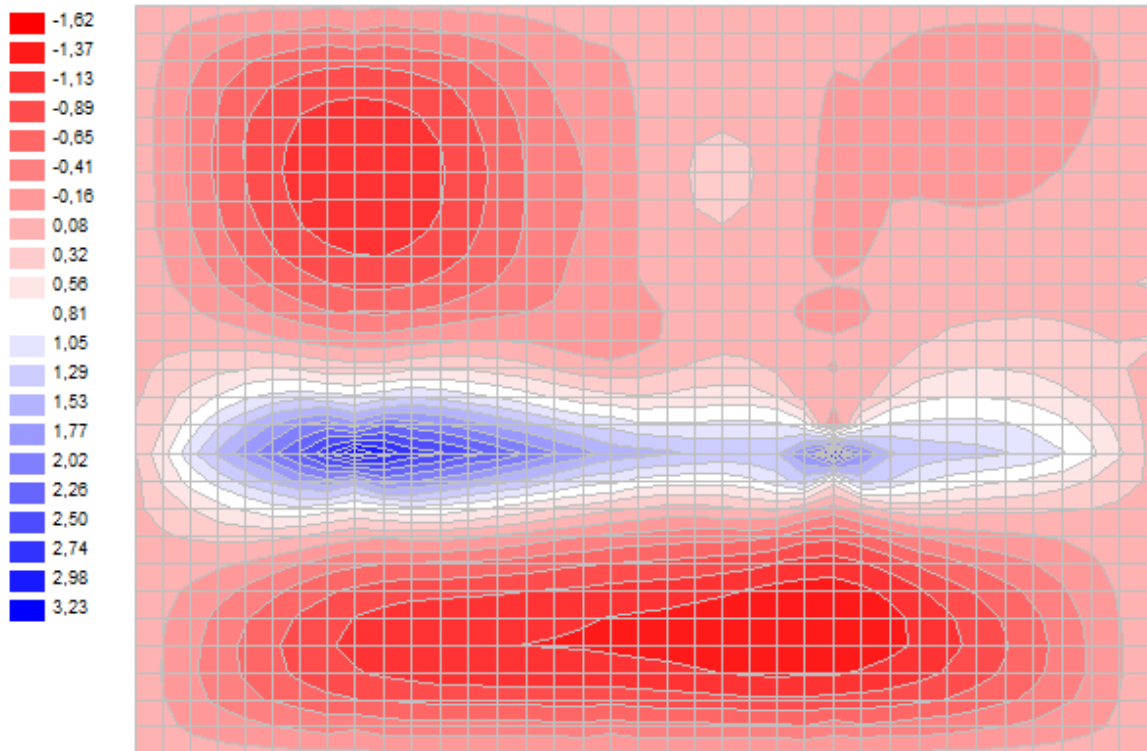

Slika 4.10. Količina potrebne armature M_y (cm^2/m')

Zbog sigurnosti proračunali smo i grafičku armaturnu kombinaciju. Proračuni pokrivaju istu vrijednost pa ostajemo pri odabranoj armaturi.

ODABRANO: **R-335** ($A_s = 3,35 \text{ cm}^2/\text{m}$) + preklop 40 cm

Minimalna armatura:

$$A_{s1, \min} \geq 0,26 \cdot [f_{ct,m} / f_{yk}] \cdot b_t \cdot d \geq 0,0013 \cdot b_t \cdot d$$

b_t – širina vlačne zone

d – statička visina presjeka

f_{yk} – karakt. granica popuštanja čelika u N/mm^2

[$f_{yk} = 500 \text{ N}/\text{mm}^2$ za čelik B 500B]

$f_{ct,m}$ - srednja vlačna čvrstoća betona (iz tablice)

[$f_{ct,m} = 2,9 \text{ N}/\text{mm}^2$ za C 30/37]

$$A_{s1, \min} \geq 0,26 \cdot 2,9 / 500 \cdot 100 \cdot 14,0 = 2,11 \text{ cm}^2 / \text{m}$$

$$A_{s1, \min} \geq 0,0013 \cdot b_t \cdot d = 0,0013 \cdot 100 \cdot 14,0 = 1,82 \text{ cm}^2 / \text{m}$$

5. PRORAČUN PLOČE POZICIJE 100

5.1. MOMENTI SAVIJANJA U PLOČI POZICIJE 100

5.1.1 Vlastita težina

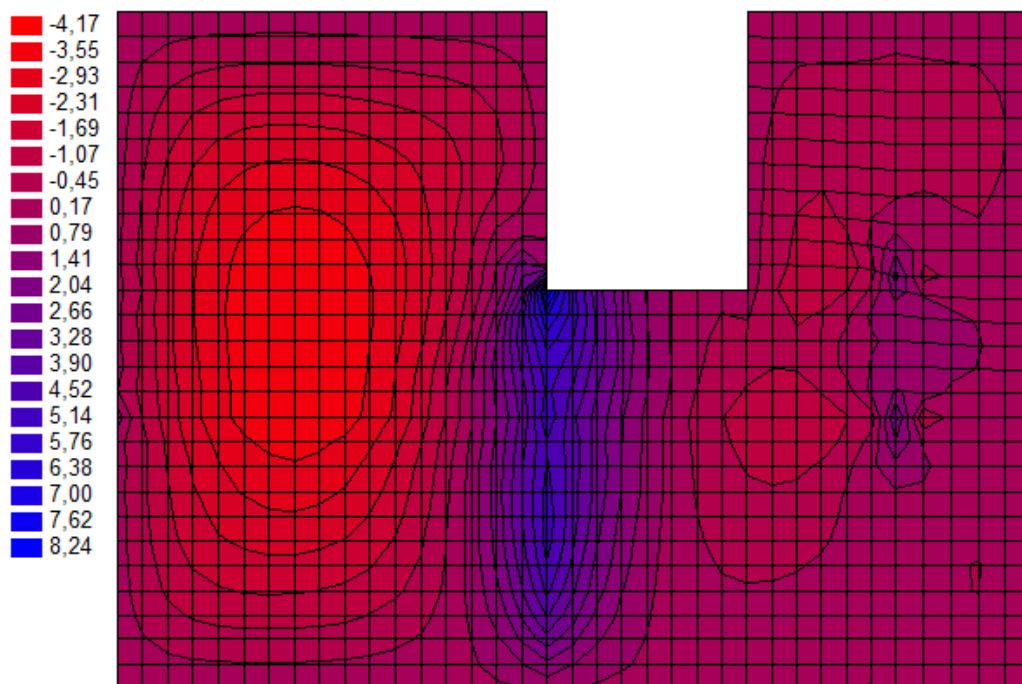

Slika 5.1. Momenti M_x (kNm)

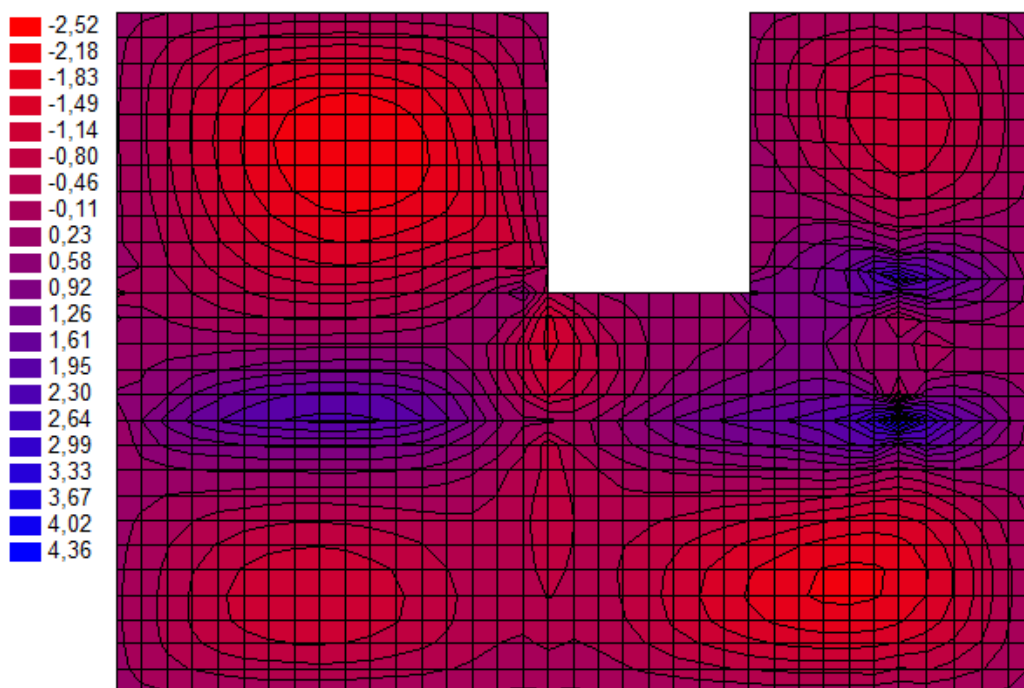

Slika 5.2. Momenti M_y (kNm)

5.1.2. Dodatno stalno opterećenje

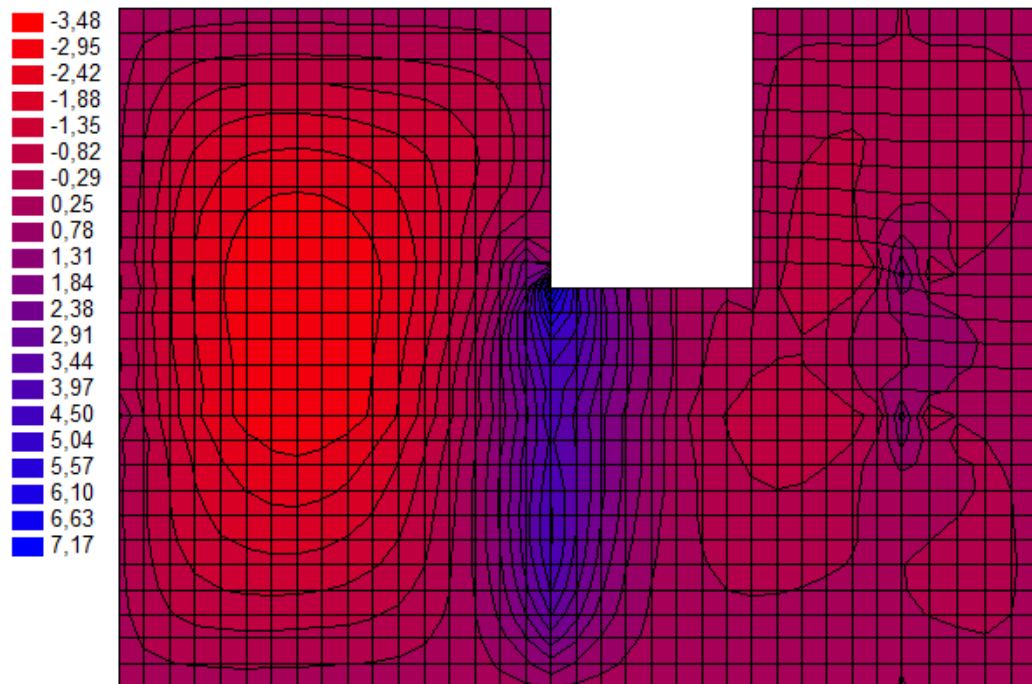

Slika 5.3. Momenti M_x (kNm)

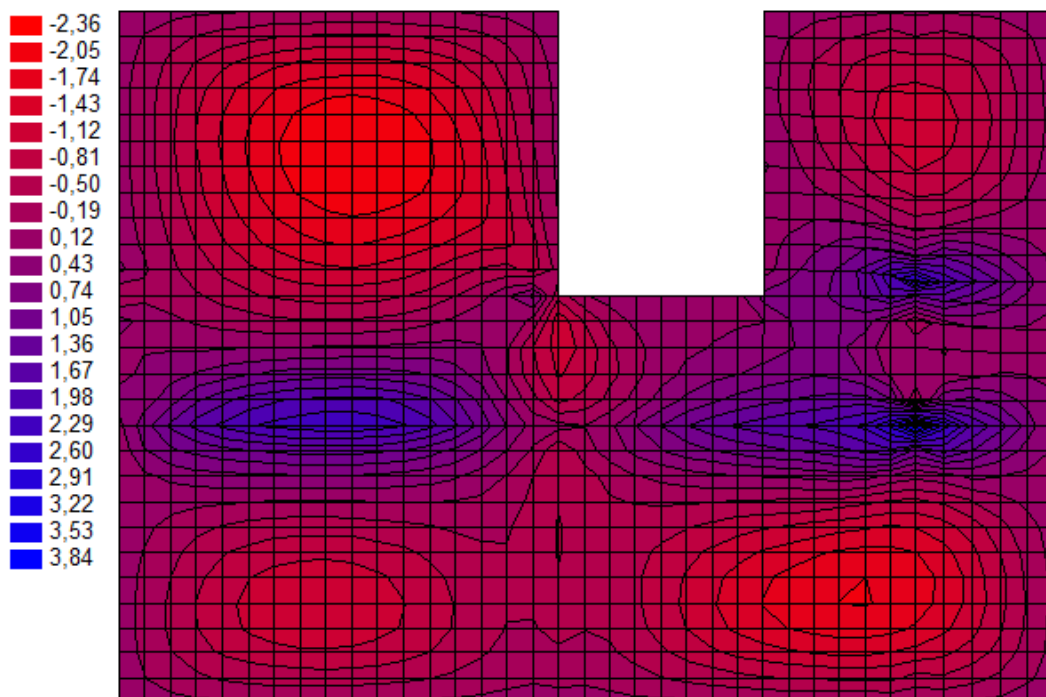

Slika 5.4. Momenti M_y (kNm)

5.1.3. Uporabno opterečenje

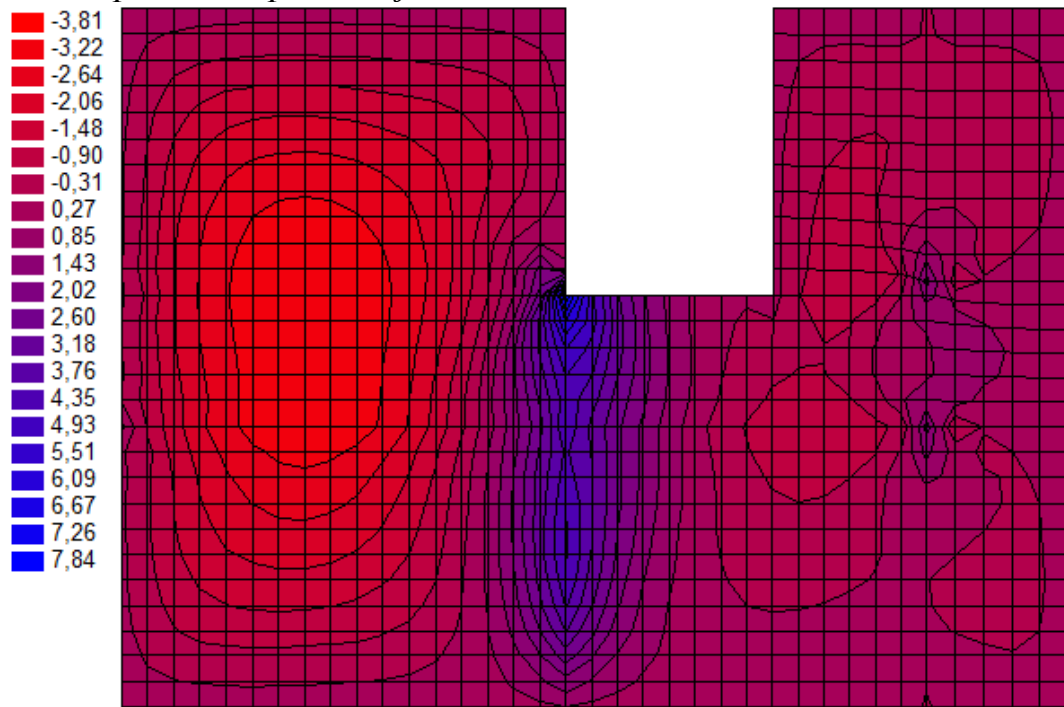

Slika 5.5. Momenti M_x (kNm)

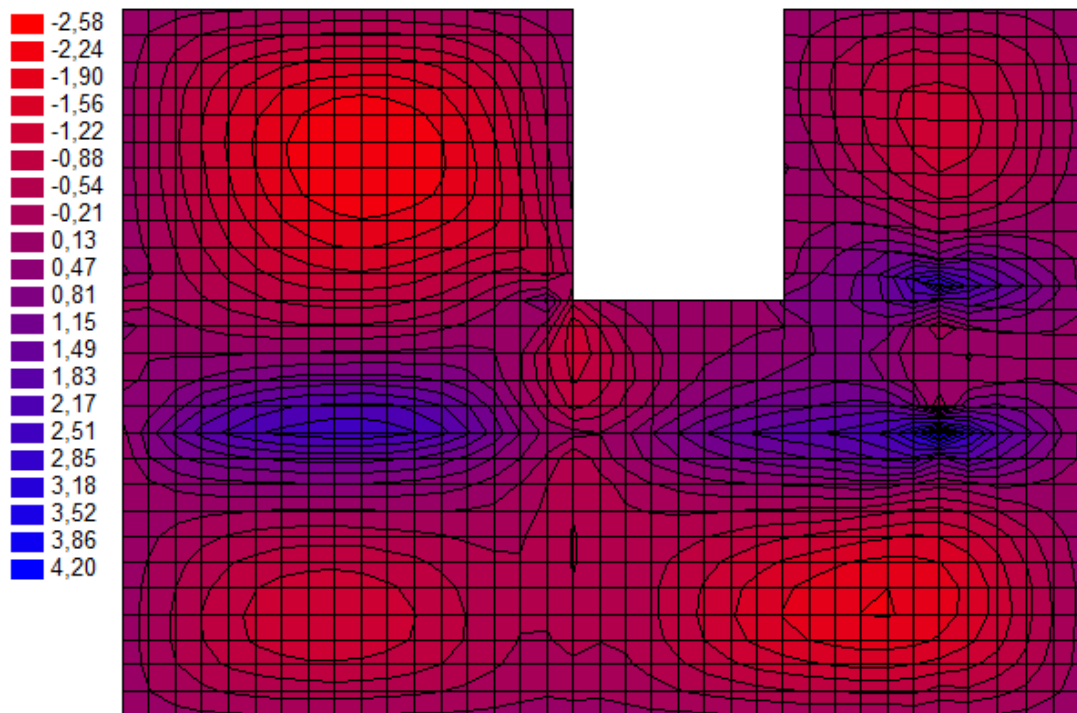

Slika 5.6. Momenti M_y (kNm)

5.1.4. Granično stanje nosivosti

Mjerodavna kombinacija: $M_{sd}=1,35*(M_g+M_{\Delta g})+1,5*M_q$

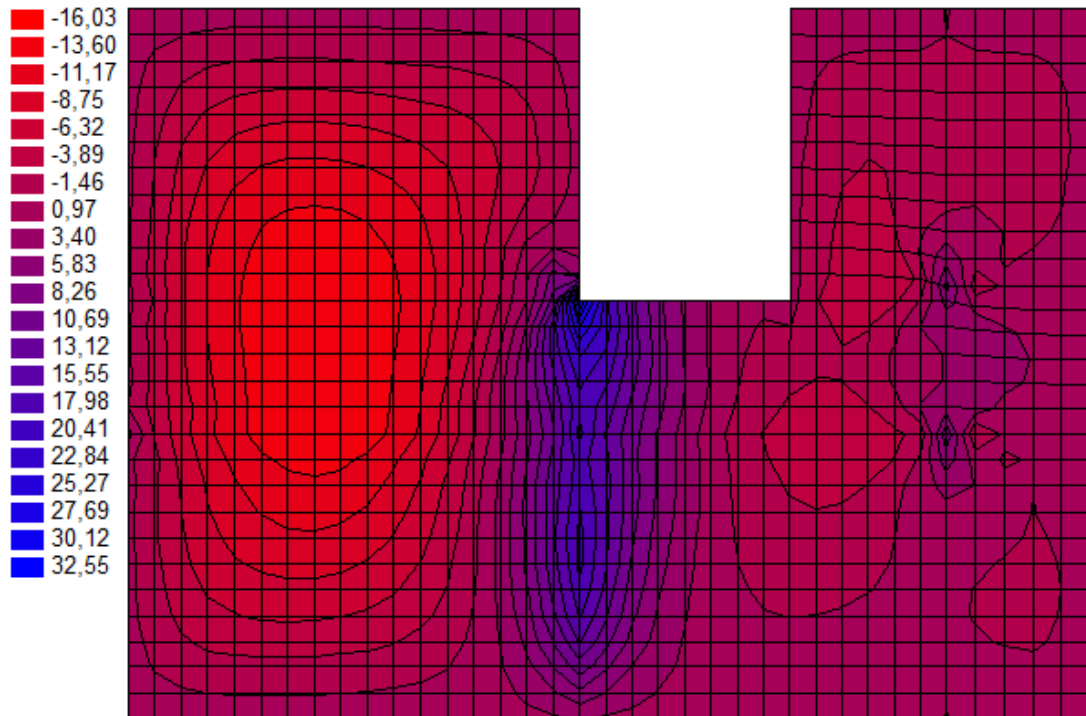

Slika 5.7. Momenti M_x (kNm)

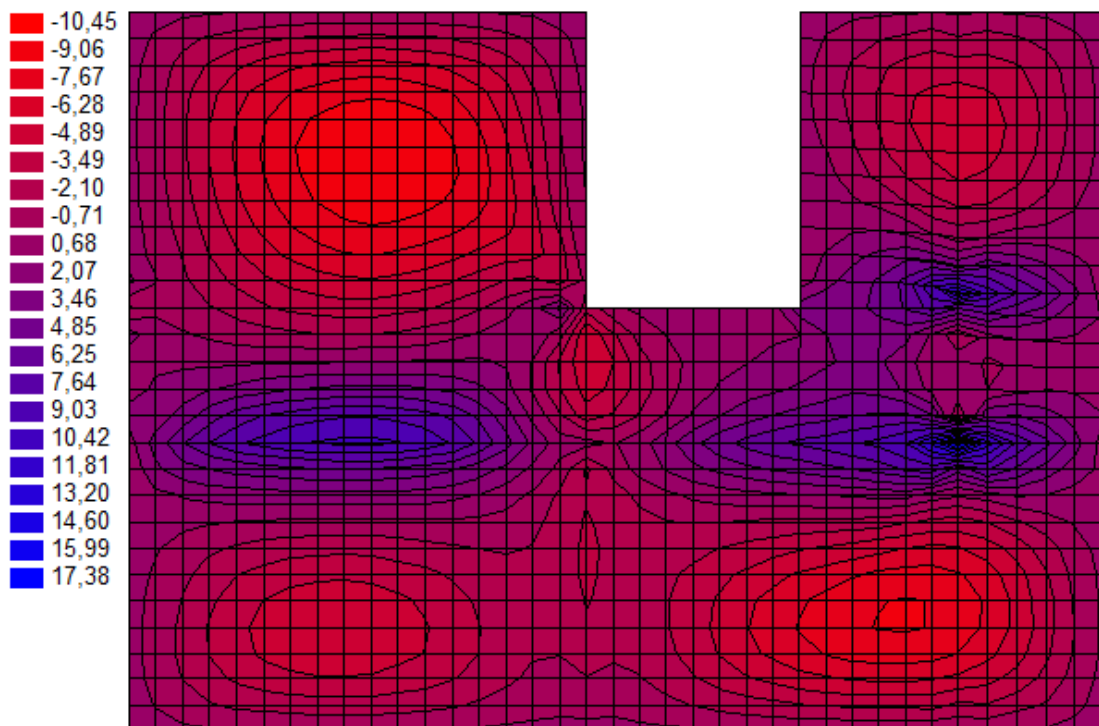

Slika 5.8. Momenti M_y (kNm)

5.2. DIMENZIONIRANJE PLOČE POZICIJE 100

BETON: C 30/37;

$$f_{ck} = 30,0 \text{ MPa} = 30,0 \text{ N/mm}^2; \gamma_c = 1,5$$

$$f_{cd} = f_{ck} / \gamma_c = 20,0 \text{ N/mm}^2 = 2,0 \text{ kN/cm}^2$$

ARMATURA: B 500 B;

$$f_{yk} = 500,0 \text{ MPa} = 500 \text{ N/mm}^2; \gamma_s = 1,15$$

$$f_{yd} = f_{yk} / \gamma_s = 500,0 / 1,15 = 434,78 \text{ MPa} = 434,78 \text{ N/mm}^2 = 43,48 \text{ kN/cm}^2$$

Ploča – polje

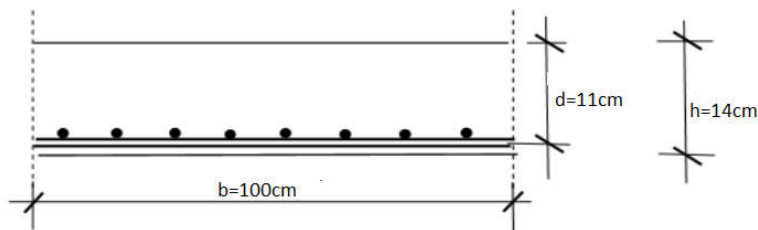

$$M_{Ed} = 16,03 \text{ kNm/m}$$

$$\mu_{sd} = M_{Ed} / b * d^2 * f_{cd} = 1603 / 100 * 14^2 * 2,0 = 0,041$$

$$\text{Očitano: } \epsilon_{s1} = 10,0 \text{ ‰} \quad \epsilon_{c2} = 1,2 \text{ ‰} \quad \zeta = 0,962 \quad \xi = 0,107$$

$$A_{s1} = M_{Ed} / \zeta * d * f_{yd} = 1603 / 0,962 * 14 * 43,48 = 2,74 \text{ cm}^2/\text{m}$$

Odabrano za sve ploče: Q-283 ($A_s = 2,83 \text{ cm}^2/\text{m}$)

Ploča - Ležaj

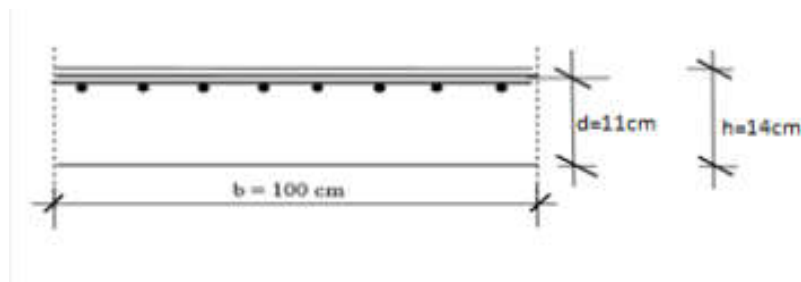

$$M_{Ed} = 32,55 \text{ kNm/m}$$

$$\mu_{sd} = M_{Ed} / b * d^2 * f_{cd} = 3255 / 100 * 14^2 * 2,0 = 0,083$$

$$\text{Očitano: } \epsilon_{s1} = 10,0 \text{ ‰} \quad \epsilon_{c2} = 1,9 \text{ ‰} \quad \zeta = 0,941 \quad \xi = 0,160$$

$$A_{s1} = M_{Ed} / \zeta * d * f_{yd} = 3255 / 0,941 * 14 * 43,48 = 5,68 \text{ cm}^2/\text{m}$$

Odabrana mreža: R-636 ($A_s = 6,36 \text{ cm}^2/\text{m}$)

koef. za stalno opterećenje: $1,35 * 0,167 = 0,225$

koef. za promjenjivo opterećenje : $1,5 * 0,167 = 0,25$

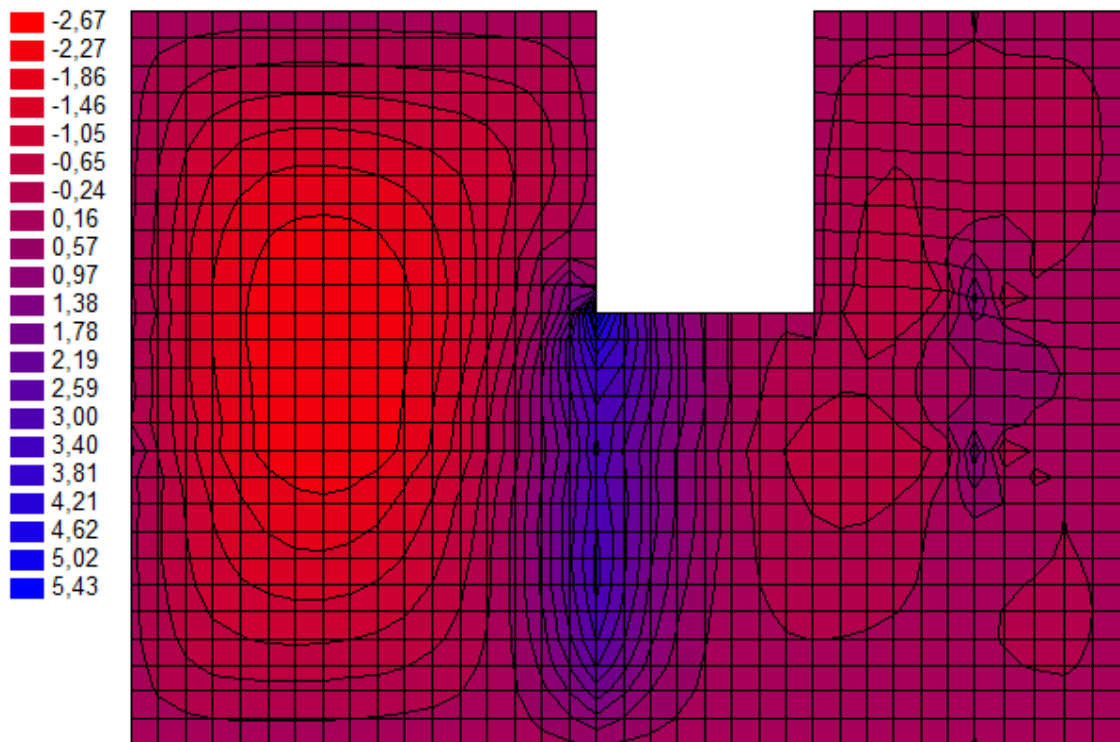

Slika 5.9. Količina potrebne armature M_y (cm^2/m)

Zbog sigurnosti proračunali smo i grafičku armaturnu kombinaciju. Proračuni pokazuju istu vrijednost pa ostajemo pri odabranoj armaturi.

ODABRANO: R- 636 ($A_s = 6,36 \text{ cm}^2$) + preklop 40 cm

Minimalna armatura:

$$A_{s1, \min} \geq 0,26 \cdot [f_{ct,m} / f_{yk}] \cdot b_t \cdot d \geq 0,0013 \cdot b_t \cdot d$$

b_t – širina vlačne zone

d – statička visina presjeka

f_{yk} – karakt. granica popuštanja čelika u N/mm^2

[$f_{yk} = 500 \text{ N}/\text{mm}^2$ za čelik B 500B]

$f_{ct,m}$ - srednja vlačna čvrstoća betona (iz tablice)

[$f_{ct,m} = 2,9 \text{ N}/\text{mm}^2$ za C 30/37]

$$A_{s1, \min} \geq 0,26 \cdot 2,9 / 500 \cdot 100 \cdot 14,0 = 2,11 \text{ cm}^2 / \text{m}$$

$$A_{s1, \min} \geq 0,0013 \cdot b_t \cdot d = 0,0013 \cdot 100 \cdot 14,0 = 1,82 \text{ cm}^2 / \text{m}$$

6. PRORAČUN KONTINUIRANOG NOSAČA POZICIJE 100

6.1. MOMENTI SAVIJANJA I POPREČNE SILE GREDE POZICIJE 100

6.1.1. Vlastita težina

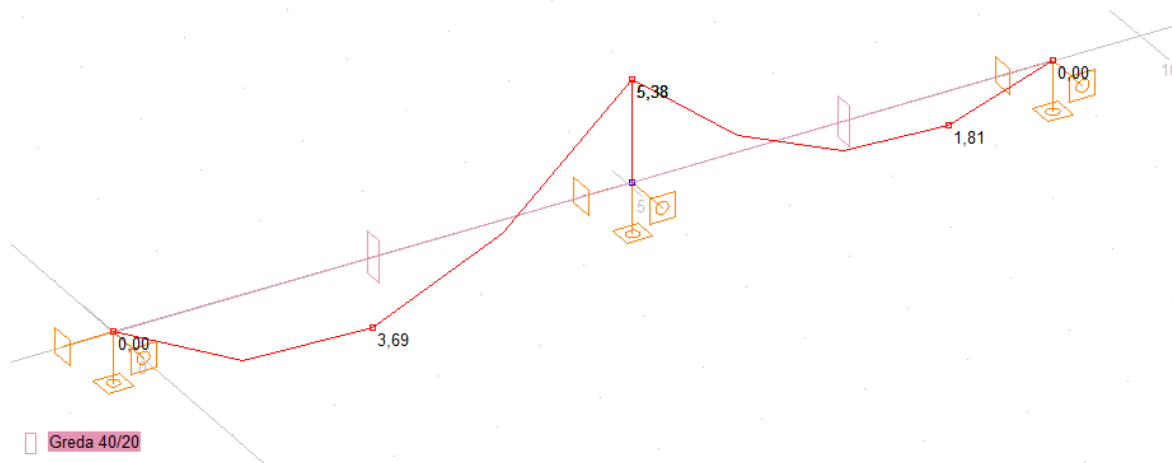

Slika 6.1. Momenti M_z (kNm)

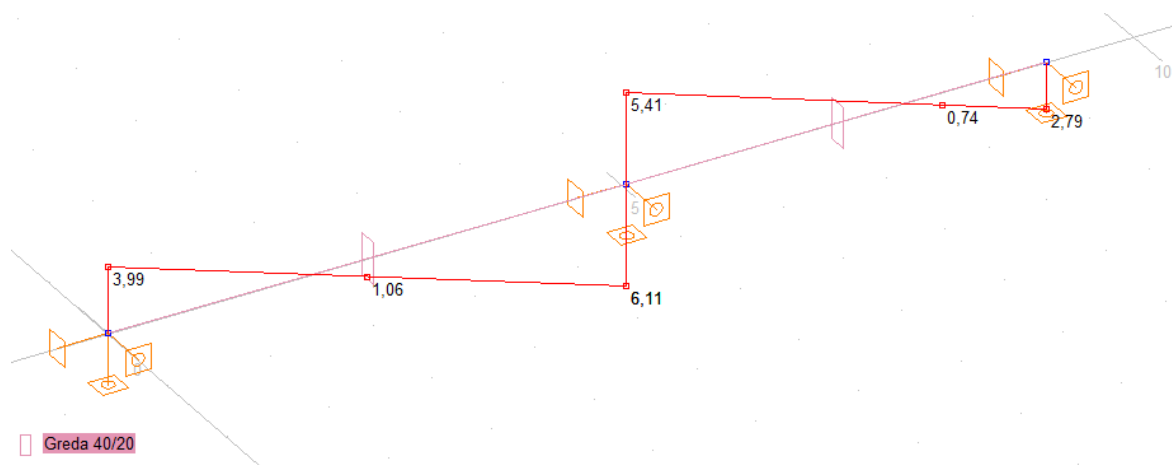

Slika 6.2. Poprečne sile T_y (kN)

6.1.2. Dodatno stalno opterećenje

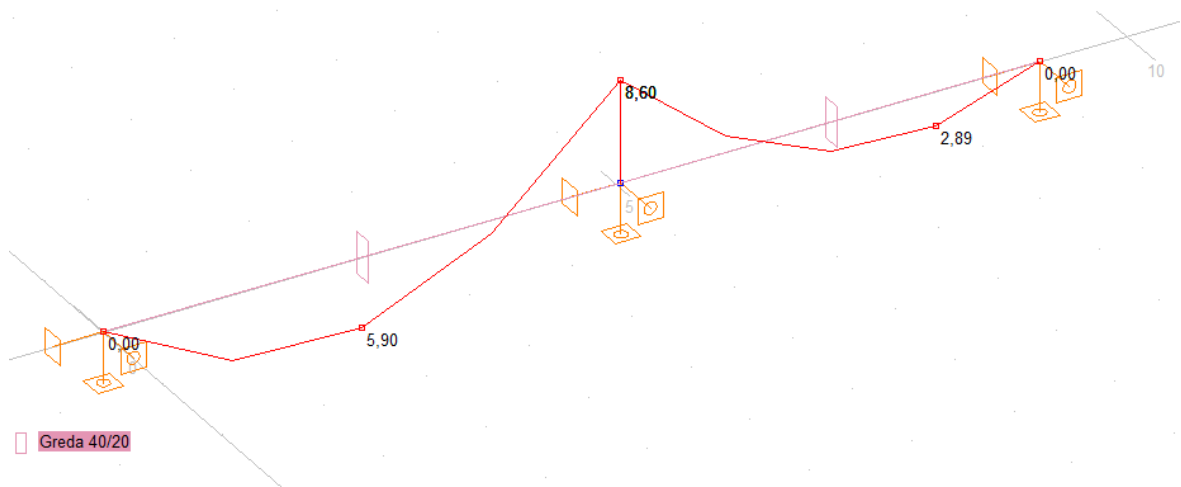

Slika 6.3. Momenti M_z (kNm)

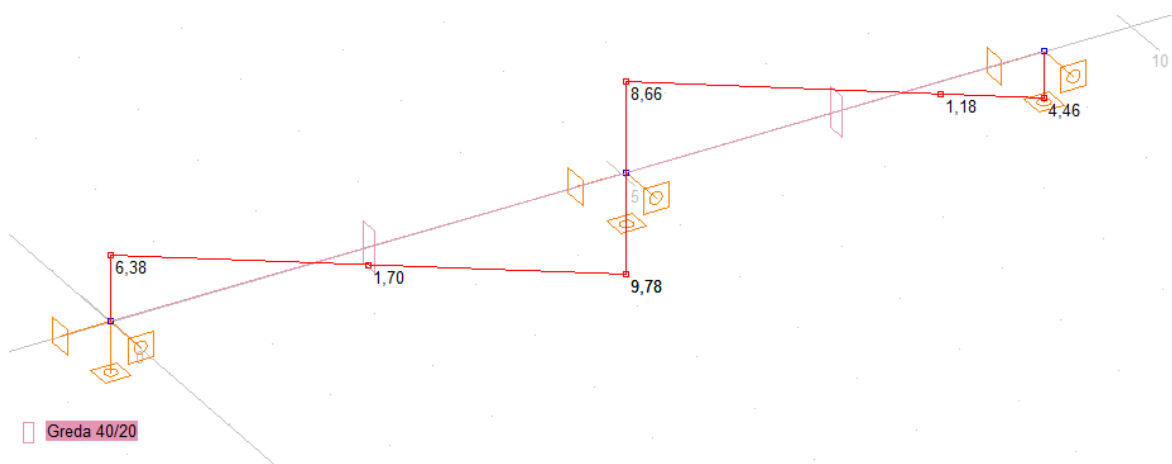

Slika 6.4. Poprečne sile T_y (kN)

6.1.3. Uporabno opterečenje

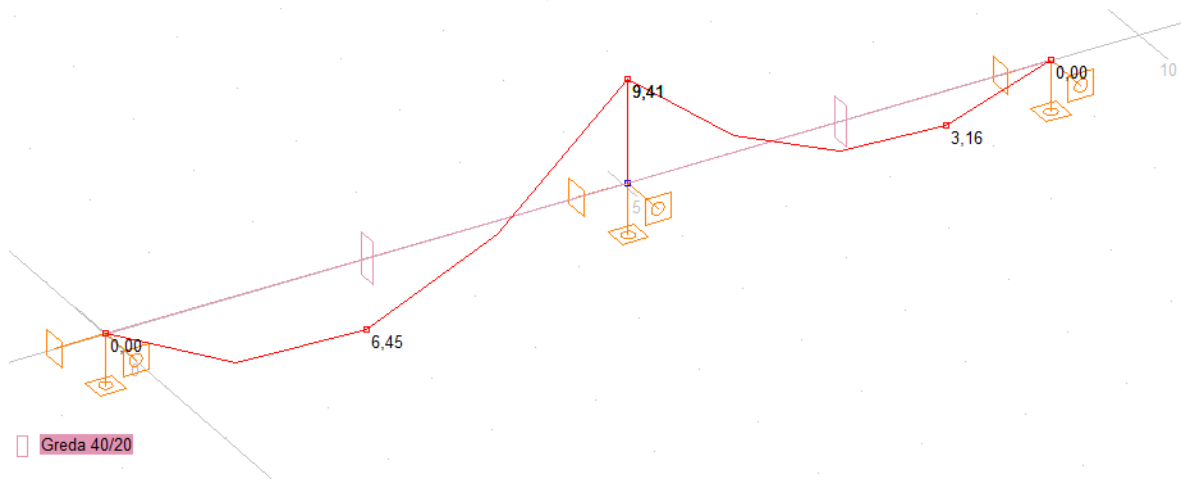

Slika 6.5. Momenti M_z (kNm)

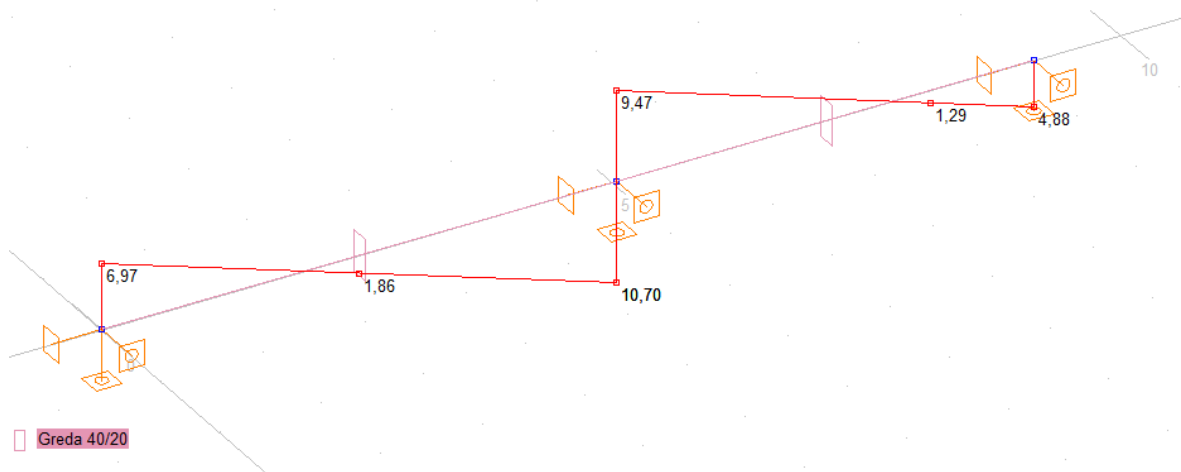

Slika 6.6. Poprečne sile T_y (kN)

6.1.4. Granično stanje nosivosti

Mjerodavna kombinacija za proračun GSN: $M_{sd} = 1,35 \cdot (M_g + M_{\Delta g}) + 1,5 \cdot M_q$

Momenti:

$$M_{Ed, polje1} = 22,62 \text{ kNm}$$

$$M_{Ed, ležaj} = -32,99 \text{ kNm}$$

$$M_{Ed, polje2} = 11,09 \text{ kNm}$$

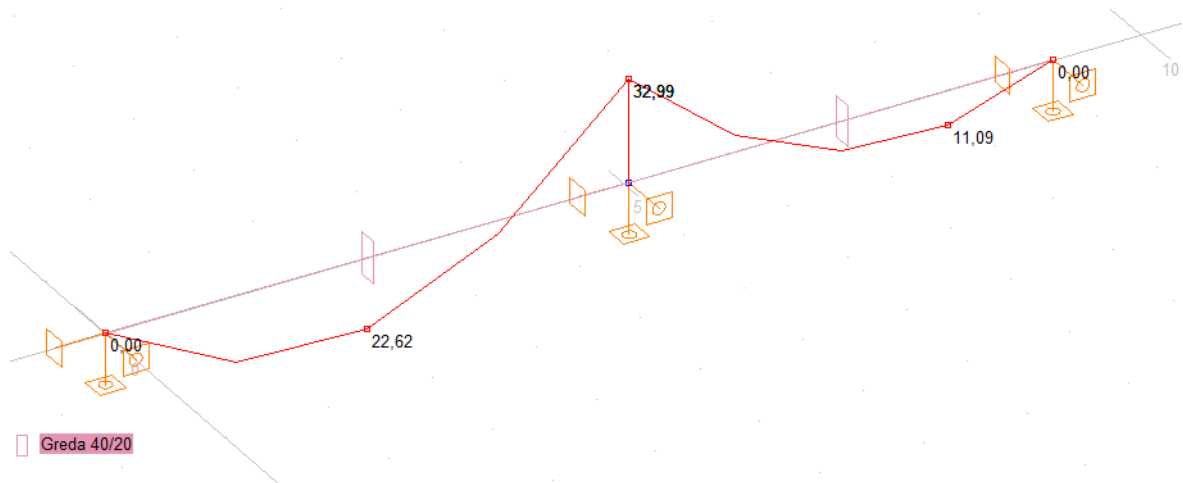

Slika 6.7. Momenti M_z (kNm)

Poprečne sile:

$$V_{Ed, ležaj1} = 37,51 \text{ kN}$$

$$V_{Ed, ležaj0} = 24,45 \text{ kN}$$

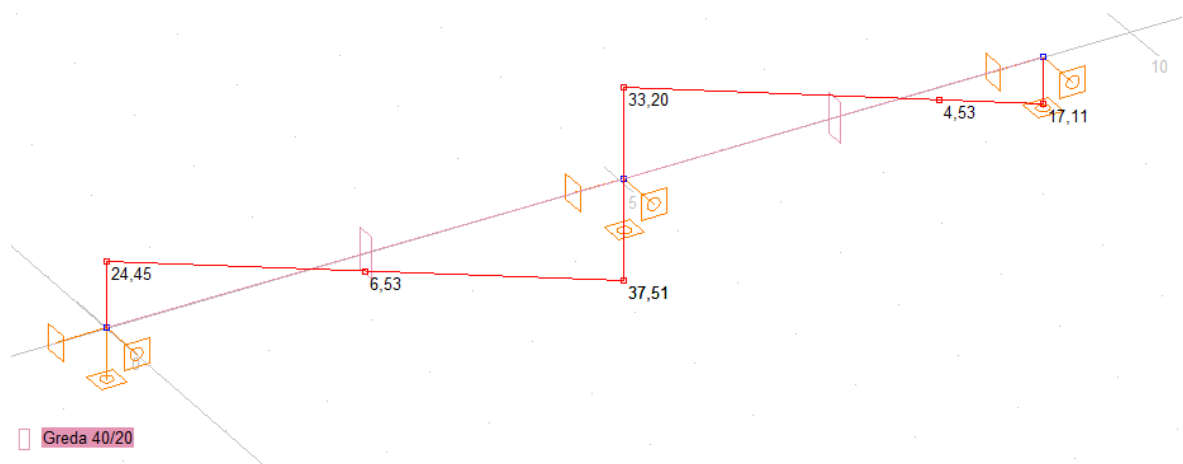

Slika 6.8. Poprečne sile T_y (kN)

6.2.DIMENZIONIRANJE NA MOMENT SAVIJANJA

BETON: C 30/37;

$$f_{ck} = 30,0 \text{ MPa} = 30,0 \text{ N/mm}^2; \gamma_c = 1,5$$

$$f_{cd} = f_{ck} / \gamma_c = 20,0 \text{ N/mm}^2 = 2,0 \text{ kN/cm}^2$$

ARMATURA: B 500 B;

$$f_{yk} = 500,0 \text{ MPa} = 500 \text{ N/mm}^2; \gamma_s = 1,15$$

$$f_{yd} = f_{yk} / \gamma_s = 500,0 / 1,15 = 434,78 \text{ MPa} = 434,78 \text{ N/mm}^2 = 43,48 \text{ kN/cm}^2$$

Polje:

Utjecajna širina: $b_{\text{eff}} = b_o + l_o / 5 = 20 + 0,85 \cdot 505 / 5 = 105,9$

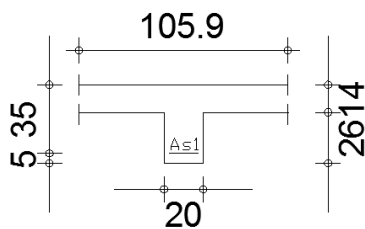

$$M_{Ed} = 22,62 \text{ kNm}$$

$$\mu_{sd} = \frac{M_{Ed}}{b_{\text{eff}} \cdot d^2 \cdot f_{cd}} = \frac{22,62}{105,9 \cdot 35^2 \cdot 2,0} = 0,009$$

Očitano: $\varepsilon_{s1} = 10,0 \text{ ‰}$ $\varepsilon_{c2} = 0,5 \text{ ‰}$ $\xi = 0,048$ $\zeta = 0,964$

$$x = \xi \cdot d = 0,048 \cdot 35 = 1,68 \text{ cm} < h_{pl} = 14 \text{ cm}$$

$$A_{s1} = \frac{M_{Ed}}{\zeta \cdot d \cdot f_{yd}} = \frac{2262}{0,964 \cdot 35 \cdot 43,48} = 1,54 \text{ cm}^2$$

$$d_1 = 5 \text{ cm}$$

$$d = h - d_1 = 40 - 5 = 35 \text{ cm}$$

Odabrano 2Ø10 ($A_s = 1,57 \text{ cm}^2$)

Ležaj 1:

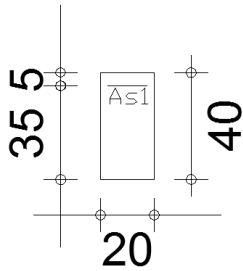

$$M_{Ed} = 32,99 \text{ kNm}$$

$$\mu_{sd} = \frac{M_{Ed}}{b_w \cdot d^2 \cdot f_{cd}} = \frac{3299}{20 \cdot 35^2 \cdot 2.0} = 0,067$$

$$\text{Očitano: } \varepsilon_{s1} = 10,0 \text{ ‰} \quad \varepsilon_{c2} = 1,7 \text{ ‰} \quad \xi = 0,145 \quad \zeta = 0,947$$

$$x = \xi \cdot d = 0,145 \cdot 35 = 5,075 \text{ cm}$$

$$A_{s1} = \frac{M_{Ed}}{\zeta \cdot d \cdot f_{yd}} = \frac{3299}{0,947 \cdot 35 \cdot 43,48} = 2,29 \text{ cm}^2$$

$$d_1 = 5 \text{ cm}$$

$$d = h - d_1 = 40 - 5 = 35 \text{ cm}$$

Oabrano 3Ø10 ($A_s = 2,36 \text{ cm}^2$)

Minimalna armatura:

$$A_{s1, \min} \geq 0,26 \cdot [f_{ct,m} / f_{yk}] \cdot b \cdot t \cdot d \geq 0,0013 \cdot b \cdot t \cdot d$$

b t – širina vlačne zone

d – statička visina presjeka

f_{yk} – karakt. granica popuštanja čelika u N/mm²

$$[f_{yk} = 500 \text{ N/mm}^2 \text{ za čelik B 500B}]$$

f_{ct,m} - srednja vlačna čvrstoća betona (iz tablice)

$$[f_{ctm} = 2,9 \text{ N/mm}^2 \text{ za C 30/37}]$$

$$A_{s1, \min} \geq 0,26 \cdot 2,9 / 500 \cdot 20 \cdot 35 = 1,056 \text{ cm}^2$$

$$A_{s1, \min} \geq 0,0013 \cdot b \cdot t \cdot d = 0,0013 \cdot 20 \cdot 35 = 0,91 \text{ cm}^2$$

Maksimalna armatura:

$$A_{s1, \max} = 0,04 \cdot A_c = 0,04 \cdot 20 \cdot 40 = 32$$

6.3.DIMENZIONIRANJE NA POPREČNU SILU

Ležaj 1

C 30/37

$$V_{Ed} = 37,51 \text{ kN}$$

$$N_{Ed} = 0.0 \text{ kN}$$

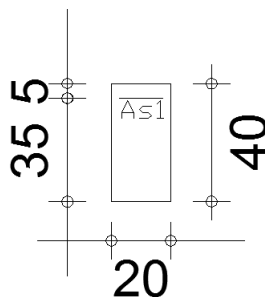

$$A_{s1} = 3\phi 10 = 2,36 \text{ cm}^2$$

$$V_{Rdc} = \left[C_{Rdc} \cdot k \cdot (100 \cdot \rho_l \cdot f_{ck})^{\frac{1}{3}} + k_1 \cdot \sigma_{cp} \right] \cdot b_w \cdot d$$

$$b_w = 20 \text{ cm} \quad ; \quad d = 35 \text{ cm}$$

$$k = 1 + \sqrt{\frac{200}{d}} = 1 + \sqrt{\frac{200}{350}} = 1.76 \leq 2$$

$$k_1 = 0.15$$

$$\sigma_{cp} = \frac{N_{sd}}{A_c} = 0.0$$

$$\Sigma A_s = 4\phi 10 = 3,14 \text{ cm}^2$$

$$\rho_l = \frac{\Sigma A_s}{A_c} = \frac{3\phi 10}{20 \cdot 35} = \frac{2,36}{700} = 0,0034$$

$$C_{Rdc} = \frac{0.18}{\gamma_c} = \frac{0.18}{1.5} = 0.12$$

$$V_{Rdc} = \left[0.12 \cdot 1.76 \cdot (100 \cdot 0.0034 \cdot 30)^{\frac{1}{3}} \right] \cdot 200 \cdot 350 = 32,06 \text{ kN}$$

$$V_{Rdc} \geq [v_{\min} + k_1 \cdot \sigma_{cp}] \cdot b_w \cdot d$$

$$v_{\min} = 0.035 \cdot k^{\frac{3}{2}} \cdot f_{ck}^{\frac{1}{2}} = 0.035 \cdot 1.76^{\frac{3}{2}} \cdot 30^{\frac{1}{2}} = 0.448$$

$$\sigma_{cp} = \frac{N_{sd}}{A_c} = 0.0$$

$$V_{Rdc} \geq v_{\min} \cdot b_w \cdot d = 0.448 \cdot 200 \cdot 350 = 31,36 \text{ kN} \leq V_{Ed}$$

$$V_{Ed, \max} = V_{Ed} = 37,51 \text{ kN}$$

$$V_{Rd, \max} = 0.5 \cdot v \cdot b_w \cdot d \cdot f_{cd}$$

$$v = 0.6 \cdot \left[1 - \frac{f_{ck}}{250} \right] = 0.6 \cdot \left[1 - \frac{30}{250} \right] = 0.528$$

$$V_{Rd, \max} = 0.5 \cdot 0.528 \cdot 200 \cdot 350 \cdot 20,0 = 369,60 \text{ kN} > V_{Ed, \max} = V_{Ed}$$

$$V_{Ed, \max} / V_{Rd, \max} = 37,51 / 369,60 = 0.1014 \approx 0.10 \Rightarrow V_{Ed} = 0.10 V_{Rd, \max}$$

$$s_{\max} = \min\{0.75 \cdot d; 30\} = \min\{26,25; 30\} \Rightarrow s_{\max} = 30.0 \text{ cm}$$

$$\rho_{\min} = 0,0011$$

Površina minimalne armature:

$$A_{s_{w,\min}} = \frac{\rho_{\min} \cdot s_w \cdot b_w}{m} = \frac{0.0011 \cdot 30 \cdot 20}{2} = 0.33 \text{ cm}^2$$

Odabrane minimalne spone: **Ø7/30** ($A_{s_w}=0.38 \text{ cm}^2$)

$$f_{yw,d} = \frac{f_{yk}}{\gamma_s}; B500B \Rightarrow f_{ywd} = \frac{500}{1.15} = 434.8 \text{ MPa} = 43.48 \text{ kN / cm}^2$$

$$V_{Rd} = V_{Rd,s} = \frac{A_{s_w}}{s} \cdot z \cdot f_{ywd} \cdot m \cdot \text{ctg}\theta = \frac{0.38}{30} \cdot (0.9 \cdot 35) \cdot 43.48 \cdot 2 \cdot 1$$

$$V_{Rd} = 34,69 \text{ kN}$$

$$V_{Ed} > V_{Rd}$$

Na mjestu maksimalne poprečne sile:

$$s_w \leq \frac{m \cdot A_{s_w} \cdot f_{yw,d} \cdot z}{V_{Ed}} = \frac{2 \cdot 0.38 \cdot 43.48 \cdot 0.9 \cdot 35}{37,51} = 13,88 \text{ cm}$$

Postaviti spone **Ø7/12** ($A_{s_w}=0.38 \text{ cm}^2$)

6.4.KONTROLA PUKOTINA GREDE POZICIJE 100

Granično stanje uporabljivosti: 1.0 vlastita težina "+" 1.0 dodatno stalno "+" 1.0 korisno

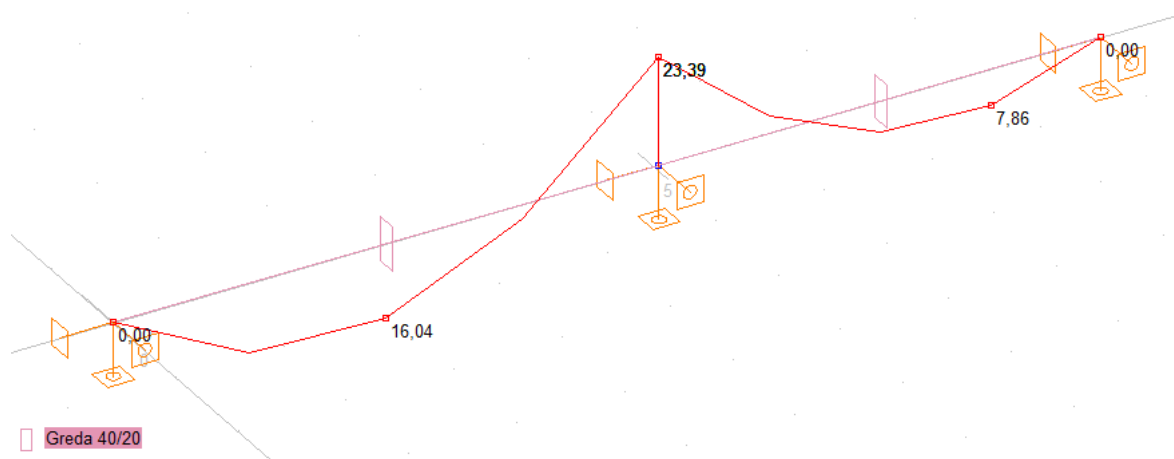

Slika6.9.Moment (kNm)

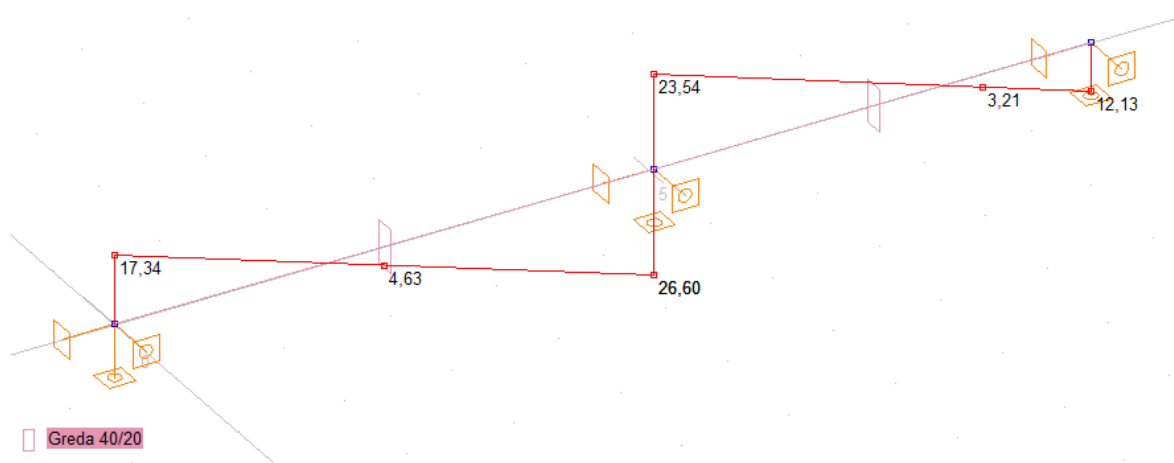

Slika6.10.Poprečna sila (kN)

Polje :

$$M_{Ed} = 16,04 \text{ kNm}$$

Prognoza širine pukotine:

$$w_k = s_{r,max} \cdot (\varepsilon_{s,m} - \varepsilon_{c,m})$$

Proračun srednje deformacije armature:

$$(\varepsilon_{s,m} - \varepsilon_{c,m}) = \frac{\sigma_s - k_t \cdot \frac{f_{ct,eff}}{\rho_{p,eff}} \cdot (1 + \alpha_e \cdot \rho_{p,eff})}{E_s} \approx 0.6 \cdot \frac{\sigma_s}{E_s}$$

$$A_{s1} = 2\emptyset 10 = 1,57 \text{ cm}^2$$

$$E_{cm} = 35.00 \text{ GPa} = 35000 \text{ MPa} - \text{modul elastičnosti betona}$$

$$E_s = 200.0 \text{ GPa} = 200000.0 \text{ MPa} - \text{modul elastičnosti armature}$$

$$f_{ctm} = 2.9 \text{ MPa} - \text{za betone klase C 30/37}$$

$$k_t = 0.4 - \text{dugotrajno opterećenje}$$

$$\alpha_e = \frac{E_s}{E_{cm}} = \frac{200}{35.0} = 5.71$$

$$x = \frac{\alpha_e \cdot A_{s1}}{b} \cdot \left(-1 + \sqrt{1 + \frac{2 \cdot b \cdot d}{\alpha_e \cdot A_{s1}}} \right) = \frac{5.71 \cdot 1.57}{20} \cdot \left(-1 + \sqrt{1 + \frac{2 \cdot 20 \cdot 35}{5.71 \cdot 1.57}} \right) = 5,17 \text{ cm}$$

$$\sigma_s = \frac{M_{Ed}}{z \cdot A_{s1}} \approx \frac{M_{Ed}}{\left(d - \frac{x}{3}\right) \cdot A_{s1}} = \frac{1604}{\left(35 - \frac{5,17}{3}\right) \cdot 1,57} = 30,71 \text{ kN /cm}^2 = 307,12 \text{ MPa}$$

$$\rho_{p,eff} = \frac{A_{s1}}{A_{c,eff}} = \frac{A_{s1}}{b \cdot 2.5 \cdot d_1} = \frac{1,57}{20 \cdot 2.5 \cdot 5.0} = 0.00628$$

$$(\varepsilon_{s,m} - \varepsilon_{c,m}) = \frac{307.12 - 0.4 \cdot \frac{2.9}{0.00628} \cdot (1 + 5.71 \cdot 0.00628)}{200000} \approx 0.6 \cdot \frac{307.12}{200000}$$

$$\frac{115.783}{200000} > \frac{184.272}{200000}$$

$$(\varepsilon_{s,m} - \varepsilon_{c,m}) = 0.000579$$

→ neće doći do pojave pukotina!

Ležaj:

$$M_{Ed} = 23,39 \text{ kNm}$$

Prognoza širine pukotine:

$$w_k = s_{r,max} \cdot (\varepsilon_{s,m} - \varepsilon_{c,m})$$

Proračun srednje deformacije armature:

$$(\varepsilon_{s,m} - \varepsilon_{c,m}) = \frac{\sigma_s - k_t \cdot \frac{f_{ct,eff}}{\rho_{p,eff}} \cdot (1 + \alpha_e \cdot \rho_{p,eff})}{E_s} \approx 0.6 \cdot \frac{\sigma_s}{E_s}$$

$$A_{s1} = 3\emptyset 10 = 2,36 \text{ cm}^2$$

$$E_{cm} = 35.00 \text{ GPa} = 35000 \text{ MPa} - \text{modul elastičnosti betona}$$

$$E_s = 200.0 \text{ GPa} = 200000.0 \text{ MPa} - \text{modul elastičnosti armature}$$

$$f_{ctm} = 2,9 \text{ MPa} - \text{za betone klase C 30/37}$$

$$k_t = 0.4 - \text{dugotrajno opterećenje}$$

$$\alpha_e = \frac{E_s}{E_{cm}} = \frac{200}{35.0} = 5.71$$

$$x = \frac{\sigma_s \cdot A_{s1}}{b} \cdot \left(-1 + \sqrt{1 + \frac{2 \cdot b \cdot d}{\sigma_s \cdot A_{s1}}} \right) = \frac{5.71 \cdot 2.36}{20} \cdot \left(-1 + \sqrt{1 + \frac{2 \cdot 20 \cdot 35}{5.71 \cdot 2.36}} \right) = 6,23 \text{ cm}$$

$$\sigma_s = \frac{M_{Ed}}{z \cdot A_{s1}} \approx \frac{M_{Ed}}{\left(d - \frac{x}{3}\right) \cdot A_{s1}} = \frac{2339}{\left(35 - \frac{6,23}{3}\right) \cdot 2,36} = 30,10 \text{ kN/cm}^2 = 301,03 \text{ MPa}$$

$$\rho_{p,eff} = \frac{A_{s1}}{A_{o,eff}} = \frac{A_{s1}}{b \cdot 2.5 \cdot d_1} = \frac{2.36}{20 \cdot 2.5 \cdot 5.0} = 0.00944$$

$$(\varepsilon_{s,m} - \varepsilon_{c,m}) = \frac{301.03 - 0.4 \cdot \frac{2.9}{0.00944} \cdot (1 + 5.71 \cdot 0.00944)}{200000} \approx 0.6 \cdot \frac{301.03}{200000}$$

$$\frac{171.53}{200000} > \frac{180.618}{200000}$$

$$(\varepsilon_{s,m} - \varepsilon_{c,m}) = 0.000859$$

→ neće doći do pojave pukotina!

6.5.KONTROLA PROGIBA GREDE POZICIJE 100

Progib kontroliramo za nefaktorizirano opterećenje i bez utjecaja puzanja.

Kontrola progiba za Polje :

Granični progib:

$$v_{\text{lim}} = \frac{L}{250} = \frac{505}{250} = 2.02 \text{ cm}$$

Beton: C 30/37; $f_{ck}=30.0 \text{ MPa}$

$$E_{cm} = 35000 \text{ MPa}$$

$$f_{ctm} = 0.3 \cdot (f_{ck})^{2/3} = 0.3 \cdot (30.0)^{2/3} = 2.9 \text{ MPa}$$

Čelik: B500B ; $E_s= 200.0 \text{ GPa}$

$$\alpha_{el} = \frac{E_s}{E_{cm}} = \frac{200.0}{35} = 5.71$$

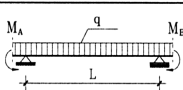
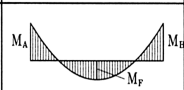
Red	Tip opterećenja	Dijagram momenata savijanja	Koeficijent k iz izraza (5.131)
7			$k = \frac{5}{48}(1 - 0.1\beta)$ $\beta = M_A + M_B / M_F $

$$v_{\text{tot}} = k \cdot L^2 \cdot \frac{1}{r_{\text{tot}}}$$

$$\beta = |M_A + M_B|/|M_F| = |0.0 + 23.39|/|16.04| = 1.458$$

$$k = \frac{5}{48} \cdot (1 - 0.1 \cdot \beta) = 0.104 \cdot (1 - 0.1 \cdot 1.1458) = 0.0888$$

Progib homogenog presjeka:

$$A_{s1} = 2\varnothing 10 = 1,57 \text{ cm}^2$$

$$A_{s2} = 3\varnothing 10 = 2,36 \text{ cm}^2$$

$$\begin{aligned} I_I &= \frac{bh^3}{12} + \alpha_{el} \cdot \left[A_{s1} \cdot \left(\frac{h}{2} - d_2 \right)^2 + A_{s2} \cdot \left(\frac{h}{2} - d_1 \right)^2 \right] \\ &= \frac{20 \cdot 40^3}{12} + 5,71 \cdot \left[1,57 \cdot \left(\frac{40}{2} - 5 \right)^2 + 2,36 \cdot \left(\frac{40}{2} - 5 \right)^2 \right] = \\ &= 111715,73 \text{ cm}^4 \end{aligned}$$

$$E_{c,eff} = E_{cm} = 35,0 \text{ GN/m}^2 = 3500,0 \text{ kN/cm}^2$$

$$\frac{1}{r_I} = \frac{M_{Ed}}{E_{c,eff} \cdot I_I} = \frac{1604}{3500 \cdot 111715,73} = 0,0000041 \frac{1}{\text{cm}}$$

Progib potpuno raspucanog presjeka:

$$x = 5,17 \text{ cm}$$

$$\begin{aligned} I_{II} &= \frac{bx^3}{12} + bx \cdot \left(\frac{x}{2} \right)^2 + \alpha_{el} \cdot \left[A_{s1} \cdot (d - x)^2 + A_{s2} \cdot (x - d_2)^2 \right] \\ &= \frac{20 \cdot 5,17^3}{12} + (20 \cdot 5,17) \cdot \left(\frac{5,17}{2} \right)^2 + 5,71 \cdot \left[1,57 \cdot (35 - 5,17)^2 + 2,36 \cdot (5,17 - 5)^2 \right] \\ &= 8898,69 \text{ cm}^4 \end{aligned}$$

$$\frac{1}{r_{II}} = \frac{M_{Ed}}{E_{c,eff} \cdot I_{II}} = \frac{1604}{3500 \cdot 8898,69} = 0,0000515 \frac{1}{\text{cm}}$$

Ukupni progib:

$$\sigma_s = 307,12 \text{ MPa}$$

$$\sigma_{sr} = \frac{M_{cr}}{\left(d - \frac{x}{3} \right) \cdot A_{s1}}$$

$$M_{cr} = f_{ctm} \cdot W = f_{ctm} \cdot \frac{b \cdot h^2}{6} = 3,5 \cdot \frac{20 \cdot 40^2}{6} = 18666,67$$

$$\sigma_{sr} = \frac{18666,67}{\left(35 - \frac{5,17}{3} \right) \cdot 5,17} = 108,50 \text{ MPa}$$

$\beta_1 = 1.0$ - Rebrasta armatura

$\beta_2 = 0.5$ - Dugotrajno opterećenje

$$\zeta = 1 - \beta_1 \cdot \beta_2 \cdot \left(\frac{\sigma_{sr}}{\sigma_s} \right)^2 = 1 - 1.0 \cdot 0.5 \cdot \left(\frac{108.50}{307.12} \right)^2 = 0.938$$

$$\frac{1}{r_I} = 0.0000041 \frac{1}{cm}$$

$$\frac{1}{r_{II}} = 0.0000515 \frac{1}{cm}$$

$$\frac{1}{r_m} = (1 - \zeta) \cdot \frac{1}{r_I} + \zeta \cdot \frac{1}{r_{II}} = (1 - 0.938) \cdot 0.0000041 + 0.938 \cdot 0.0000515 = 0.0000486 \frac{1}{cm}$$

$$k = 0.0888$$

$$L = 505.0 \text{ cm}$$

$$v_{tot,t=0} = k \cdot L^2 \cdot \frac{1}{r_{tot}} = 0.0888 \cdot 505.0^2 \cdot 0.0000486 = 1.11 \text{ cm} < v_{lim} = 2.72 \text{ cm}$$

7. PRORAČUN STUBIŠTA

7.1.MOMENTI SAVIJANJA

- *Granično stanje nosivosti*

Mjerodavna kombinacija: $M_{sd}=1,35*(M_g+M_{\Delta g})+1,5*M_q$

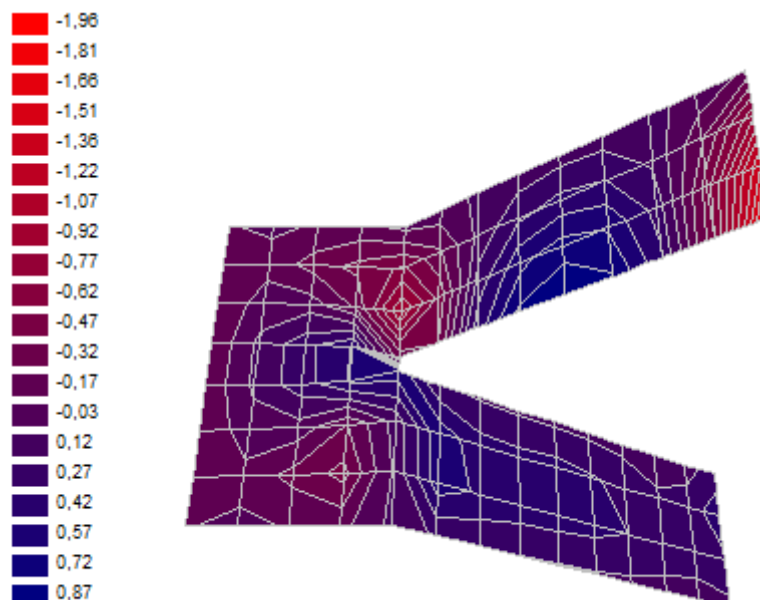

Slika 7.1. Moment M_x (kNm)

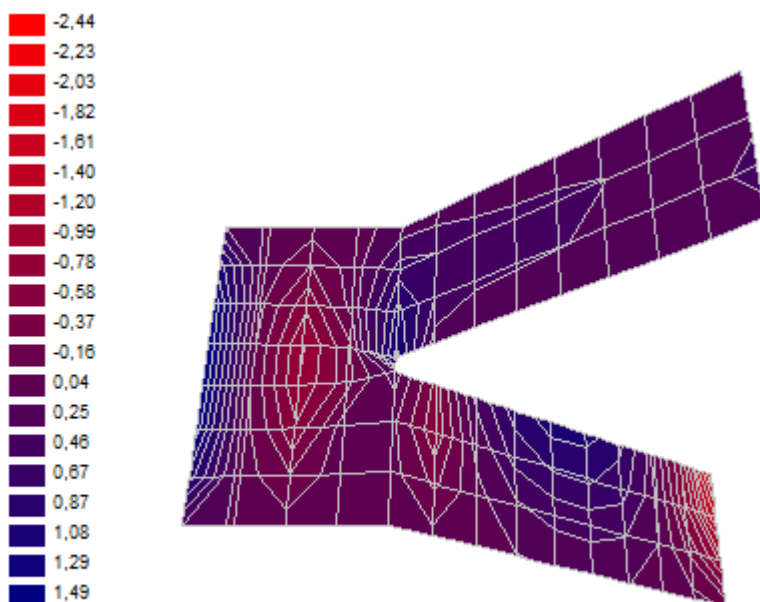

Slika 7.2. Moment M_y (kNm)

7.2.DIMENZIONIRANJE STUBIŠTA

Polje

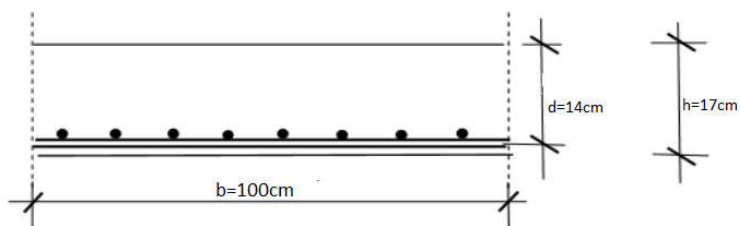

$$M_{Ed} = 1,49 \text{ kNm/m}$$

$$\mu_{sd} = \frac{M_{Ed}}{b \cdot d^2 \cdot f_{cd}} = \frac{149}{100 \cdot 14^2 \cdot 2.0} = 0.004$$

$$\text{Očitano: } \varepsilon_{s1} = 10.0 \text{ ‰} \quad \varepsilon_{c2} = 0.4 \text{ ‰} \quad \xi = 0.038 \quad \zeta = 0.987$$

$$A_{s1} = \frac{M_{Ed}}{\zeta \cdot d \cdot f_{yd}} = \frac{149}{0.987 \cdot 14 \cdot 43.48} = 0,25 \text{ cm}^2/\text{m}$$

Odabrana mreža: **R-166** ($A_s = 1,66 \text{ cm}^2/\text{m}$)

Ležaj

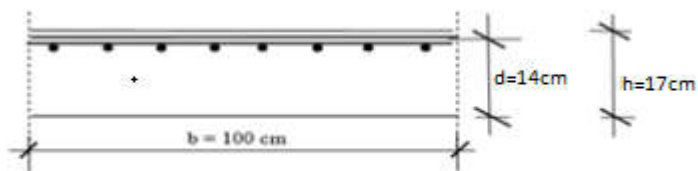

$$M_{Ed} = 2,44 \text{ kNm/m}$$

$$\mu_{sd} = \frac{M_{Ed}}{b \cdot d^2 \cdot f_{cd}} = \frac{244}{100 \cdot 14^2 \cdot 2.0} = 0.0062$$

$$\text{Očitano: } \varepsilon_{s1} = 10.0 \text{ ‰} \quad \varepsilon_{c2} = 0.5 \text{ ‰} \quad \xi = 0.048 \quad \zeta = 0.984$$

$$A_{s1} = \frac{M_{Ed}}{\zeta \cdot d \cdot f_{yd}} = \frac{244}{0.984 \cdot 14 \cdot 43.48} = 0,41 \text{ cm}^2/\text{m}$$

Odabrana armatura: **R- 166** ($A_s = 1,66 \text{ cm}^2/\text{m}$)

8. PRORAČUN ZIDOVA

8.1.POMACI

8.1.1.Prostorni model

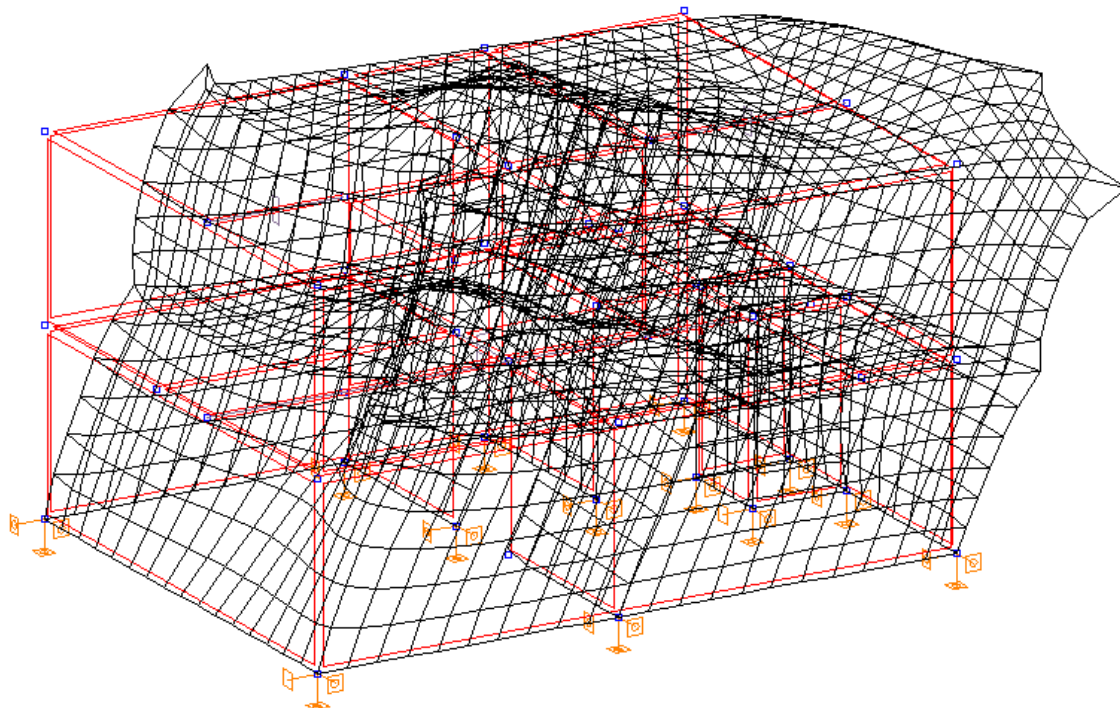

Slika 8.1. Pomaci x-smjer

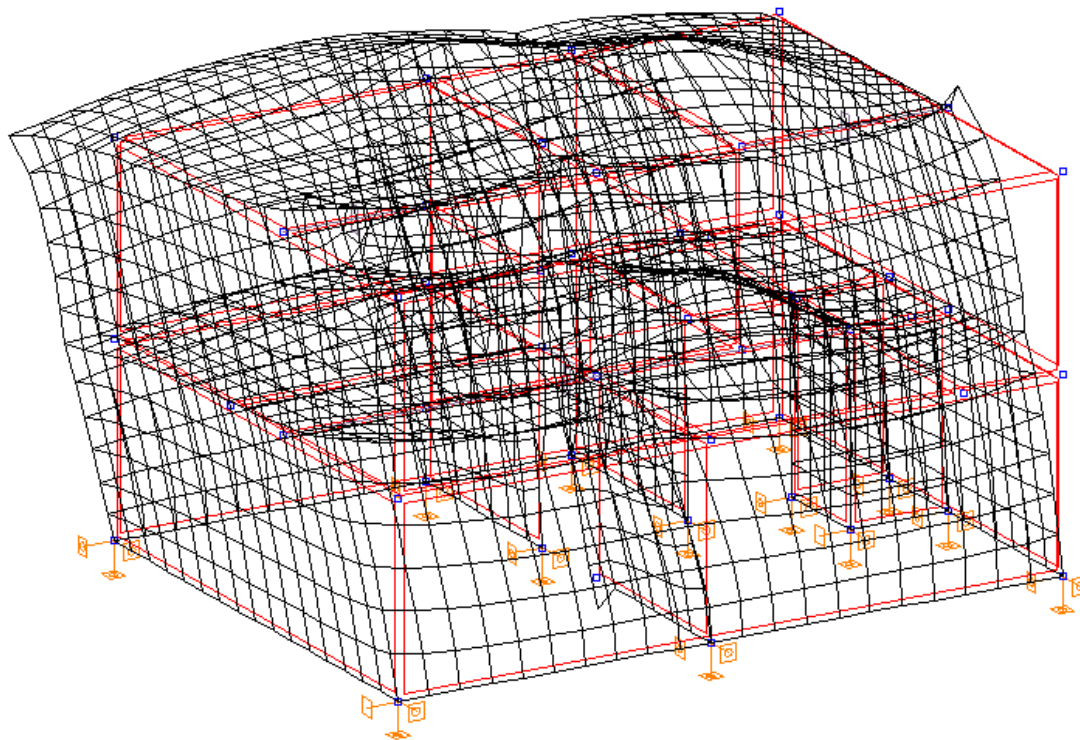

Slika 8.2. Pomaci y-smjer

8.1.2. Štapni model

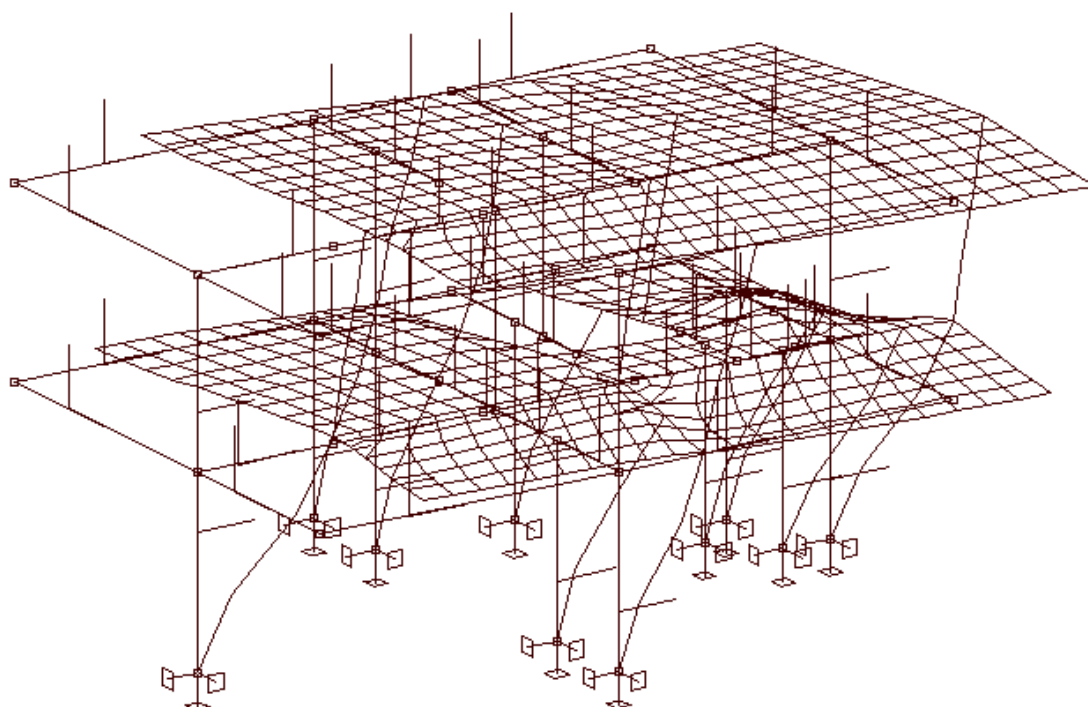

Slika 8.3. Pomaci x-smjer

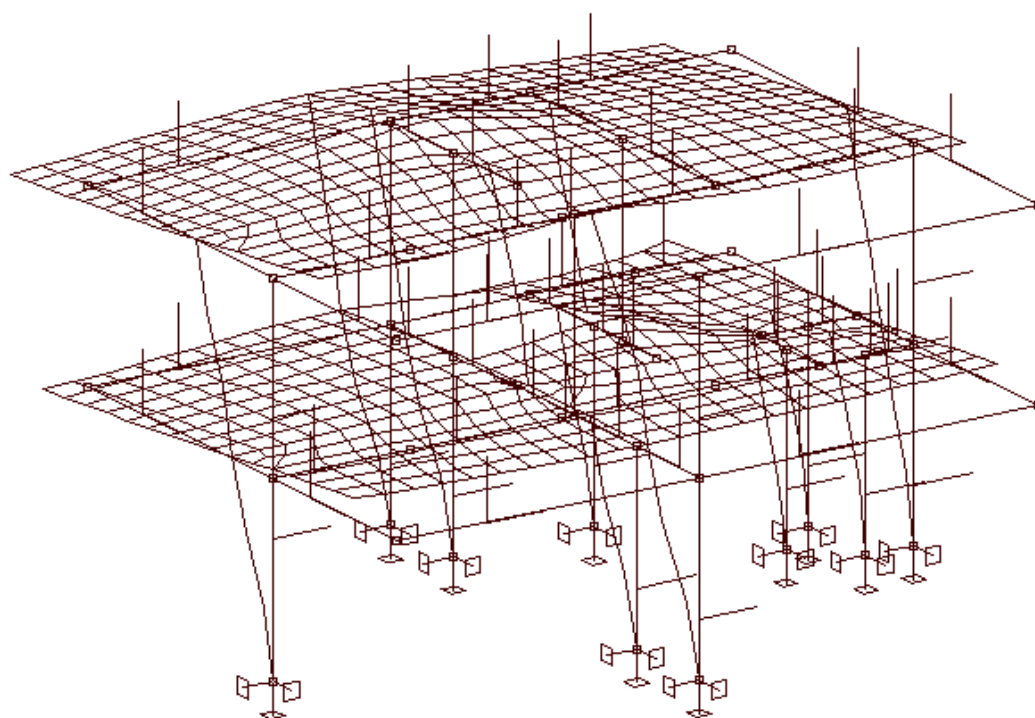

Slika 8.4. Pomaci y-smjer

8.2.MOMENTI SAVIJANJA I UZDUŽNE SILE ZIDOVA

Kombinacije opterećenja s VJETROM (uobičajena kombinacija):

1. kombinacija opterećenja: $1,35 \cdot (g + \Delta g) + 1,5 \cdot q + 1,5 \cdot W_x$

2. kombinacija opterećenja: $1,35 \cdot (g + \Delta g) + 1,5 \cdot q + 1,5 \cdot W_y$

8.2.1. Kombinacija 1

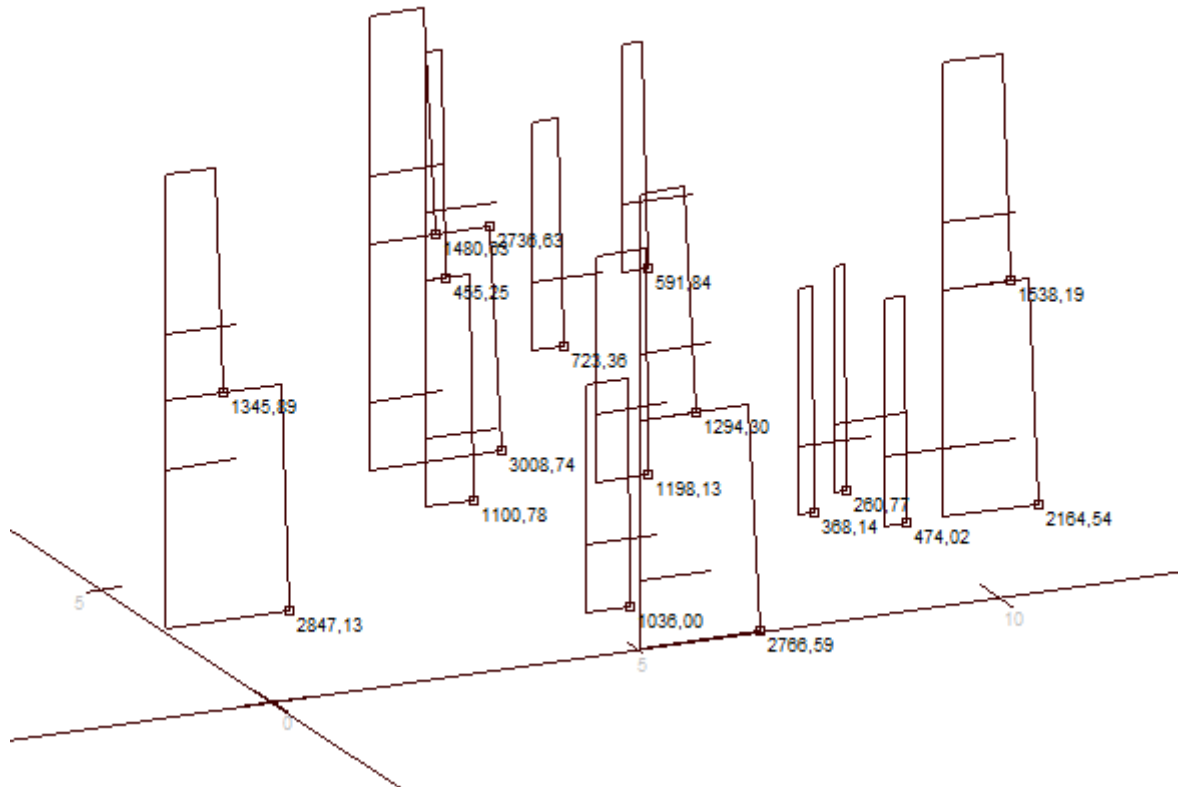

Slika 8.5. Dijagram uzdužnih sila

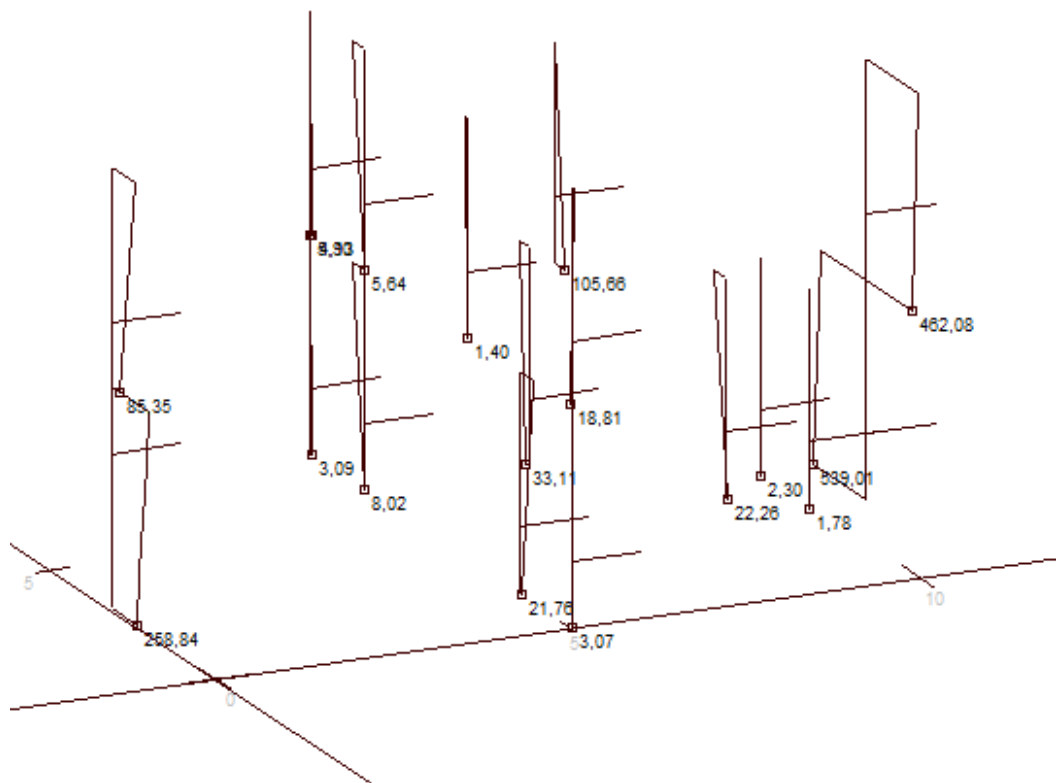

Slika 8.6. Dijagram momenta savijanja M_y

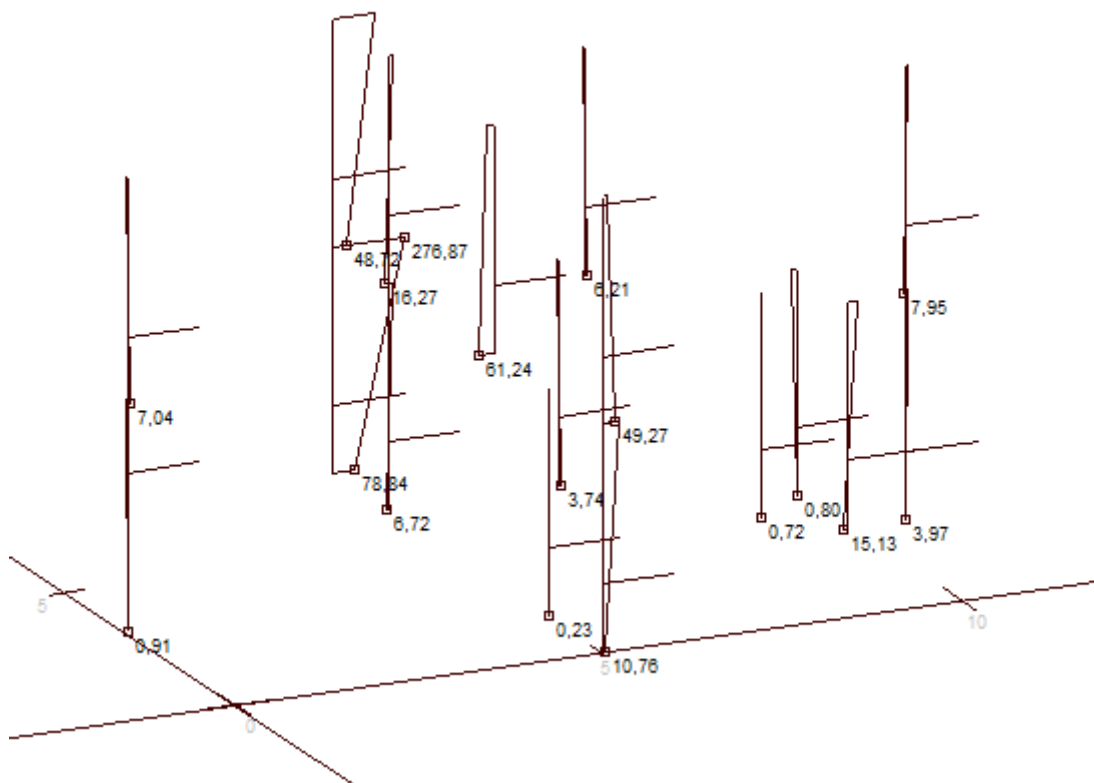

Slika 8.7. Dijagram momenta savijanja M_z

8.2.2. Kombinacija 2

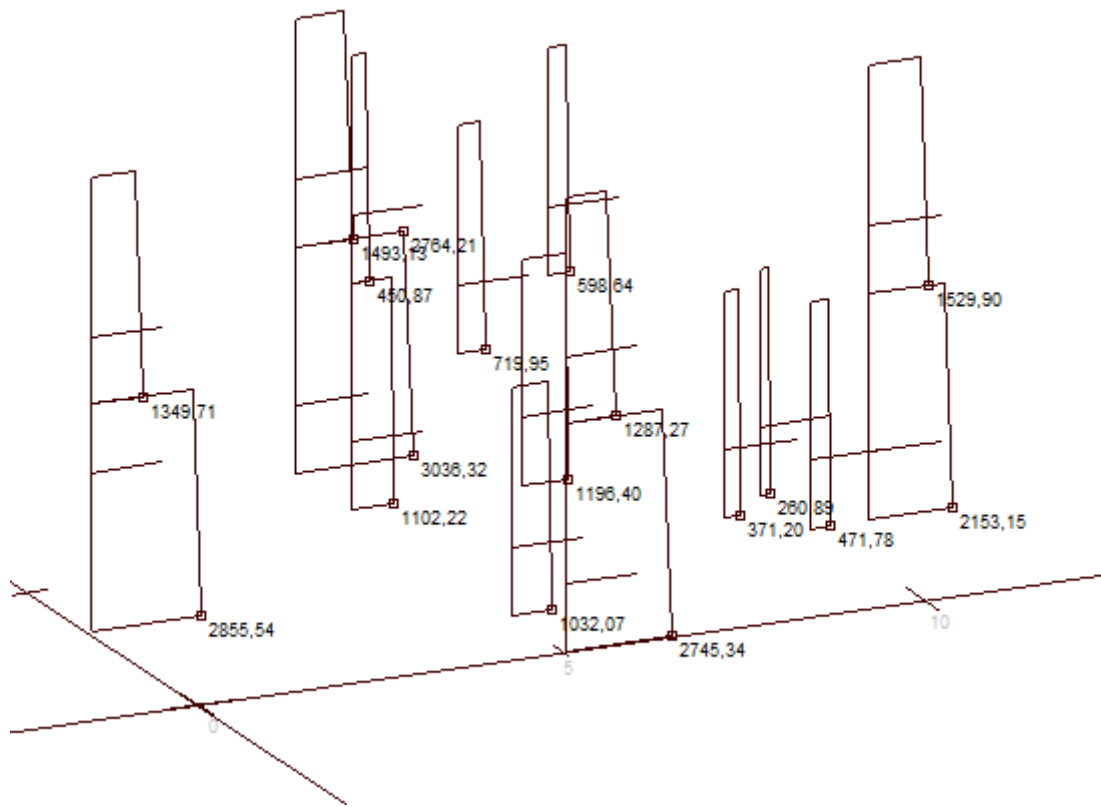

Slika 8.8. Dijagram uzdužnih sila

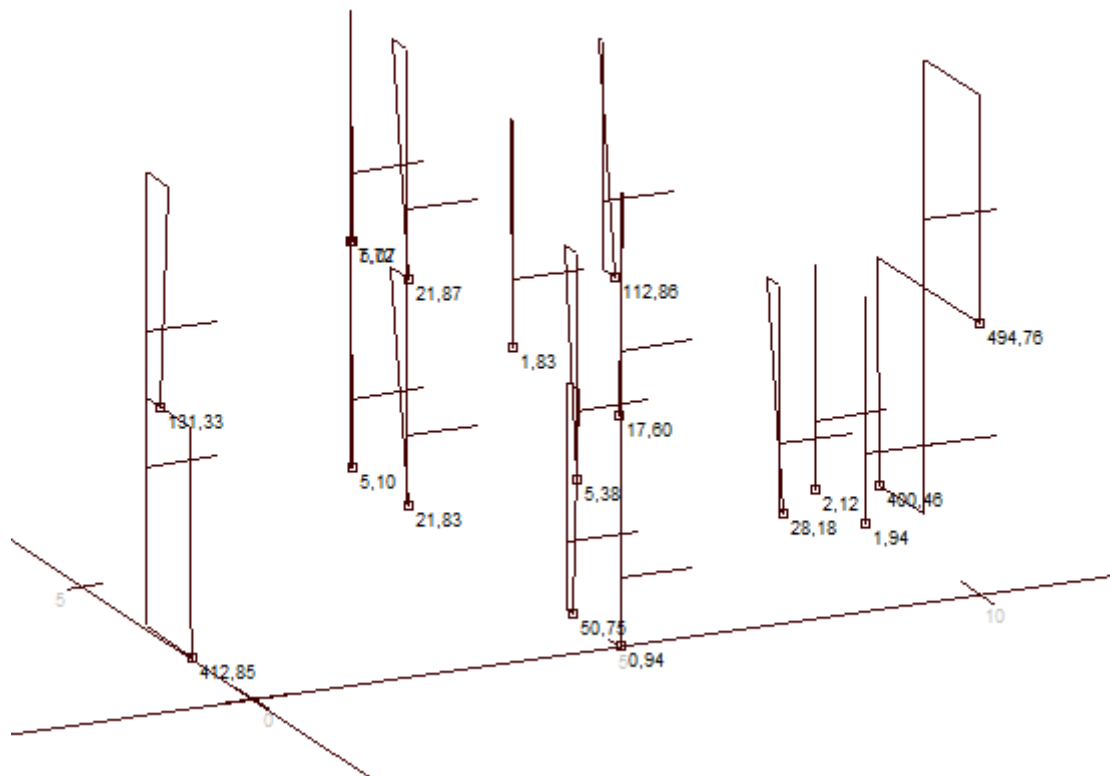

Slika 8.9. Dijagram momenta savijanja M_y

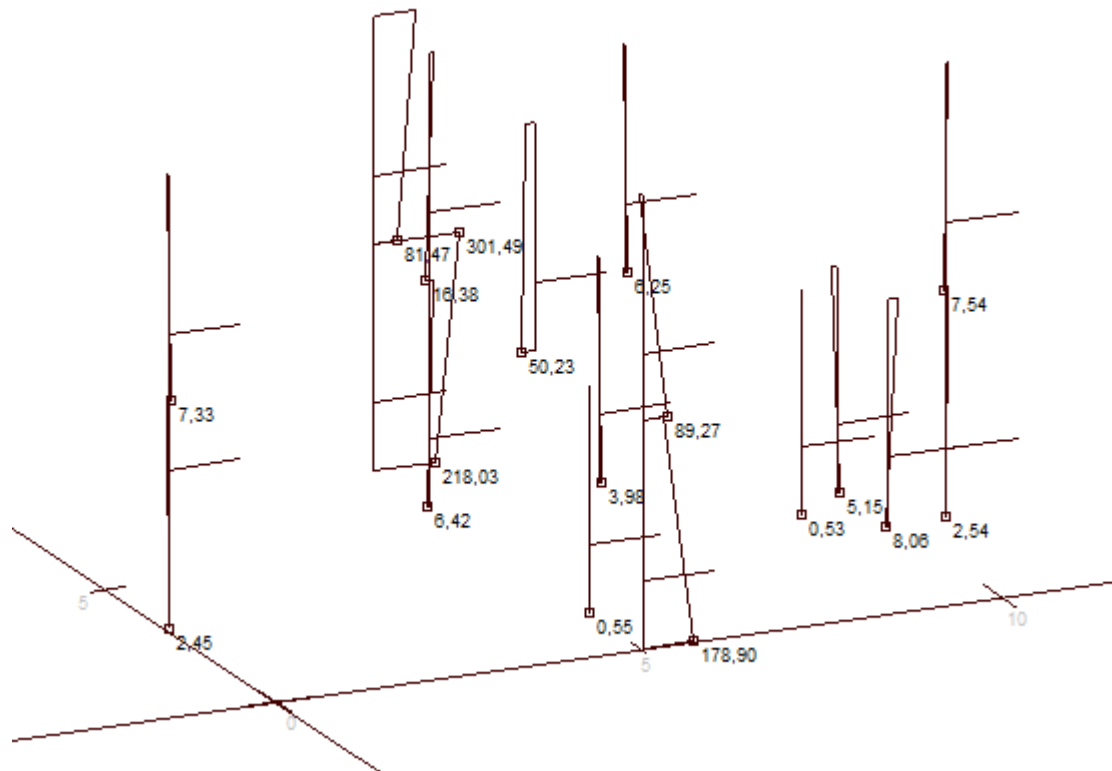

Slika 8.10. Dijagram momenta savijanja M_z

Tablica 8.1. Rezne sile u stupovima

		M(kNm)	N(kN)
1. Kombinacija	MaxN	276,87	-3008,74
2. Kombinacija	Max N	301,49	-3036,32

9. PRORAČUN TEMELJA

9.1.DIMENZIONIRANJE TEMELJA

Temelj je proračunat za granično stanje nosivosti. Za dobivanje mjerodavnih naprezanja na spoju zid – temelj korištene su slijedeće kombinacije opterećenja:

$$1,35 \cdot g_{vl.težina} + 1,35 \cdot g_{dodatno stalno} + 1,5 \cdot q + 1,5 \cdot w_x$$

$$1,35 \cdot g_{vl.težina} + 1,35 \cdot g_{dodatno stalno} + 1,5 \cdot q + 1,5 \cdot w_y$$

- 1. kombinacija: $N = 3008,74 \text{ kN}$
 $M = 267,87 \text{ kNm}$
- 2. kombinacija: $N = 3036,32 \text{ kN}$
 $M = 301,49 \text{ kNm}$

Dopuštena naprezanja u tlu (ovise o vrsti tla): $\sigma_{\text{dop}} = 0,5 \text{ MN/m}^2$

Širina temelja: 0,65 m

Duljina temelja: 11,15 m

Visina temelja: 0,90 m

Težina temelja: $N_t = 11,15 * 0,65 * 0,9 * 25 = 163,10 \text{ kN}$

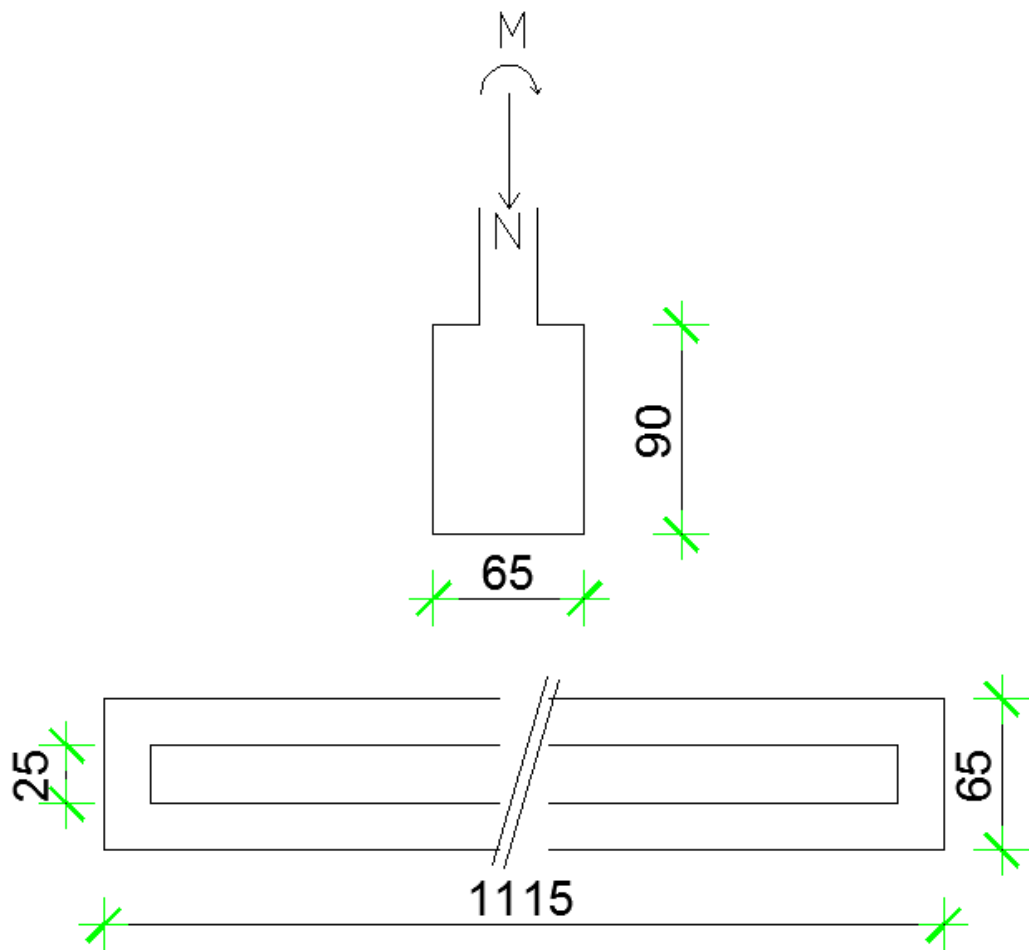

Slika 9.1. Dimenzije temelja

9.2.KONTROLA NAPREZANJA NA DODIRNOJ PLOHI TEMELJ – TLO

$$\sigma_{1,2} = \frac{N}{A} \pm \frac{M}{W}$$

$$A = 11,15 \cdot 0,65 = 7,23 \text{ m}^2$$

$$W = \frac{bh^2}{6} = \frac{0,65 \cdot 11,15^2}{6} = 13,47 \text{ m}^3$$

- 1. kombinacija

$$N = 3008,74 \text{ kN} \quad > N_{Ed} = N + N_i = 3008,74 + 163,10 = 3171,84 \text{ kN}$$

$$M = 267,87 \text{ kNm}$$

$$\sigma_{1,2} = \frac{N}{A} \pm \frac{M}{W} = \frac{3171,84}{7,23} \pm \frac{267,87}{13,47} = 438,71 \pm 19,89$$

$$\sigma_1 = 458,6 \text{ kN/m}^2 < \sigma_{dop,tlo} = 500 \text{ kN/m}^2$$

$$\sigma_2 = 418,82 \text{ kN/m}^2 < \sigma_{dop,tlo} = 500 \text{ kN/m}^2$$

- 2. Kombinacija

$$N = 3036,32 \text{ kN} \quad > N_{Ed} = N + N_i = 3036,32 + 163,10 = 3199,42 \text{ kN}$$

$$M = 301,49 \text{ kNm}$$

$$\sigma_{1,2} = \frac{N}{A} \pm \frac{M}{W} = \frac{3199,42}{7,23} \pm \frac{301,49}{13,47} = 442,52 \pm 22,38$$

$$\sigma_1 = 464,90 \text{ kN/m}^2 < \sigma_{dop,tlo} = 500 \text{ kN/m}^2$$

$$\sigma_2 = 420,14 \text{ kN/m}^2 < \sigma_{dop,tlo} = 500 \text{ kN/m}^2$$

9.3. PRORAČUN ARMATURE TEMELJA

➤ Momenti u presjeku 1-1

$$M_{1-1} = \sigma_{1-1} \cdot b_1 \cdot \frac{b_1}{2} + (\sigma_1 - \sigma_{1-1}) \cdot \frac{b_1}{2} \cdot \frac{2}{3} \cdot b_1$$

$$\sigma_{1-1} = \sigma_1 - \frac{b_1}{b} \cdot (\sigma_1 - \sigma_2)$$

• 1. kombinacija

$$\sigma_{1-1} = 458,6 - \frac{0,20}{11,15} \cdot (458,6 - 418,82) = 457,89 \text{ kPa}$$

$$M_{1-1} = 457,89 \cdot 0,20 \cdot \frac{0,20}{2} + (458,6 - 457,89) \cdot \frac{0,20}{2} \cdot \frac{2}{3} \cdot 0,20$$

$$M_{1-1} = 9,15 \text{ kNm}$$

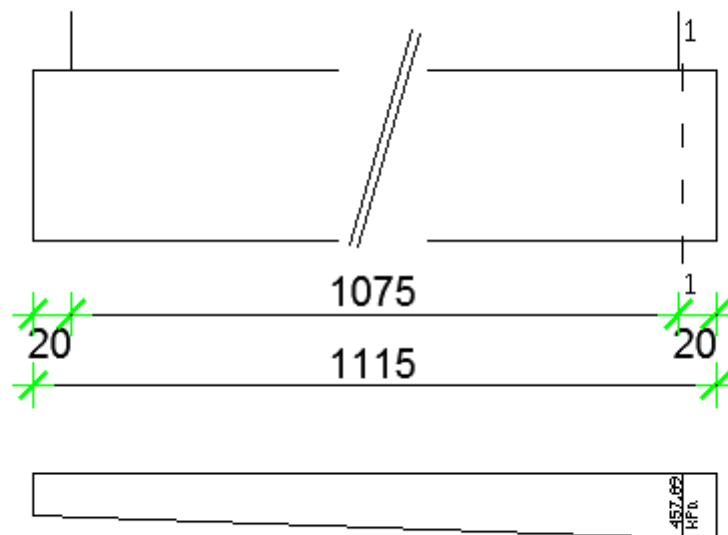

Slika 10.2. Naprezanje ispod temelja za kombinaciju 1

- 2. kombinacija

$$\sigma_{1-1} = 469,90 - \frac{0,20}{11,15} \cdot (469,90 - 420,14) = 464,1 \text{ kPa}$$

$$M_{1-1} = 464,1 \cdot 0,20 \cdot \frac{0,20}{2} + (469,90 - 464,1) \cdot \frac{0,20}{2} \cdot \frac{2}{3} \cdot 0,20$$

$$M_{1-1} = 9,36 \text{ kNm}$$

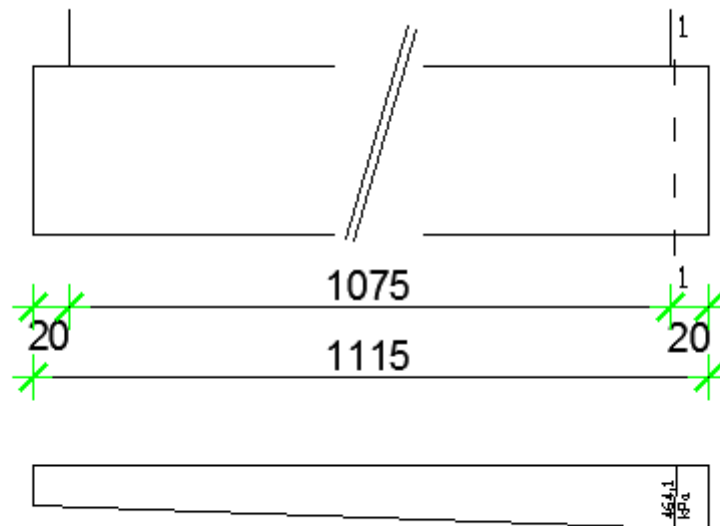

Slika 10.3. Naprezanje ispod temelja za kombinaciju 2

Mjerodavni moment za proračun armature:

$$M_{1-1} = 9,36 \text{ kNm}$$

$$\text{Klasa betona: C40/50} \rightarrow f_{ck} = 30 \text{ MPa} \rightarrow f_{cd} = \frac{30}{1,5} = 20,00 \text{ MPa} = 2,00 \text{ kN/cm}^2$$

$$\text{Zadana armatura: B500B} \rightarrow f_{yk} = 500 \text{ MPa} \rightarrow f_{yd} = \frac{500}{1,15} = 434,78 \text{ MPa} = 43,48 \text{ kN/cm}^2$$

$$\mu_{sd} = \frac{M_{sd}}{b \cdot d^2 \cdot f_{cd}} = \frac{9,36 \cdot 100}{100 \cdot 85^2 \cdot 2,00} = 0,001$$

Očitano: $\epsilon_{s1} = 10,0 \text{ ‰}$, $\epsilon_{c2} = 0,2 \text{ ‰}$, $\xi = 0,020$, $\zeta = 0,993$

$$A_{s1} = \frac{M_{sd,1-1}}{f_{yd} \cdot \zeta \cdot d} = \frac{9,36 \cdot 100}{43,48 \cdot 0,993 \cdot 85} = 0,25 \text{ cm}^2/\text{m}'$$

$$A_{s1} = \frac{0,25}{0,65} = 0,38 \left(\frac{\text{cm}^2}{\text{m}'} \right)$$

Odabrana armatura:

$$A_{s1, \text{odabrano}} = 0,38 \left(\frac{\text{cm}^2}{\text{m}'} \right)$$

U donju zonu temelja:

Odabrana armatura: mreža Q131 ($A_{s1} = 1,31 \text{ cm}^2/\text{m}'$)

Konstruktivna armatura u gornjoj zoni: mreža Q131 ($A_{s1} = 1,31 \text{ cm}^2/\text{m}$)

10. PRILOZI

10.1. ARMATURA PLOČE POZICIJA 100- DONJA ZONA

10.2. ARMATURA PLOČE POZICIJA 100- GORNJA ZONA

10.3. ARMATURA PLOČE POZICIJA 200- DONJA ZONA

10.4. ARMATURA PLOČE POZICIJA 200- GORNJA ZONA

10.5. ARMATURNI PLAN GREDE

10.6. ARMATURNI PLAN STUBIŠTA



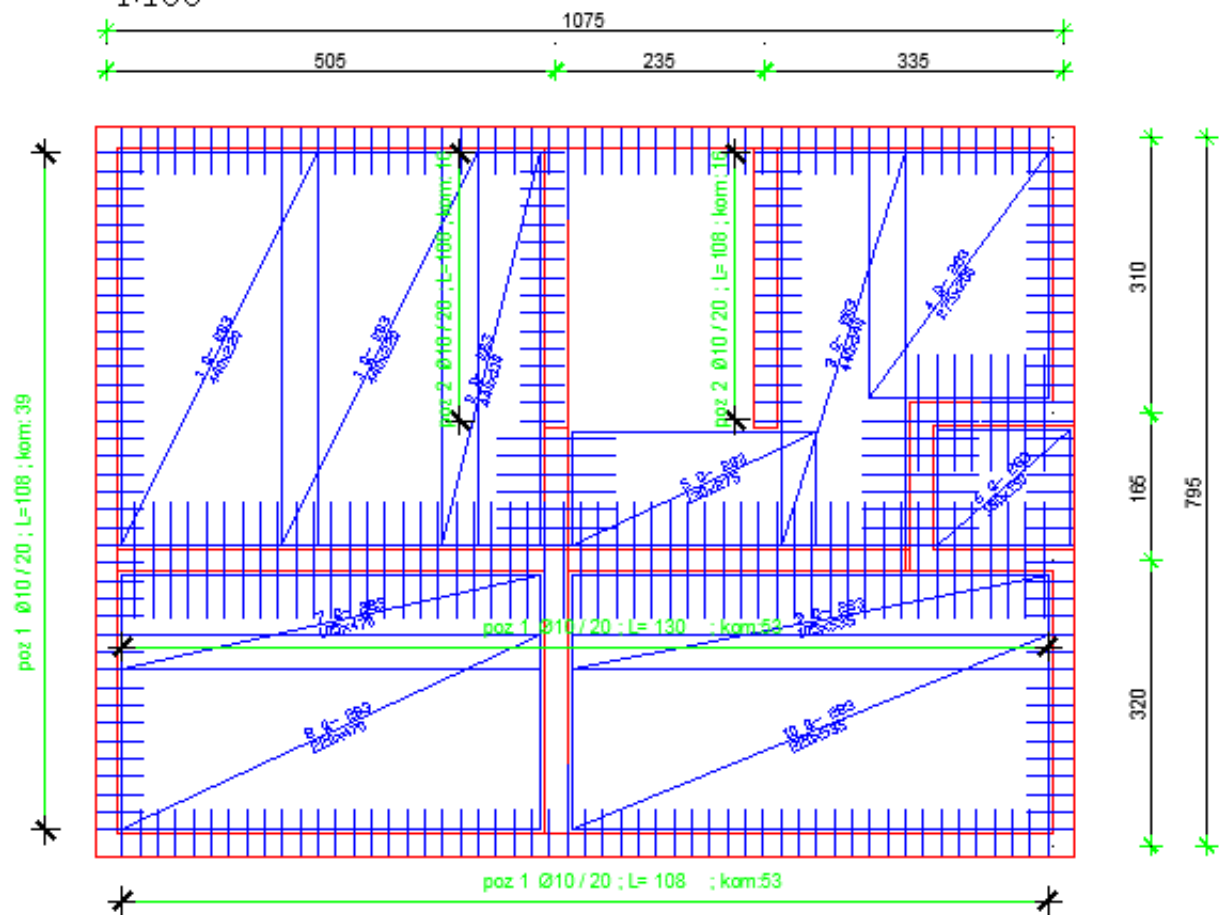



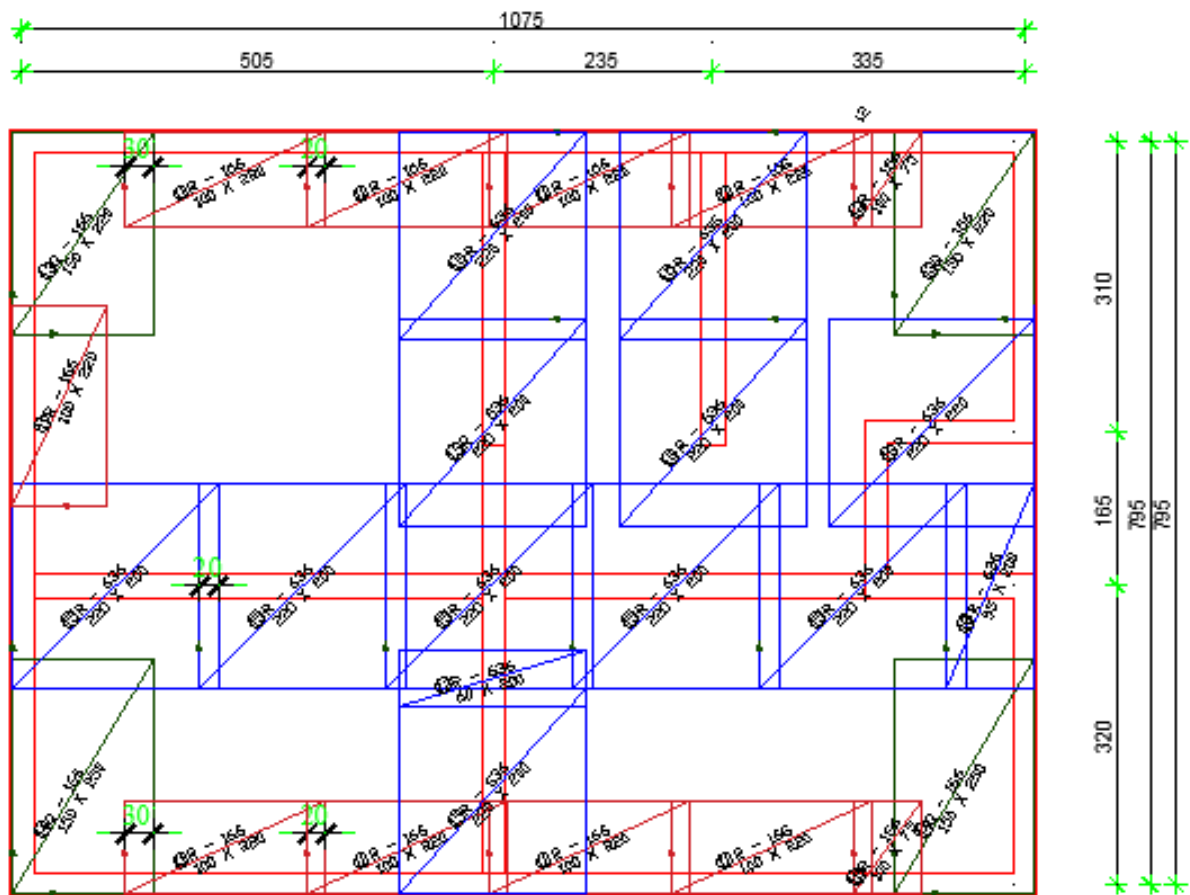











Armatura ploče pozicija 100 - donja zona 1:100



Armatura ploče pozicija 100 - gornja zona zona
1:100



ISKAZ MREŽASTE ARMATURE Čelik B500B

POZ.	TIP MREŽE	OBLIK	DIMENZIJE (cm)	KOM.	MASA (kg/m ²)	UKUPNA MASA
1	Q-283		220x440	2	4,48	8,96
2	Q-283		110x440	1	4,48	4,48
3	Q-283		140x440	1	4,48	4,48
4	Q-283		200x275	1	4,48	4,48
5	Q-283		130x275	1	4,48	4,48
6	Q-283		130x150	1	4,48	4,48
7	Q-283		105x470	1	4,48	4,48
8	Q-283		220x470	1	4,48	4,48
9	Q-283		105x535	1	4,48	4,48
10	Q-283		220x535	1	4,48	4,48
11	R-166		100x220	9	1,76	15,84
12	R-166		100x75	2	1,76	3,52
13	Q-166		150x220	2	2,64	5,28
14	Q-166		150x250	2	2,64	5,28
15	R-636		220x200	10	5,95	59,5
16	R-636		220x220	1	5,95	5,95
17	R-636		60x200	1	5,95	5,95
18	R-636		95x200	1	5,95	5,95
UKUPNO:156,55(KG)						

Armatura ploče pozicija 200 - donja zona 1:100

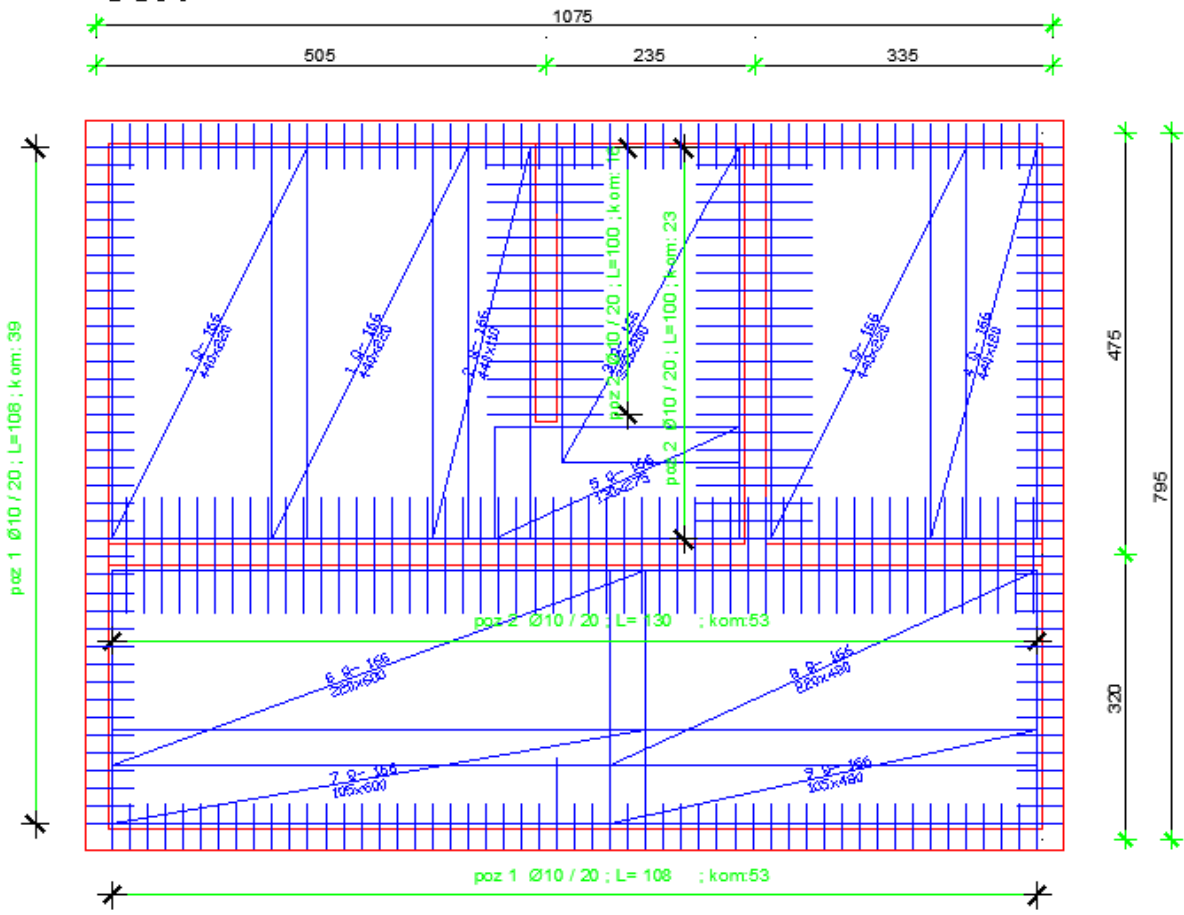



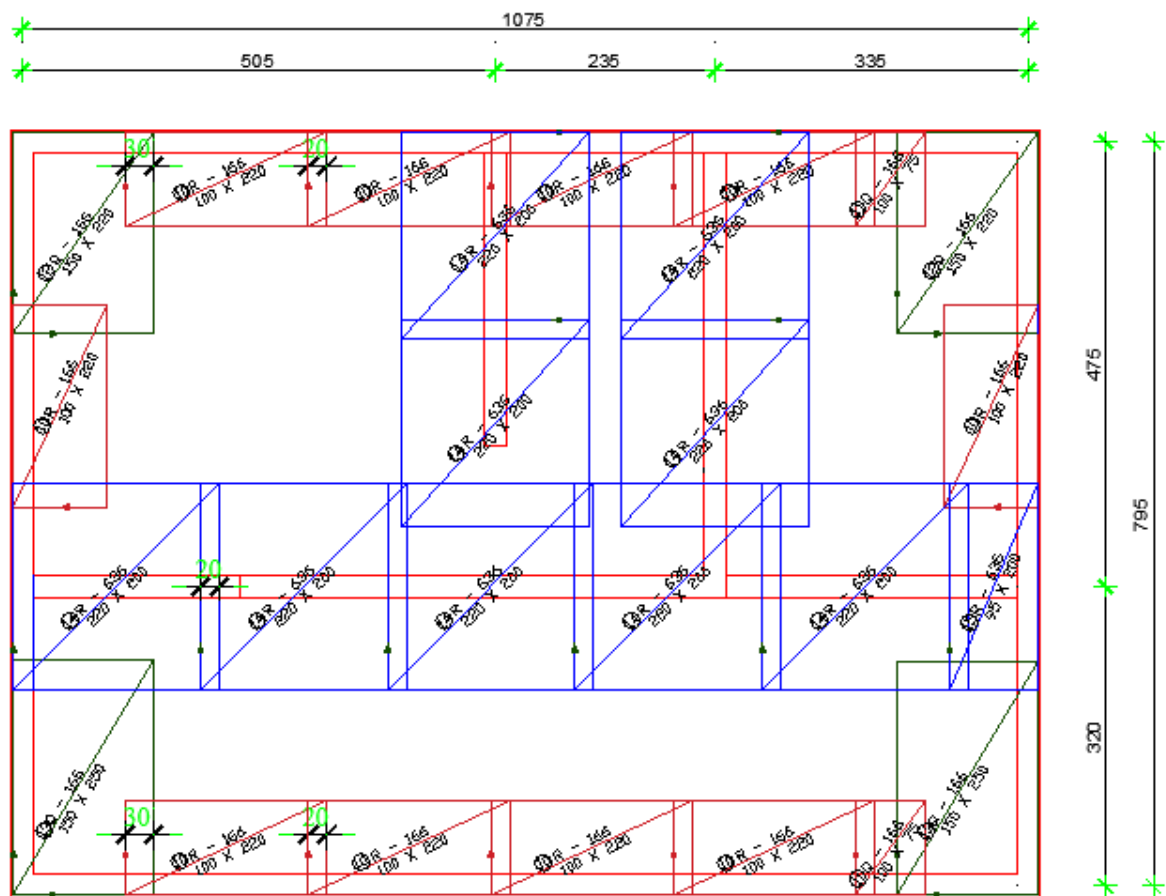











Armatura ploče pozicija 200 - gornja zona zona 1:100



ISKAZ MREŽASTE ARMATURE

Čelik B500B

POZ.	TIP MREŽE	OBLIK	DIMENZIJE (cm)	KOM.	MASA (kg/m ²)	UKUPNA MASA
1	Q-166		220x440	3	2,64	7,92
2	Q-166		110x440	1	2,64	2,64
3	Q-166		200x350	1	2,64	2,64
4	Q-166		120x440	1	2,64	2,64
5	Q-166		130x275	1	2,64	2,64
6	Q-166		220x600	1	2,64	2,64
7	Q-166		105x600	1	2,64	2,64
8	Q-166		220x480	1	2,64	2,64
9	Q-166		105x480	1	2,64	2,64
10	R-166		100x220	10	1,76	17,60
11	R-166		100x75	2	1,76	3,52
12	Q-166		150x220	2	2,64	5,28
13	Q-166		150x250	2	2,64	5,28
14	R-636		220x200	9	5,95	53,55
15	R-636		95x200	1	5,95	5,95
UKUPNO						120,22(KG)

ARMATURNI PLAN GREDE

GORNJA ZONA

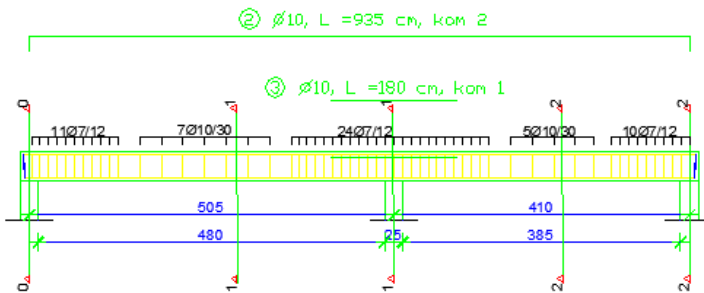

DONJA ZONA

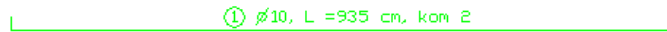

⊕ $\varnothing 7/12/30\text{cm}$; L=122 cm, 61 kom

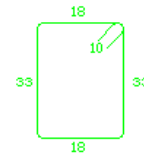

ISKAZ UZDUŽNIH ŠIFKI B 500 B					
POZ	Ø	OBLIK I DIMANZIJE	DULJINA (m)	KOMADA	UKUPNA DULJINA PO PROFILIMA (m)
1	10		9,55	2	18,9
2	10		9,55	2	18,9
3	10		1,8	1	1,8

ISKAZ VILICA B 500 B					
POZ	Ø	OBLIK I DIMANZIJE	DULJINA (m)	KOMADA	UKUPNA DULJINA (m)
4	7		1,22	57	70

PRIKAZ UZDUŽNE ARMATURE

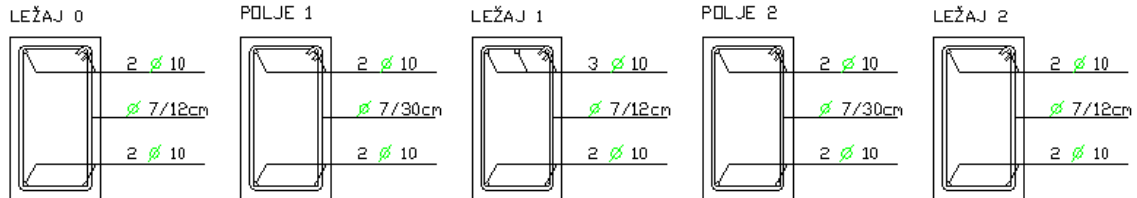

ARMATURNI PLAN STUBIŠTA

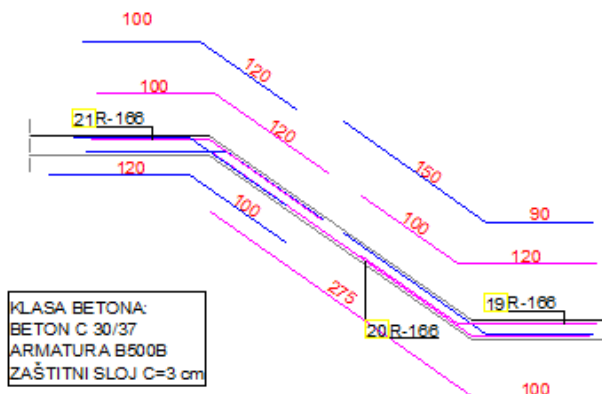

Pozicija	Oznaka mreže	B [cm]	L [cm]	n	Jedinična težina [kg/m ²]	Ukupna težina [kg]
ARMATURA STUBIŠTA						
19	R-166	90	220	2	1,76	6,97
20	R-166	90	375	2	1,76	11,88
21	R-166	90	220	1	1,76	3,48
Ukupno						22,33
oblik i dimenzije [cm]		Ø	lg [m]	Jedinična težina [kg/m ³]		
		10	2,20	0,79		
		10	2,20	0,79		
		10	2,40	0,79		

11.LITERATURA

Radnić J.,Harapin A. Osnove betonskih konstrukcija,interna skripta.

Fakultet građevinarstva arhitekture i geodezijeu Splitu,studeni 2013.

V. Herak Marović: Betonske konstrukcije 2, nastavni tekst (predavanja, vježbe) na web stranici

V. Herak Marović: Betonske konstrukcije 1, nastavni tekst (predavanja, vježbe) na web stranici