

Analiza šasije

Mamula, Ivana

Supplement / Prilog

Publication year / Godina izdavanja: **2015**

Permanent link / Trajna poveznica: <https://urn.nsk.hr/urn:nbn:hr:128:920703>

Rights / Prava: [In copyright](#) / [Zaštićeno autorskim pravom.](#)

Download date / Datum preuzimanja: **2024-08-19**



VELEUČILIŠTE U KARLOVCU
Karlovac University of Applied Sciences

Repository / Repozitorij:

[Repository of Karlovac University of Applied
Sciences - Institutional Repository](#)

Statička analiza

Datum: 21. rujan 2015.
Konstruktor: Ivana Mamula
Ime analize: Static
Tip analize: Statička

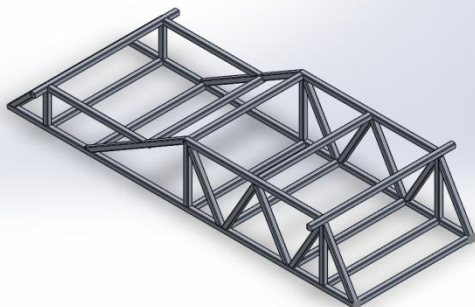

Sadržaj

Opis	1
Informacije o modelu	2
Mjerne jedinice	10
Karakteristike materijala	11
Sile i uklještenja	12
Mreža	13
Rezultirajuće vrijednosti	14
Rezultati	15

Opis

Šasija solarnog automobila

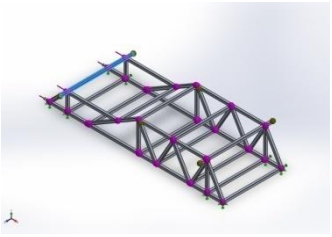
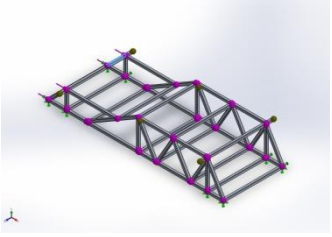
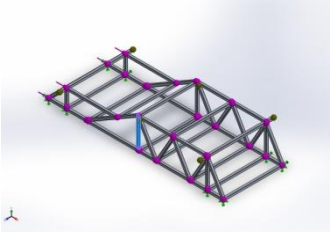
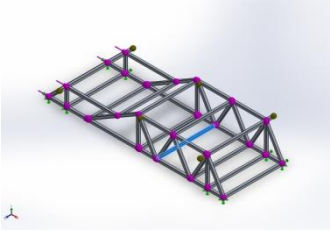

Informacije o modelu

<p>Element-1</p> 	<p>Gredni element</p>	<p>Presjek-ISO/cijev/40 x 40 x 4 Površina presjeka: 371612.16mm² Dužina:1250mm Volumen:0.00072m³ Masena gustoća:2700kg/m³ Masa:1.944kg Težina:19.0512N</p>
<p>Element-2</p> 	<p>Gredni element</p>	<p>Presjek-ISO/cijev/40 x 40 x 4 Površina presjeka: 371612.16mm² Dužina:384.264mm Volumen:0.000221337m³ Masena gustoća:2700kg/m³ Masa:0.597611kg Težina:5.85658N</p>
<p>Element-3</p> 	<p>Gredni element</p>	<p>Presjek-ISO/cijev/40 x 40 x 4 Površina presjeka: 371612.16mm² Dužina:480mm Volumen:0.000276481m³ Masena gustoća:2700kg/m³ Masa:0.746498kg Težina:7.31568N</p>
<p>Element-4</p> 	<p>Gredni element</p>	<p>Presjek-ISO/cijev/40 x 40 x 4 Površina presjeka: 371612.16mm² Dužina:960mm Volumen:0.00055296m³ Masena gustoća:2700kg/m³ Masa:1.49299kg Težina:14.6313N</p>

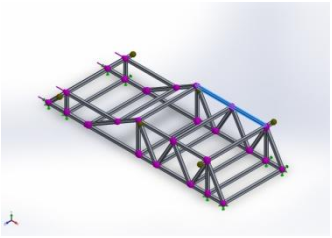
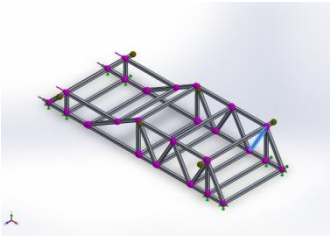
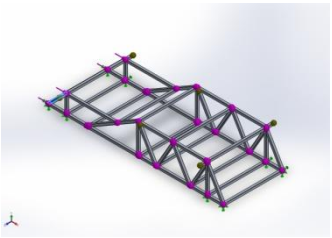
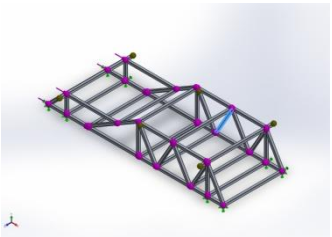
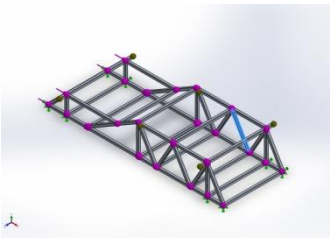
<p>Element-5</p> 	<p>Gredni element</p>	<p>Presjek-ISO/cijev/40 x 40 x 4 Površina presjeka: 576in² Dužina:1154.7mm Volumen:0.000665107m³ Masena gustoća:2700kg/m³ Masa:1.79579kg Težina:17.5987N</p>
<p>Element-6</p> 	<p>Gredni element</p>	<p>Presjek-ISO/cijev/40 x 40 x 4 Površina presjeka: 371612.16mm² Dužina:488.368mm Volumen:0.000282618m³ Masena gustoća:2700kg/m³ Masa:0.763069kg Težina:7.47808N</p>
<p>Element-7</p> 	<p>Gredni element</p>	<p>Presjek-ISO/cijev/40 x 40 x 4 Površina presjeka: 371612.16mm² Dužina:384.264mm Volumen:0.000221337m³ Masena gustoća:2700kg/m³ Masa:0.597611kg Težina:5.85658N</p>
<p>Element-8</p> 	<p>Gredni element</p>	<p>Presjek-ISO/cijev/40 x 40 x 4 Površina presjeka: 371612.16mm² Dužina:508.068mm Volumen:0.000292645m³ Masena gustoća:2700kg/m³ Masa:0.790143kg Težina:7.7434N</p>
<p>Element-9</p> 	<p>Gredni element</p>	<p>Presjek-ISO/cijev/40 x 40 x 4 Površina presjeka: 371612.16mm² Dužina:531.162mm Volumen:0.000305947m³ Masena gustoća:2700kg/m³ Masa:0.826058kg Težina:8.09537N</p>

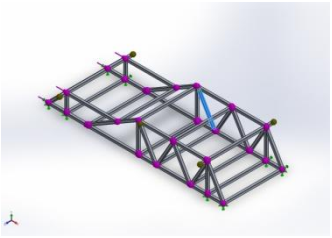
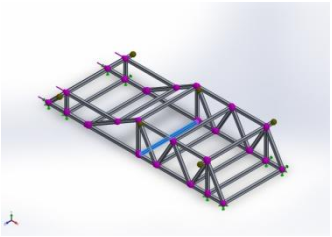
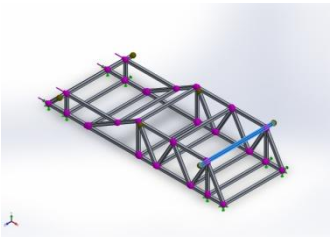
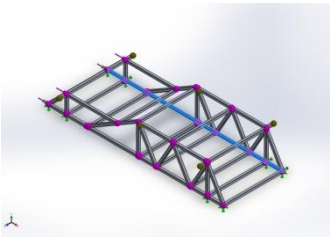
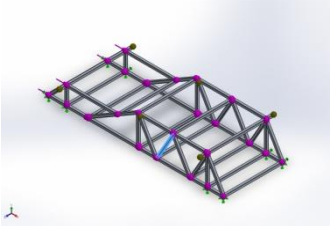
<p>Element-10</p> 	<p>Gredni element</p>	<p>Presjek-ISO/cijev/40 x 40 x 4 Površina presjeka: 371612.16mm² Dužina:513.608mm Volumen:0.00029703m³ Masena gustoća:2700kg/m³ Masa:0.801982kg Težina:7.85943N</p>
<p>Element-11</p> 	<p>Gredni element</p>	<p>Presjek-ISO/cijev/40 x 40 x 4 Površina presjeka: 371612.16mm² Dužina:960mm Volumen:0.00055296m³ Masena gustoća:2700kg/m³ Masa:1.49299kg Težina:14.6313N</p>
<p>Element-12</p> 	<p>Gredni element</p>	<p>Presjek-ISO/cijev/40 x 40 x 4 Površina presjeka: 371612.16mm² Dužina:1250mm Volumen:0.00072m³ Masena gustoća:2700kg/m³ Masa:1.944kg Težina:19.0512N</p>
<p>Element-13</p> 	<p>Gredni element</p>	<p>Presjek-ISO/cijev/40 x 40 x 4 Površina presjeka: 371612.16mm² Dužina:2965mm Volumen:0.00170784m³ Masena gustoća:2700kg/m³ Masa:4.61118kg Težina:45.1896N</p>
<p>Element-14</p> 	<p>Gredni element</p>	<p>Presjek-iso/cijev/40 x 40 x 4 Section Area: 576in² Dužina:508.068mm Volumen:0.000292645m³ Masena gustoća:2700kg/m³ Masa:0.790143kg Težina:7.7434N</p>

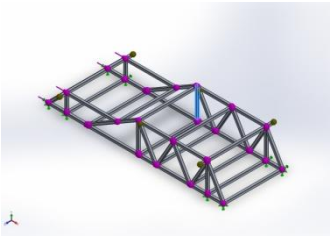
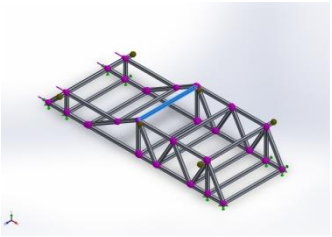
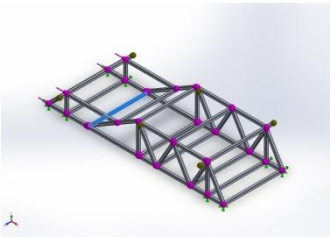
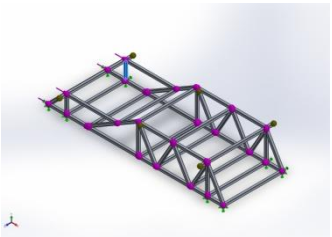
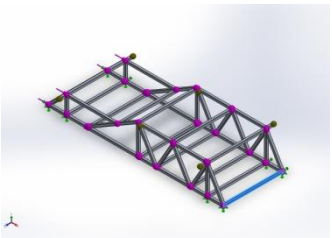
<p>Element-15</p> 	<p>Gredni element</p>	<p>Presjek-ISO/cijev/40 x 40 x 4 Površina presjeka: 371612.16mm² Dužina:480mm Volumen:0.000276481m³ Masena gustoća:2700kg/m³ Masa:0.746498kg Težina:7.31568N</p>
<p>Element-16</p> 	<p>Gredni element</p>	<p>Presjek-ISO/cijev/40 x 40 x 4 Površina presjeka: 371612.16mm² Dužina:960mm Volumen:0.00055296m³ Masena gustoća:2700kg/m³ Masa:1.49299kg Težina:14.6313N</p>
<p>Element-17</p> 	<p>Gredni element</p>	<p>Presjek-ISO/cijev/40 x 40 x 4 Površina presjeka: 371612.16mm² Dužina:960mm Volumen:0.00055296m³ Masena gustoća:2700kg/m³ Masa:1.49299kg Težina:14.6313N</p>
<p>Element-18</p> 	<p>Gredni element</p>	<p>Presjek-ISO/cijev/40 x 40 x 4 Površina presjeka: 371612.16mm² Dužina:260mm Volumen:0.00014976m³ Masena gustoća:2700kg/m³ Masa:0.404352kg Težina:3.96265N</p>
<p>Element-19</p> 	<p>Gredni element</p>	<p>Presjek-ISO/cijev/40 x 40 x 4 Površina presjeka: 371612.16mm² Dužina:1000mm Volumen:0.000576002m³ Masena gustoća:2700kg/m³ Masa:1.5552kg Težina:15.241N</p>

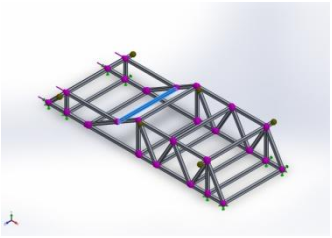
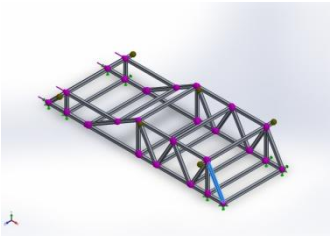
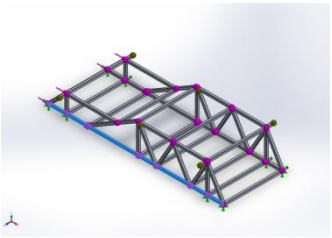
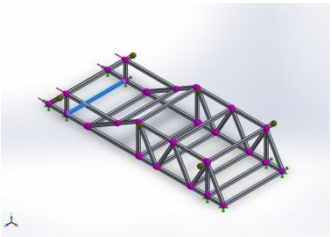
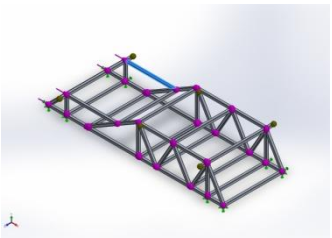
<p>Element-20</p> 	<p>Gredni element</p>	<p>Presjek-iso/cijev/40 x 40 x 4 Površina presjeka: 371612.16mm² Dužina:970.436mm Volumen:0.000558971m³ Masena gustoća:2700kg/m³ Masa:1.50922kg Težina:14.7904N</p>
<p>Greda-21</p> 	<p>Gredni element</p>	<p>Presjek-ISO/cijev/40 x 40 x 4 Površina presjeka: 371612.16mm² Dužina:491.162mm Volumen:0.000282908m³ Masena gustoća:2700kg/m³ Masa:0.763852kg Težina:7.48575N</p>
<p>Element-22</p> 	<p>Gredni element</p>	<p>Presjek-ISO/cijev/40 x 40 x 4 Površina presjeka: 371612.16mm² Dužina:2965mm Volumen:0.00170784m³ Masena gustoća:2700kg/m³ Masa:4.61118kg Težina:45.1896N</p>
<p>Element-23</p> 	<p>Gredni element</p>	<p>Presjek-ISO/cijev/40 x 40 x 4 Površina presjeka: 371612.16mm² Dužina:960mm Volumen:0.00055296m³ Masena gustoća:2700kg/m³ Masa:1.49299kg Weight:14.6313N</p>
<p>Element-24</p> 	<p>Gredni element</p>	<p>Presjek-ISO/cijev/40 x 40 x 4 Površina presjeka: 371612.16mm² Dužina:795.573mm Volumen:0.000458252m³ Masena gustoća:2700kg/m³ Masa:1.23728kg Težina:12.1253N</p>

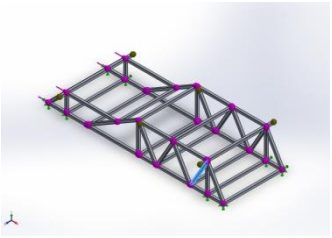
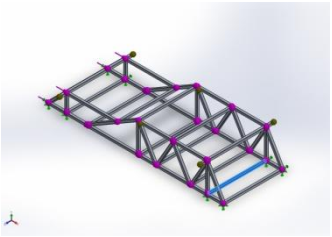
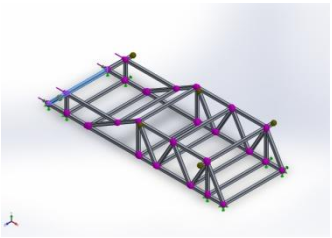
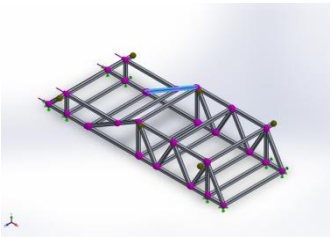
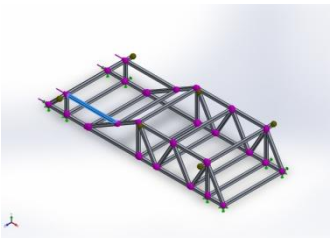
<p>Element-25</p> 	<p>Gredni element</p>	<p>Presjek-ISO/cijev/40 x 40 x 4 Površina presjeka: 371612.16mm² Dužina:488.368mm Volumen:0.000282619m³ Masena gustoća:2700kg/m³ Masa:0.763071kg Težina:7.47809N</p>
<p>Element-26</p> 	<p>Gredni element</p>	<p>Presjek-ISO/cijev/40 x 40 x 4 Površina presjeka: 371612.16mm² Dužina:960mm Volumen:0.00055296m³ Masena gustoća:2700kg/m³ Masa:1.49299kg Težina:14.6313N</p>
<p>Element-27</p> 	<p>Gredni element</p>	<p>Presjek-ISO/cijev/40 x 40 x 4 Površina presjeka: 371612.16mm² Dužina:1000mm Volumen:0.000576002m³ Masena gustoća:2700kg/m³ Masa:1.5552kg Težina:15.241N</p>
<p>Element-28</p> 	<p>Gredni element</p>	<p>Presjek-ISO/cijev/40 x 40 x 4 Površina presjeka: 371612.16mm² Dužina:953.812mm Volumen:0.000549392m³ Masena gustoća:2700kg/m³ Masa:1.48336kg Težina:14.5369N</p>
<p>Element-29</p> 	<p>Gredni element</p>	<p>Presjek-ISO/cijev/40 x 40 x 4 Površina presjeka: 371612.16mm² Dužina:795.573mm Volumen:0.000458251m³ Masena gustoća:2700kg/m³ Masa:1.23728kg Težina:12.1253N</p>

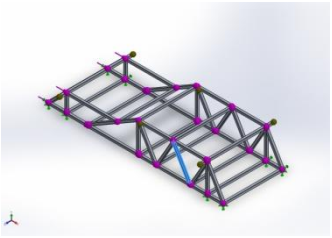
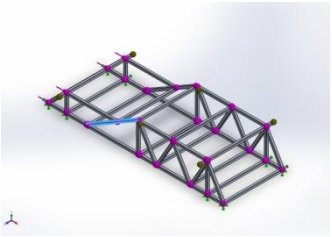
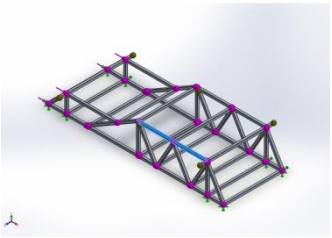
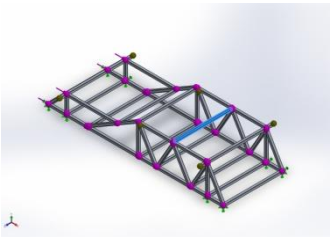
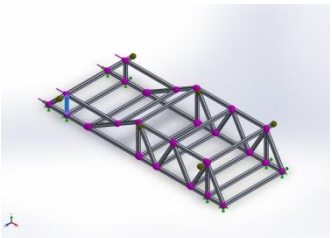
<p>Element-30</p> 	<p>Gredni element</p>	<p>Presjek-ISO/cijev/40 x 40 x 4 Površina presjeka: 371612.16mm² Dužina:531.162mm Volumen:0.000305947m³ Masena gustoća:2700kg/m³ Masa:0.826058kg Težina:8.09537N</p>
<p>Element-31</p> 	<p>Gredni element</p>	<p>Presjek-ISO/cijev/40 x 40 x 4 Površina presjeka: 371612.16mm² Dužina:953.812mm Volumen:0.000549392m³ Masena gustoća:2700kg/m³ Masa:1.48336kg Težina:14.5369N</p>
<p>Element-32</p> 	<p>Gredni element</p>	<p>Presjek-ISO/cijev/40 x 40 x 4 Površina presjeka: 371612.16mm² Dužina:1154.7mm Volumen:0.000665107m³ Masena gustoća:2700kg/m³ Masa:1.79579kg Težina:17.5987N</p>
<p>Element-33</p> 	<p>Gredni element</p>	<p>Presjek-ISO/cijev/40 x 40 x 4 Površina presjeka: 371612.16mm² Dužina:960mm Volumen:0.00055296m³ Masena gustoća:2700kg/m³ Masa:1.49299kg Težina:14.6313N</p>
<p>Element-34</p> 	<p>Gredni element</p>	<p>Presjek-ISO/cijev/40 x 40 x 4 Površina presjeka: 371612.16mm² Dužina:260mm Volumen:0.00014976m³ Masena gustoća:2700kg/m³ Masa:0.404352kg Težina:3.96265N</p>

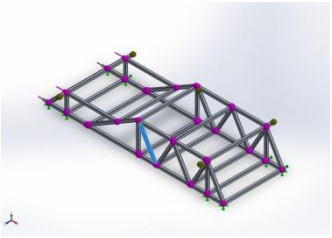
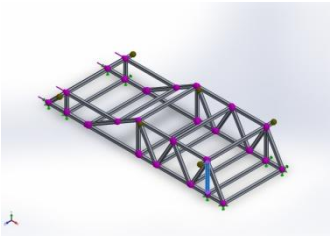
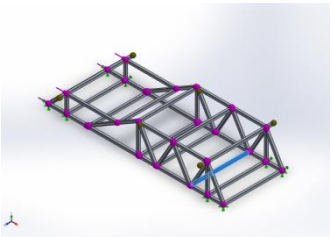
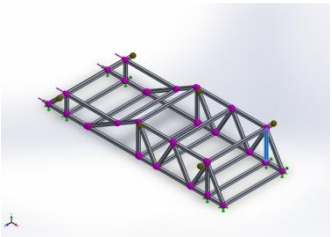
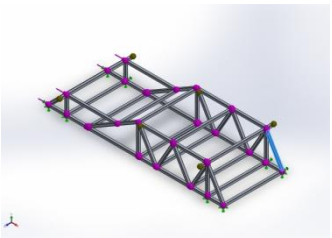
<p>Element-35</p> 	<p>Gredni element</p>	<p>Presjek-ISO/cijev/40 x 40 x 4 Površina presjeka: 371612.16mm² Dužina:513.608mm Volumen:0.00029703m³ Masena gustoća:2700kg/m³ Masa:0.801982kg Težina:7.85942N</p>
<p>Element-36</p> 	<p>Gredni element</p>	<p>Presjek-ISO/cijev/40 x 40 x 4 Površina presjeka: 371612.16mm² Dužina:460mm Volumen:0.00026496m³ Masena gustoća:2700kg/m³ Masa:0.715392kg Težina:7.01084N</p>
<p>Element-37</p> 	<p>Gredni element</p>	<p>Presjek-ISO/cijev/40 x 40 x 4 Površina presjeka: 371612.16mm² Dužina:960mm Volumen:0.00055296m³ Masena gustoća:2700kg/m³ Masa:1.49299kg Težina:14.6313N</p>
<p>Element-38</p> 	<p>Gredni element</p>	<p>Presjek-ISO/cijev/40 x 40 x 4 Površina presjeka: 371612.16mm² Dužina:460mm Volumen:0.00026496m³ Masena gustoća:2700kg/m³ Masa:0.715392kg Težina:7.01084N</p>
<p>Element-39</p> 	<p>Gredni element</p>	<p>Presjek-ISO/cijev/40 x 40 x 4 Površina presjeka: 371612.16mm² Dužina:488.368mm Volumen:0.000282617m³ Masena gustoća:2700kg/m³ Masa:0.763066kg Težina:7.47805N</p>

Mjerne jedinice

Mjerni sustav:	SI (MKS)
Dužina/Pomak	mm
Temperatura	K
Kutno ubrzanje	Rad/sec
Naprezanje	N/m ²

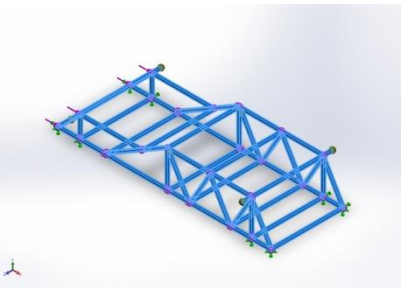

Karakteristike materijala

Model	Karakteristike	Komponente
	<p>Ime: 1060 Aluminijeva legura</p> <p>Yield-ova snaga: 2.75742e+007 N/m²</p> <p>Vlačna gvrstoća: 6.89356e+007 N/m²</p> <p>Modul elastičnosti: 6.9e+010 N/m²</p> <p>Poisson'ov koeficijent: 0.33</p> <p>Masena gustoća: 2700 kg/m³</p> <p>Modul smicanja: 2.7e+010 N/m²</p> <p>Toplinski koeficijent ekspanzije: 2.4e-005 / Kelvin</p>	<p>Element 1</p> <p>Element 2</p> <p>Element 3</p> <p>Element 4</p> <p>Element 5</p> <p>Element 6</p> <p>Element 7</p> <p>Element 8</p> <p>Element 9</p> <p>Element 10</p> <p>Element 11</p> <p>Element 12</p> <p>Element 13</p> <p>Element 14</p> <p>Element 15</p> <p>Element 16</p> <p>Element 17</p> <p>Element 18</p> <p>Element 19</p> <p>Element 20</p> <p>Element 21</p> <p>Element 22</p> <p>Element 23</p> <p>Element 24</p> <p>Element 25</p> <p>Element 26</p> <p>Element 27</p> <p>Element 28</p> <p>Element 29</p> <p>Element 30</p> <p>Element 31</p> <p>Element 32</p> <p>Element 33</p> <p>Element 34</p> <p>Element 35</p> <p>Element 36</p> <p>Element 37</p> <p>Element 38</p> <p>Element 39</p>

Sile i uklještenja

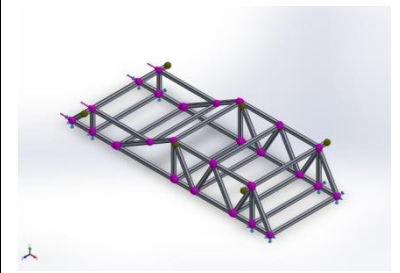
Uklještenja	Slika	Detalji
Uklještenje-1		Količina: U 8 čvorova Tip: Fiksno uklještenje

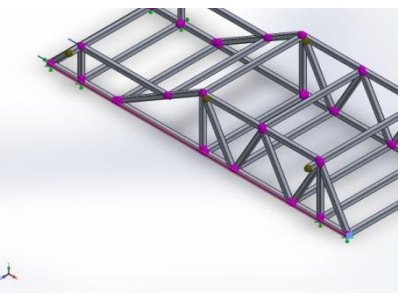
Opterećenje	Slika	Detalji
Sila-1		Količina: U 4 čvora Smjer: U smjeru X- osi Tip: Primjenjena sila Iznos: 4900 N

Mreža

Mreža - Detalji

Ukupni broj čvorova	617
Ukupni broj elemenata	616
Vrijeme potrebno za generiranje mreže(hh:mm:ss):	00:00:11

Model name: Part12bdsbv
Study name: Static 3(-Default<As Machined>-)
Mesh type:

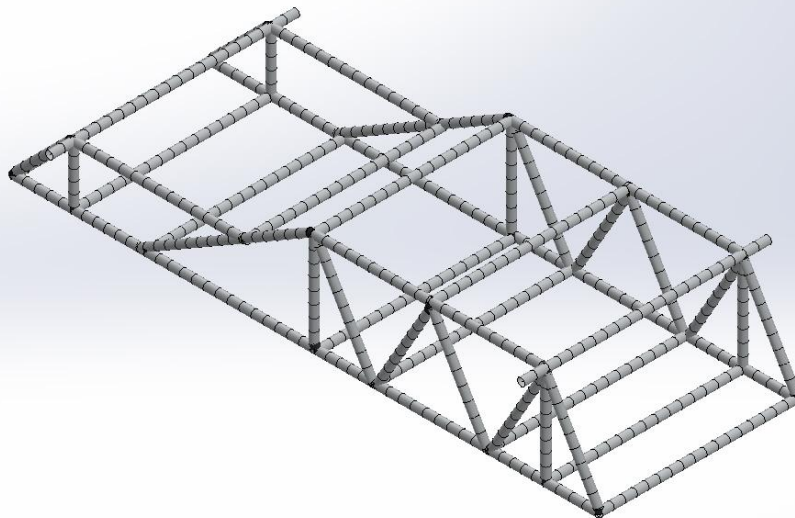

Rezultirajuće vrijednosti

Sila

Područje	Jedinica	Suma po X	Suma po Y	Suma po Z	Rezultirajuća
Model	N	-19600	0.00012207	7.45058e-009	19600

Momenti

Područje	Jedinica	Suma po X	Suma po Y	Suma po Z	Rezultirajući
Model	N.m	0.122079	0.0192421	196.549	196.549

Rezultati

Ime	Tip	Min	Max
Naprezanje	TXY: Smicanje u smjeru Y-osi na YZ ravnini	0 N/m ² Element: 153	1.47288e+007 N/m ² Element: 526

Model name: Part12bdsbv
Study name: Static 3[-Default<As Machined>-]
Plot type: Upper bound axial and bending Stress1
Deformation scale: 1799.06

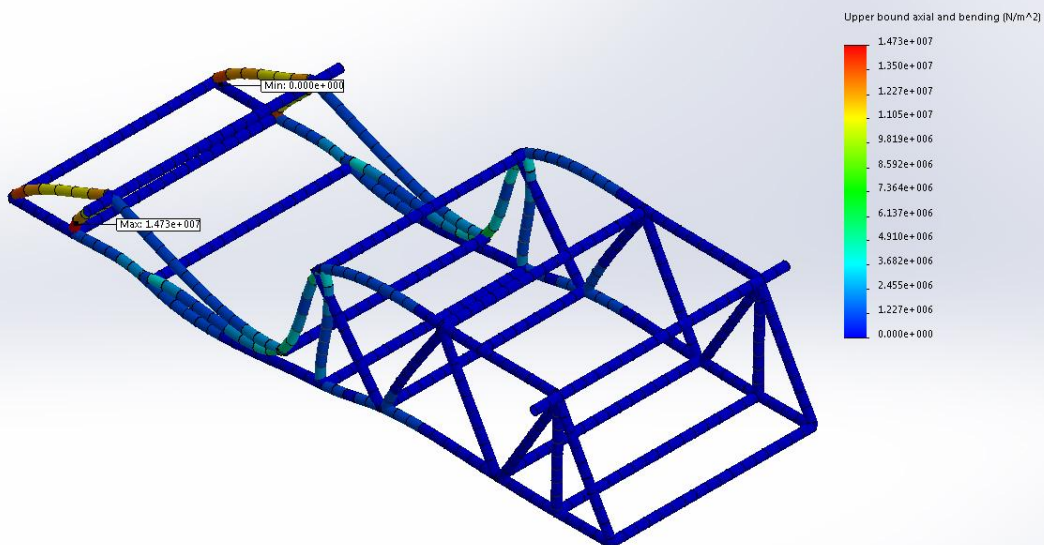

Ime	Tip	Min	Max
Pomaci	UX: Pomaci u smjeru X-osi	-0.0279854 mm Čvor: 115	0.107613 mm Čvor: 1

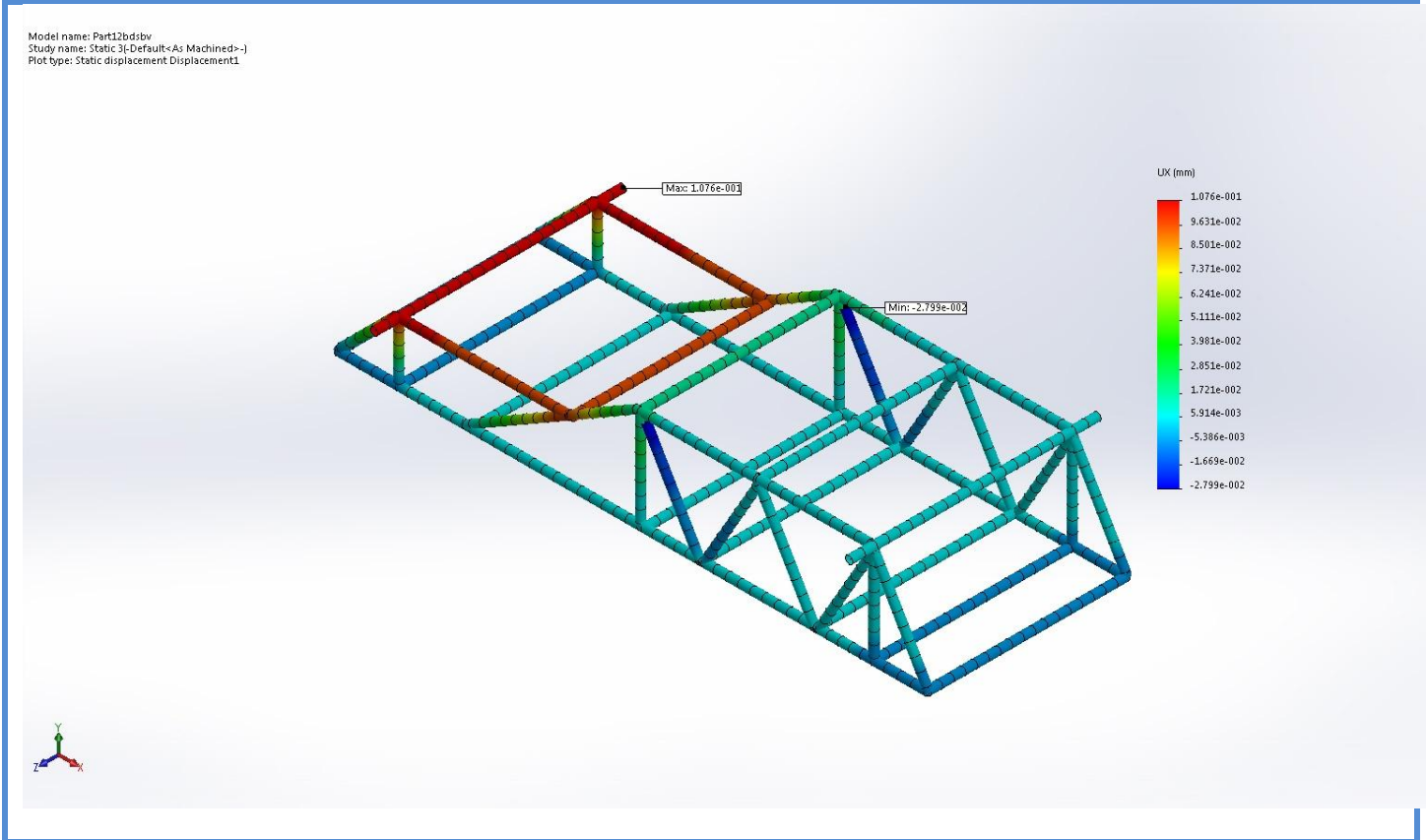

Ime	Tip
Pomaci	Deformiranost oblika

Model name: Part12bdsbv
Study name: Static 3(Default<As Machined>-)
Plot type: Deformed Shape Displacement1[1]
Deformation scale: 1799.06

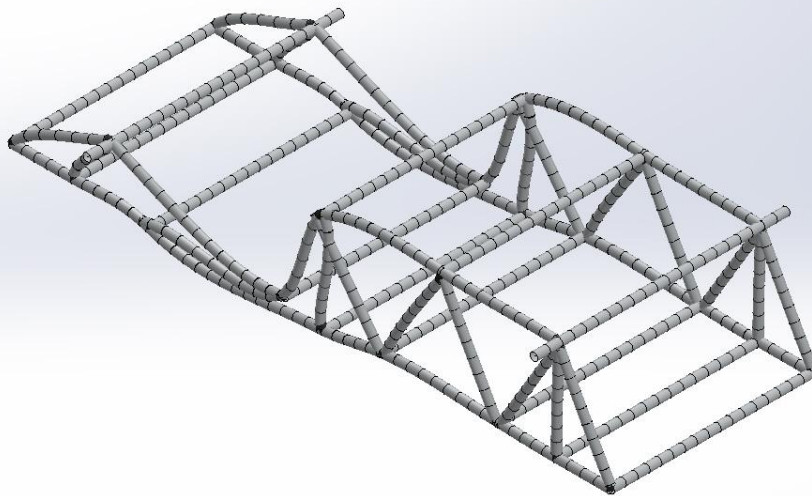

Ime	Tip	Min	Max
Nprezanje	TXY: Smicanje u smjeru Y-osi na YZ ravnini	0 N/m ² Element: 153	1.47288e+007 N/m ² Element: 526

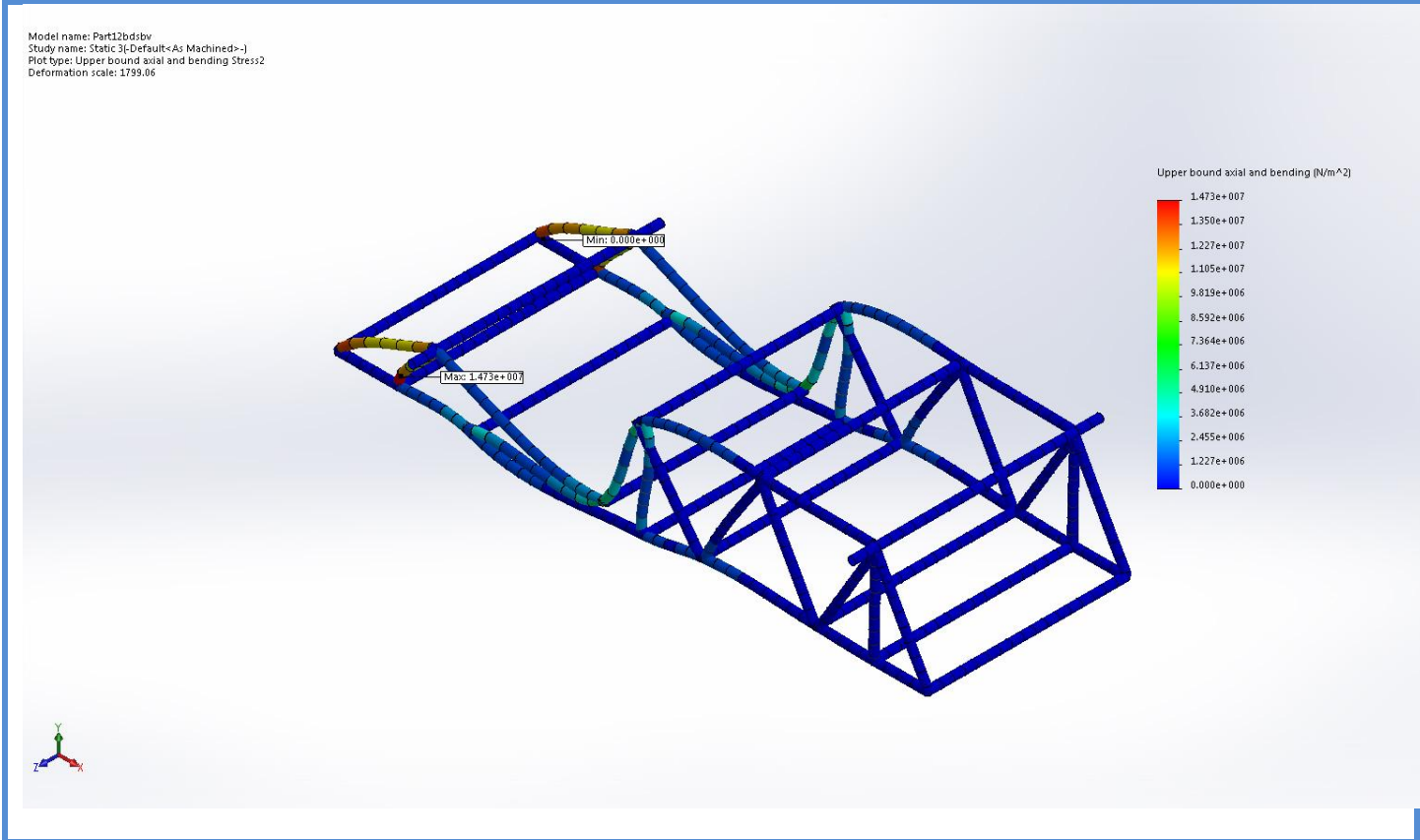

Ime	Tip	Min	Max
Pomaci	UY: Pomaci u smjeru Y-osi	-0.167587 mm Node: 391	0.0162803 mm Node: 63

Model name: Part12bdsbv
Study name: Static 3(Default<As Machined>-)
Plot type: Static displacement Displacement2
Deformation scale: 1799.06

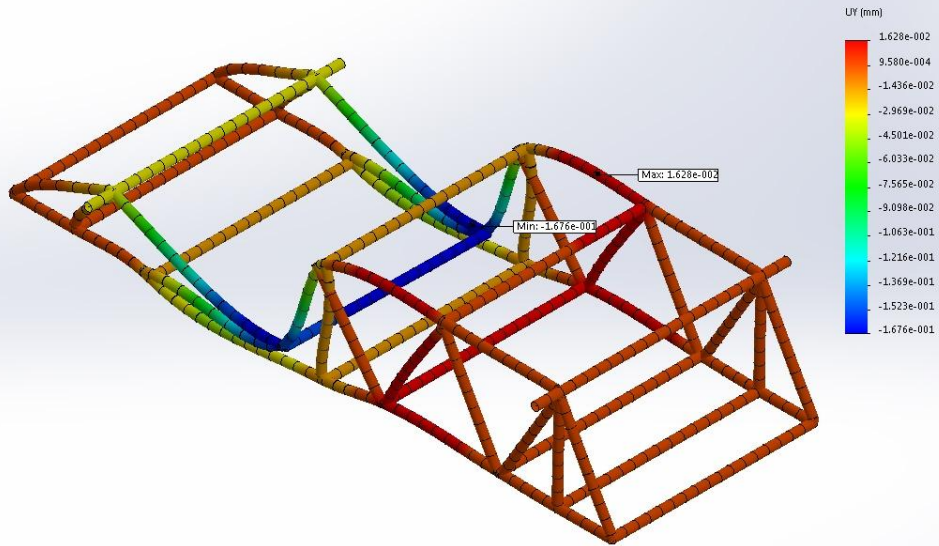

Ime	Tip	Min	Max
Pomaci	RFZ: Z Reakcijska sila	-0.131611 N Čvor: 168	0.183738 N Čvor: 163

Model name: Part12b1d1sv
Study name: Static 3(Default<As Machined>-)
Plot type: Static reaction force Displacement3
Deformation scale: 1799.06

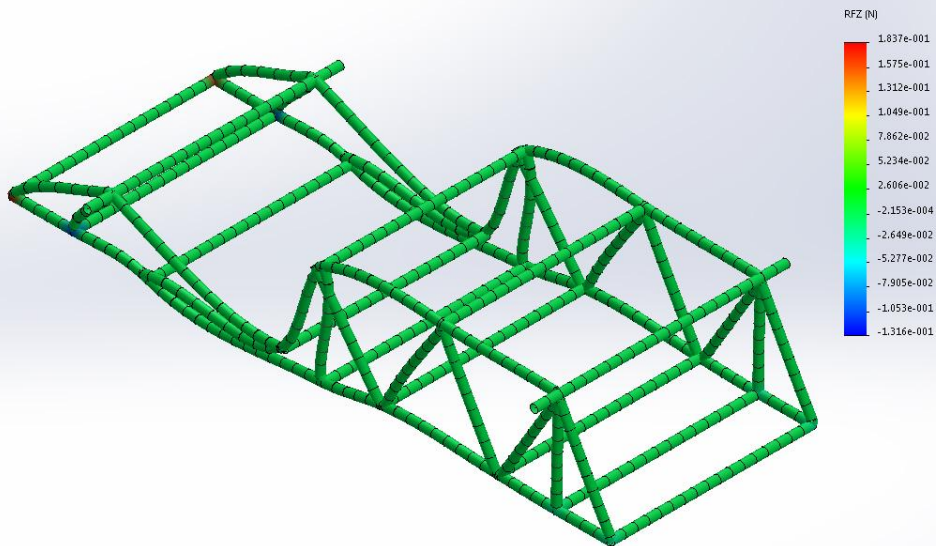

Ime	Tip	Min	Max
Naprezanje	SX:Naprezanje u smjeru X-osi	-7.03686e+006 N/m ² Element: 259	1.00742e+007 N/m ² Element: 22

Model name: Part12bdsbv
Study name: Static 3(-Default<As Machined>-)
Plot type: Axial stress (P/A) Stress3
Deformation scale: 1799.06

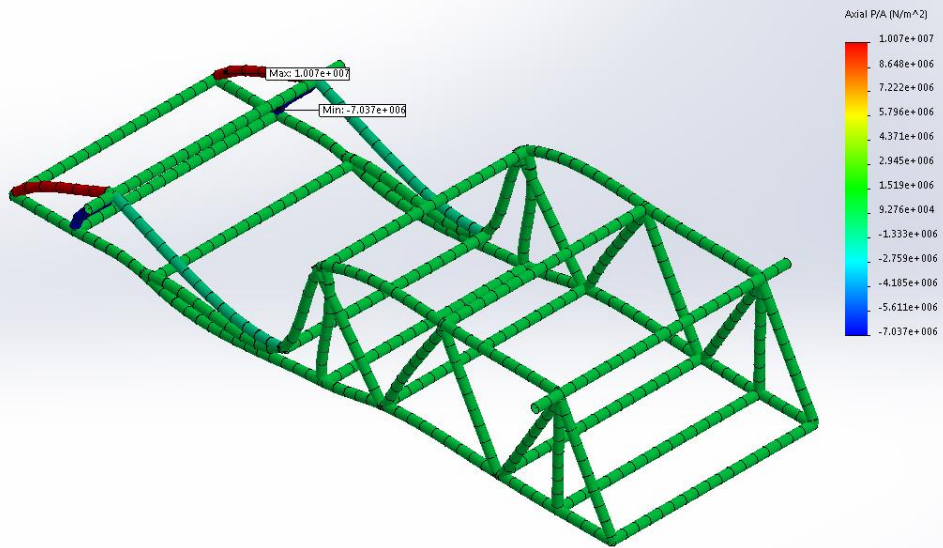

Ime	Tip
Pomaci	RFRES: Rezultanta reakcijska sila

Model name: Part12b.dsbv
Study name: Static 3(-Default<As Machined>-)
Plot type: Static reaction force Displacement2[1]
Deformation scale: 1799.06

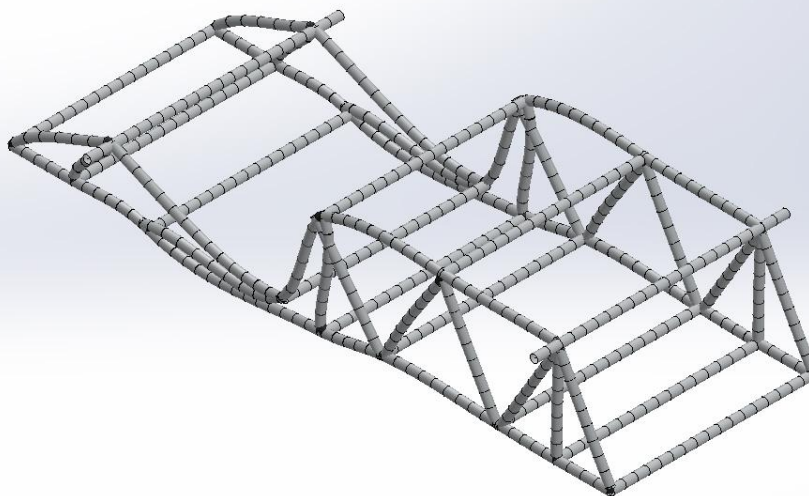

Ime	Tip
Pomak	Deformiranost oblika

Model name: Part12b.dsbv
Study name: Static 3(-Default<As Machined>-)
Plot type: Deformed Shape Displacement3[1]
Deformation scale: 1799.06

