

# Feasibility study of a carbon capture and utilization (CCU) project on the example of the Croatian LNG terminal

---

**Kolovrat, Marko**

**Master's thesis / Diplomski rad**

**2024**

*Degree Grantor / Ustanova koja je dodijelila akademski / stručni stupanj:* **University of Zagreb, Faculty of Mining, Geology and Petroleum Engineering / Sveučilište u Zagrebu, Rudarsko-geološko-naftni fakultet**

*Permanent link / Trajna poveznica:* <https://urn.nsk.hr/urn:nbn:hr:169:066586>

*Rights / Prava:* [In copyright](#) / [Zaštićeno autorskim pravom.](#)

*Download date / Datum preuzimanja:* **2025-01-31**



*Repository / Repozitorij:*

[Faculty of Mining, Geology and Petroleum Engineering Repository, University of Zagreb](#)



UNIVERSITY OF ZAGREB  
FACULTY OF MINING, GEOLOGY AND PETROLEUM ENGINEERING  
Graduate study in Petroleum Engineering

**FEASIBILITY STUDY OF A CARBON CAPTURE AND UTILIZATION (CCU)  
PROJECT ON THE EXAMPLE OF THE CROATIAN LNG TERMINAL**

Master's thesis

Marko Kolovrat

N360

Zagreb, 2024

FEASIBILITY STUDY OF A CARBON CAPTURE AND UTILIZATION (CCU) PROJECT ON THE  
EXAMPLE OF THE CROATIAN LNG TERMINAL

Marko Kolovrat

Thesis completed at: University of Zagreb  
Faculty of Mining, Geology and Petroleum Engineering  
Department of Petroleum and Gas Engineering and Energy  
Pierottijeva 6, 10 000 Zagreb

Abstract

Carbon capture projects are becoming more common around the world. After capture, carbon dioxide can be stored (CCS), utilized (CCU), or both (CCUS). Projects based on carbon capture from flue gases have, so far, largely focused on CCS to hedge the future cost of CO<sub>2</sub> allowances, e.g. in the EU ETS, for the emitter. Some have focused on EOR as a CCUS technology. However, almost none have focused on pure utilization (CCU) of carbon dioxide as a product, even though carbon dioxide is a very important gas for industry and the economy, with numerous applications. Recent turbulences in the supply of CO<sub>2</sub> and the significant rise of CO<sub>2</sub> prices, coupled with the development of innovative products using CO<sub>2</sub> as a feedstock, might provide more opportunity to focus on utilization of the CO<sub>2</sub> in carbon capture projects. This master's thesis presents an example of a feasibility study of a CCU project along with a comprehensive overview of technologies for carbon capture and of many possible uses of carbon dioxide. The feasibility study is provided mainly as a techno-economic analysis with consideration of some legislative aspects of the project. A practical description of functioning of the EU ETS is provided in the introduction. Cases are based on the Croatian LNG terminal as the emitter of carbon dioxide which could potentially install a carbon capture system. Real-world information about functioning of the LNG terminal was provided by LNG Croatia LLC, including flue gas compositions and properties. Carbon dioxide emissions at the LNG terminal result from Wärtsilä generating sets that the plant uses to produce its own electrical energy necessary for the functioning of the terminal. The techno-economic analysis is provided in two separate chapters. The technological analysis is provided through simulation and modelling of an amine carbon capture plant in Aspen HYSYS, while the economic analysis is provided through a detailed explanation of foundational assumptions for the analysis and, then, through calculations of CAPEX, OPEX, NPV, and specific production costs of CO<sub>2</sub> for each case. Three cases are presented and analysed. Settings and results of modelling in HYSYS are provided in extensive detail, in part to also potentially serve any future researchers. Assumptions for the economic analysis are also based on real-world industry sources, which increases the accuracy of the results. Finally, possible future research directions are presented as well.

Keywords: carbon capture and utilization, CCU, feasibility study, LNG terminal, techno-economic analysis, carbon dioxide uses, HYSYS, EU ETS

Thesis contains: 208 pages, 52 tables, 50 figures, and 503 references.

Original in: English

Archived in: Library of Faculty of Mining, Geology and Petroleum Engineering, Pierottijeva 6, Zagreb

Supervisor: Daria Karasalihović Sedlar, PhD, Full Professor

Reviewers: Daria Karasalihović Sedlar, PhD Full Professor  
Domagoj Vulin, PhD, Full Professor  
Luka Perković, PhD, Associate Professor

Defence date: September 30, 2024, Faculty of Mining, Geology and Petroleum Engineering, University of Zagreb

STUDIJA IZVODLJIVOSTI PROJEKTA HVATANJA I KORIŠTENJA UGLJIKA (HKU) NA PRIMJERU  
HRVATSKOG LNG TERMINALA

Marko Kolovrat

Rad izrađen: Sveučilište u Zagrebu  
Rudarsko-geološko-naftni fakultet  
Zavod za naftno-plinsko inženjerstvo i energetiku  
Pierottijeva 6, 10 000 Zagreb

Sažetak

Projekti hvatanja ugljika postaju sve češći u svijetu. Nakon hvatanja, ugljikov dioksid se može skladištiti (CCS), koristiti (CCU) ili oboje (CCUS). Projekti hvatanja ugljika iz dimnih plinova su se, dosad, uglavnom usredotočivali na CCS radi hedžiranja budućeg troška emisijskih dozvola, npr. u EU ETS-u, za emitera. Neki su se usredotočili na EOR kao CCUS tehnologiju. Međutim, gotovo nijedni se nisu usredotočili na čisto korištenje (CCU) ugljikovog dioksida kao proizvoda, iako je ugljikov dioksid vrlo važan plin za industriju i gospodarstvo, s mnogobrojnim primjenama. Nedavne turbulencije u dobavi CO<sub>2</sub> i značajan rast cijena CO<sub>2</sub>, zajedno s razvojem inovativnih proizvoda koji koriste CO<sub>2</sub> kao sirovinu, mogli bi pružiti više prilika za usredotočivanje na upotrebu CO<sub>2</sub> u projektima hvatanja ugljika. Ovaj diplomski rad predstavlja primjer studije izvodljivosti CCU projekta zajedno s opsežnim pregledom tehnologija za hvatanje ugljika i mnogih mogućih upotreba ugljikovog dioksida. Studija izvodljivosti je dana primarno kao tehno-ekonomska analiza s razmatranjem nekih pravnih aspekata projekta. Praktičan opis funkcioniranja EU ETS-a je dan u uvodu. Slučajevi se temelje na hrvatskom LNG terminalu kao emiteru ugljikovog dioksida koji bi potencijalno mogao instalirati sustav za hvatanje ugljika. Stvarne informacije o funkcioniranju LNG terminala ustupljene su od strane LNG Hrvatske d.o.o., uključujući sastav i svojstva dimnog plina. Emisije ugljikovog dioksida na LNG terminalu dolaze iz Wärtsilinih motora koji služe za proizvodnju vlastite električne energije potrebne za funkcioniranje terminala. Tehno-ekonomska analiza dana je u dva zasebna poglavlja. Tehnološka analiza je dana kroz simulaciju i modeliranje aminskog postrojenja za hvatanje ugljika u programu Aspen HYSYS, dok je ekonomska analiza dana kroz detaljno objašnjenje temeljnih pretpostavki za analizu te, zatim, kroz izračune CAPEX-a, OPEX-a, NPV-a i specifičnih proizvodnih troškova CO<sub>2</sub> za svaki slučaj. Tri slučaja su predstavljena i analizirana. Postavke i rezultati modeliranja u programu HYSYS dani su s opsežnim detaljima, djelomice zato da bi možda poslužili i nekim budućim istraživačima. Pretpostavke za ekonomsku analizu također se temelje na stvarnim izvorima iz industrije, što povećava točnost rezultata. Zaključno, predstavljeni su i mogući budući smjerovi istraživanja.

Ključne riječi: hvatanje i korištenje ugljika, CCU, studija izvodljivosti, LNG terminal, tehno-ekonomska analiza, upotrebe ugljikovog dioksida, HYSYS, EU ETS

Diplomski rad sadrži: 208 stranica, 52 tablice, 50 slika i 503 reference.

Jezik izvornika: Engleski

Pohrana rada: Knjižnica Rudarsko-geološko-naftnog fakulteta, Pierottijeva 6, Zagreb

Mentorica: Dr. sc. Daria Karasalihović Sedlar, redovita profesorica RGNF

Ocjenjivači: Dr. sc. Daria Karasalihović Sedlar, redovita profesorica RGNF  
Dr. sc. Domagoj Vulin, redoviti profesor RGNF  
Dr. sc. Luka Perković, izvanredni profesor RGNF

Datum obrane: 30. rujna 2024., Rudarsko-geološko-naftni fakultet Sveučilišta u Zagrebu

## ACKNOWLEDGMENTS

I would like to deeply thank my parents, Bojana and Petar, for their continued support throughout my activities and studies. I would also like to thank all my friends, my extended family, and my girlfriend Andrea, for their unwavering support and understanding throughout the entire writing process. I thank Mr. Dario Ferenčaba and Mr. Marko Častek, from LNG Hrvatska d.o.o., for their support and patience throughout the writing process, for providing a lot of useful information, and for a personal tour of the LNG terminal. I thank my mentor, prof. Daria Karasalihović Sedlar, for providing me with this topic and for the opportunity to work on such an interesting, impactful, and current topic, as well as for her patience, support and belief in me. I thank prof. Igor Dejanović, and dr.sc. Goran Lukač, from the Faculty of Chemical Engineering and Technology at the University of Zagreb, for providing me with masterclasses in creating simulations and modelling of the amine carbon capture process in chemical engineering simulation software, as well as advice on conducting the techno-economic analysis. I thank Mr. Sina Orangi, from the University of South-Eastern Norway, for all his advice, which was critical for the improvement of my understanding of process design, and for providing feedback on my models in HYSYS. I thank Ms. Ines Hemetek Potroško, from INA, d.d., for providing advice and contacts regarding process modelling. I thank Mr. Fran Leskovar, Mr. Fran Jazbec, and Mr. Eugen Lovrić, from SCAN d.o.o., on advice regarding process modelling. I thank prof. Luka Perković, from the Faculty of Mining, Geology and Petroleum Engineering at the University of Zagreb, for his advice and explanations regarding heat exchanger design. I thank prof. Domagoj Vulin, from the same faculty, for his advice on details of the carbon capture process and the subject matter in general. I thank Ms. Lucija Jukić, from the same faculty, for her time spent on ensuring compliance of the thesis with technical requirements of the Faculty. I thank Mr. Robert Mikulandrić, from Atlast Copco, for his information on carbon dioxide prices and for useful contacts at gasworld. I thank Ms. Natalie Merrifield and Mr. Matt Titheridge at gasworld for providing me with student access to their publication. I thank Mr. Jonathan Dielacher for his advice on economic analysis. I thank prof. Dalibor Kuhinek, from my faculty, for his direction regarding the international standard on using carbon dioxide for inerting. I thank the dean of my faculty, prof. Vladislav Brkić, other members of faculty, the administrator of the Department of Petroleum and Gas Engineering and Energy, Ms. Ivana Giljanović Subašić, and the security staff for allowing me to use the computer laboratory outside of the usual working hours to work on simulations. I thank the Information

Technology Support Centre at my faculty, as well as faculty members Ms. Katarina Žbulj and prof. Katarina Simon, for providing support with the functioning of HYSYS. I thank anyone who has uploaded their tutorials on topics regarding HYSYS to YouTube or elsewhere onto the internet. I thank everyone at Aspen Technology, Inc., for creating and maintaining HYSYS, the chemical engineering simulation software used in this thesis. I thank all the professors and assistants who helped me learn throughout my studies. I thank anyone else who has helped me throughout the writing process in general.

I also thank all the engineers, and scientists, whose research in chemical engineering, mechanical engineering, petroleum engineering, electrical engineering, physics, chemistry, economics, etc. enabled me to gather all the necessary information and write this thesis. My work would not have been possible without them. Therefore, in the words of Sir Isaac Newton, I truly stand on the shoulders of giants.

## CONTENTS

<b>LIST OF FIGURES.....</b>	<b>I</b>
<b>LIST OF TABLES.....</b>	<b>III</b>
<b>LIST OF USED SYMBOLS AND UNITS .....</b>	<b>V</b>
<b>LIST OF ABBREVIATIONS .....</b>	<b>VII</b>
<b>1. INTRODUCTION.....</b>	<b>1</b>
<b>2. CARBON DIOXIDE EMISSIONS REDUCTION TECHNOLOGIES.....</b>	<b>11</b>
<b>2.1. Pre-combustion capture .....</b>	<b>11</b>
2.1.1. Partial oxidation .....	13
2.1.2. Gasification .....	14
2.1.3. Steam methane reforming .....	14
<b>2.2. Post-combustion capture.....</b>	<b>15</b>
2.2.1. Chemical reactions in the absorption of carbon dioxide with MEA.....	18
2.2.1.1. <i>The zwitterion theory.....</i>	<i>18</i>
2.2.1.2. <i>The termolecular theory .....</i>	<i>20</i>
2.2.1.3. <i>Carbamic acid theory.....</i>	<i>22</i>
2.2.2. Process equipment .....	23
2.2.2.1. <i>General process diagram .....</i>	<i>24</i>
2.2.2.2. <i>Equipment.....</i>	<i>27</i>
2.2.3. Process parameters.....	42
2.2.3.1. <i>Loading capacity .....</i>	<i>42</i>
2.2.3.2. <i>Absorption capacity.....</i>	<i>43</i>
2.2.3.3. <i>Cyclic loading.....</i>	<i>43</i>
2.2.3.4. <i>Cyclic capacity .....</i>	<i>44</i>
2.2.3.5. <i>Reboiler duty and regeneration energy.....</i>	<i>45</i>
<b>2.3. Oxyfuel combustion .....</b>	<b>47</b>
<b>2.4. Other technologies .....</b>	<b>48</b>
<b>3. POSSIBLE UTILIZATIONS OF THE CAPTURED CO<sub>2</sub>.....</b>	<b>49</b>
<b>3.1. Potential cost and economic benefit of carbon capture and storage (CCS) .....</b>	<b>50</b>
<b>3.2. Utilizations in the oil and gas industry: EOR, EGR, and gas lift.....</b>	<b>54</b>
3.2.1. EOR .....	54
3.2.1.1. <i>Sources of carbon dioxide .....</i>	<i>55</i>
3.2.2. EGR .....	55

3.2.3.	Gas lift.....	55
<b>3.3.</b>	<b>Direct (“non-conversion”) utilizations of carbon dioxide .....</b>	<b>56</b>
<b>3.4.</b>	<b>Indirect (“conversion”) utilizations of carbon dioxide.....</b>	<b>59</b>
3.4.1.	Mineral carbonation .....	59
3.4.2.	Chemicals, fertilizers, plastics, and polymers.....	60
3.4.3.	Fuels and e-fuels .....	62
3.4.4.	Geothermal energy and energy storage.....	63
<b>4.</b>	<b>MODELING POST-COMBUSTION CAPTURE OF CO<sub>2</sub> IN ASPEN HYSYS..</b>	<b>64</b>
<b>4.1.</b>	<b>Flue gas compositions and physical properties .....</b>	<b>64</b>
<b>4.2.</b>	<b>Modelling and simulation.....</b>	<b>74</b>
<b>4.3.</b>	<b>First case – MEA 30% concentration .....</b>	<b>80</b>
<b>4.4.</b>	<b>Second case – MEA 30% conc. with 3.83 MJ/kgCO<sub>2</sub>.....</b>	<b>100</b>
<b>4.5.</b>	<b>Third case – MEA 40% conc. with 99% capture efficiency and 99% product purity</b>	<b>112</b>
<b>5.</b>	<b>ECONOMICS OF THE PROJECT .....</b>	<b>117</b>
<b>5.1.</b>	<b>Foundational assumptions for the economic analysis .....</b>	<b>117</b>
5.1.1.	Capital expenditures (CAPEX) and operating expenditures (OPEX) .....	117
5.1.2.	The discount rate.....	119
5.1.3.	Maintenance costs.....	119
5.1.4.	Time of plant operation.....	119
5.1.5.	The price of electricity .....	120
5.1.6.	The price of MEA .....	121
5.1.7.	The price of process water .....	122
5.1.8.	The price of steam.....	123
5.1.9.	Removal of NO <sub>x</sub> and PM .....	126
5.1.10.	Final purification.....	127
5.1.11.	Storage and transportation .....	127
5.1.12.	The price of carbon dioxide .....	128
5.1.12.1.	<i>Supply issues.....</i>	<i>128</i>
5.1.12.2.	<i>Prices.....</i>	<i>131</i>
<b>5.2.</b>	<b>First case – MEA 30%.....</b>	<b>136</b>
<b>5.3.</b>	<b>Second case – MEA 30% and 3.83 MJ/kgCO<sub>2</sub> regeneration energy .....</b>	<b>143</b>
<b>5.4.</b>	<b>Third case – MEA 40% with 99% capture efficiency and 99% product purity</b>	<b>148</b>



<b>6. FURTHER STUDY CONSIDERATIONS .....</b>	<b>152</b>
<b>7. CONCLUSION.....</b>	<b>154</b>
<b>8. REFERENCES .....</b>	<b>155</b>

## LIST OF FIGURES

Figure 1-1 The Croatian LNG terminal .....	2
Figure 1-2 The LNG terminal (left) with ship's funnels visible .....	2
Figure 1-3 Three funnels of the FSRU (original work).....	3
Figure 1-4 The three Wärtsilä 12V34DF gensets in the engine room of the LNG terminal .	3
Figure 1-5 The three Wärtsilä 12V34DF gensets in the engine room of the LNG terminal, side view .....	4
Figure 1-6 Wärtsilä 12V34DF genset front.....	4
Figure 1-7 Wärtsilä 12V34DF engine back.....	5
Figure 2-1 General diagram of the amine carbon capture process .....	24
Figure 2-2 Tray absorption column with bubble caps and triethylene glycol (TEG) as the absorbent for natural gas dehydration .....	28
Figure 2-3 Illustration of flows on a bubble cap tray .....	28
Figure 2-4 Illustration of flows on a bubble cap tray with bubbles.....	29
Figure 2-5 Illustration of a bubble cap on a tray from the column internals menu in HYSYS .....	29
Figure 2-6 A tray with bubble caps .....	30
Figure 2-7 A stack of sieve trays of an absorption column.....	30
Figure 2-8 Illustration of operation of a sieve tray absorption column.....	31
Figure 2-9 Gauze structured packing and sheet metal structured packing .....	33
Figure 2-10 Absorption tower with structured packing and triethylene glycol (TEG) as the absorbent for natural gas dehydration .....	34
Figure 2-11 TEMA's official illustration of the F shell type of heat exchangers .....	36
Figure 2-12 Kettle type reboiler .....	40
Figure 2-13 Kettle type reboiler .....	40
Figure 2-14 Illustration of cyclic capacity.....	45
Figure 4-1 Unification of the three streams of flue gases.....	70
Figure 4-2 Unification and the pre-treatment process of the flue gas .....	72
Figure 4-3 Phase diagram of Carbon dioxide.....	76
Figure 4-4 Electrostatic precipitator .....	78
Figure 4-5 Aspen HYSYS process flow diagram - first case .....	80
Figure 4-6 Absorber column design window in Aspen HYSYS, “Design” tab.....	82
Figure 4-7 “Internals” tab of the absorber window in Aspen HYSYS.....	83

Figure 4-8 Column hydraulics window for the absorber, with Stage 1 in focus.....	84
Figure 4-9 General settings of the desorber .....	87
Figure 4-10 Internals tab of the stripper settings.....	88
Figure 4-11 Hydraulic plots of the desorber, Stage 1.....	89
Figure 4-12 Hydraulic plots of the desorber, Stage 5.....	89
Figure 4-13 Horizontal separator for water removal (HYSYS settings menu).....	92
Figure 4-14 Horizontal separator for water removal, Parameters tab .....	93
Figure 4-15 Horizontal separator selection .....	93
Figure 4-16 Cooling water pump for the separator .....	94
Figure 4-17 Information in the Performance tab of the heat exchanger.....	97
Figure 4-18 Plot of temperature and heat flow in the Performance tab of the heat exchanger .....	97
Figure 4-19 Column hydraulics window for the absorber, with Stage 1 in focus.....	101
Figure 4-20 Hydraulic plots of the desorber, Stage 1.....	104
Figure 4-21 Hydraulic plots of the desorber, Stage 5.....	104
Figure 4-22 Information in the Performance tab of the heat exchanger.....	109
Figure 4-23 Plot of temperature and heat flow in the Performance tab of the heat exchanger .....	109
Figure 4-24 The process diagram of the third case .....	112
Figure 4-25 Absorber hydraulics window with Stage 14 in focus for the third case .....	113
Figure 4-26 Information in the Performance tab of the heat exchanger.....	114
Figure 4-27 Plot of temperature and heat flow in the Performance tab of the heat exchanger .....	114
Figure 4-28 Stripper hydraulics window with Stage 14 in focus for the third case .....	115
Figure 4-29 Stripper specifications.....	115

## LIST OF TABLES

Table 4-1 Composition of flue gas from Engine 1 (the right engine) under working conditions, 2022 assessment.....	64
Table 4-2 Physical properties of flue gas from Engine 1 (the right engine) under working conditions, 2022 assessment.....	65
Table 4-3 Composition of flue gas from Engine 2 (the centre engine) under working conditions, 2022 assessment.....	65
Table 4-4 Physical properties of flue gas from Engine 2 (the centre engine) under working conditions, 2022 assessment.....	65
Table 4-5 Composition of flue gas from Engine 3 (the left engine) under working conditions, 2022 assessment .....	66
Table 4-6 Physical properties of flue gas from Engine 3 (the left engine) under working conditions, 2022 assessment.....	66
Table 4-7 Stream composition of the flue gas from Engine 1 .....	69
Table 4-8 Stream composition of the flue gas from Engine 2.....	69
Table 4-9 Stream composition of the flue gas from Engine 3.....	69
Table 4-10 Composition of the unified flue gas stream under working conditions (“Main stream”) .....	71
Table 4-11 Physical properties of the unified flue gas stream under working conditions ..	71
Table 4-12 “Lean amine” stream composition .....	81
Table 4-13 “Lean amine” stream physical properties .....	81
Table 4-14 “Clean gas” composition.....	85
Table 4-15 “Clean gas” physical properties .....	85
Table 4-16 “Rich amine” composition .....	86
Table 4-17 “Rich amine” physical properties.....	86
Table 4-18 “Pure CO <sub>2</sub> ” (from desorber) stream composition .....	90
Table 4-19 “Pure CO <sub>2</sub> ” (from desorber) stream physical properties.....	90
Table 4-20 “Dehydrated CO <sub>2</sub> ” stream composition .....	94
Table 4-21 “Dehydrated CO <sub>2</sub> ” stream physical properties.....	94
Table 4-22 “Bottoms product” stream composition .....	96
Table 4-23 “Bottoms product” stream physical properties .....	96
Table 4-24 Electricity duties in the first case .....	98
Table 4-25 Cooling water duties in the first case .....	99

Table 4-26 “Lean amine” stream composition .....	100
Table 4-27 “Lean amine” stream physical properties .....	100
Table 4-28 “Clean gas” composition.....	102
Table 4-29 “Clean gas” physical properties .....	102
Table 4-30 “Rich amine” composition .....	102
Table 4-31 “Rich amine” physical properties.....	103
Table 4-32 “Pure CO2” (from desorber) stream composition.....	105
Table 4-33 “Pure CO2” (from desorber) stream physical properties .....	105
Table 4-34 “Dehydrated CO2” stream composition.....	107
Table 4-35 “Dehydrated CO2” stream physical properties .....	107
Table 4-36 “Bottoms product” stream composition .....	108
Table 4-37 “Bottoms product” stream physical properties .....	108
Table 4-38 Electricity duties in the second case.....	110
Table 4-39 Cooling water duties in the second case .....	111
Table 5-1 Prices of carbon dioxide from GTG plin d.o.o. in 2023 .....	132
Table 5-2 Prices of carbon dioxide from Linde in Switzerland .....	133
Table 5-3 Prices of certain CO2 products .....	135
Table 5-4 Capital expenditures in the first case .....	136
Table 5-5 Yearly operating expenditures in the first case .....	138
Table 5-6 Yearly gross incomes possible for the first case .....	139
Table 5-7 NPV calculation table for the first case.....	140
Table 5-8 Capital expenditures in the second case.....	143
Table 5-9 Yearly operating expenditures in the second case .....	144
Table 5-10 Yearly gross incomes possible for the second case .....	145
Table 5-11 NPV calculation table for the second case.....	146
Table 5-12 Yearly operating expenditures in the third case .....	148
Table 5-13 Yearly gross incomes possible for the third case .....	149

## LIST OF USED SYMBOLS AND UNITS

Symbol	Unit	Description
P	Pa	pressure
L	m	length
$\rho$	kg/m <sup>3</sup>	density
-	mg/m <sup>3</sup>	mass concentration
V	m <sup>3</sup>	volume
J	joule	energy
-	kJ	kilojoule
-	MJ	megajoule
-	GJ	gigajoule
-	TJ	terajoule
-	kW	kilowatt
-	MW	megawatt
-	kW	kilowatt
-	kWh	kilowatt-hour
-	GWh(e)	gigawatt-hour (electric)
-	MW(th)	megawatt (thermal)
$\alpha$	mol/mol	CO <sub>2</sub> loading
HTU	m	height of a transfer unit
HETP	m	height equivalent to a theoretical plate
HHV	kJ/m <sup>3</sup>	higher heating value
HHV	kWh/m <sup>3</sup>	higher heating value
-	t	tonne
-	tonne/TJ	CO <sub>2</sub> emissions factor for natural gas
-	Mt	million tonnes
-	Mtpa	million tonnes per year
-	°C	degrees Celsius
-	%	percentage
-	m <sup>3</sup> /hr	volumetric flow rate
-	kg/hr	mass flow rate

-	kgmole/h	molar flow rate
-	bcm	billion cubic metres
-	Sm <sup>3</sup>	standard cubic metres
-	m <sup>3</sup> /h-m <sup>2</sup>	minimum liquid flow rate per unit area
h	hour	time
hr	hour	time
RNG	m <sup>3</sup>	required natural gas
-	EUR/tonne	euros per tonne
-	EUR/kg	euros per kilogram
-	USD/tonne	United States dollars per tonne
-	EUR/kgCO <sub>2</sub>	euros per kilogram of CO <sub>2</sub>
-	EUR/tCO <sub>2</sub>	euros per tonne of CO <sub>2</sub>
-	CAD/tCO <sub>2</sub>	Canadian dollars per tonne of CO <sub>2</sub>
-	CHF/tonne	Swiss francs per tonne of CO <sub>2</sub>
-	CHF/kg	Swiss francs per kilogram of CO <sub>2</sub>
-	USD/tCO <sub>2</sub>	United States dollars per tonne of CO <sub>2</sub>
-	MJ/kgCO <sub>2</sub>	megajoules per tonne of CO <sub>2</sub>
-	GJ/tCO <sub>2</sub>	gigajoules per tonne of CO <sub>2</sub>
Z	m	height of the column packing
N <sub>OG</sub>	-	number of overall transfer units
H <sub>OG</sub>	m	height of a single transfer unit
HTU	m	height of a single transfer unit
NTU	-	number of transfer units

## **LIST OF ABBREVIATIONS**

AC – Absorption Capacity

ASPEN – Advanced System for Process ENgineering

AspenTech – Aspen Technology, Inc.

ASU – Air separation unit

BAT – Best Available Techniques

CAD – Canadian dollar

CAPEX – Capital expenditures

CAS – Controlled Atmosphere Storage

CATF – Clean Air Task Force

CC – Cyclic capacity

CCS – Carbon capture and storage

CCU – Carbon capture and utilization

CCUS – Carbon capture, utilization, and storage

CEPCI - Chemical Engineering Plant Cost Index

CGA – the Compressed Gases Association of America

CHF – Swiss franc

CHP – Combined Heat and Power

CO<sub>2</sub> – Carbon dioxide

DCC – Direct contact cooler

DEA – Dutch Emissions Authority

DOE – U.S. Department of Energy

EEX – European Energy Exchange

EIGA – European Industrial Gases Association

EOR – Enhanced Oil Recovery

EPA – United States Environmental Protection Agency

ESP – Electrostatic precipitators

ETS – Emissions Trading System of the European Union

EU – European Union

EUR – Euro

FID – Final investment decision

FSRU – Floating storage and regasification unit

GPZ - Opskrba – Gradska plinara Zagreb - Opskrba



GO – Guarantees of origin  
H<sub>2</sub>O – Water  
HHV – Higher heating value  
HRK – Croatian kuna  
IEA – International Energy Agency  
IGCC – Integrated Gasification Combined Cycle  
IISD – International Institute for Sustainable Development  
ILs – Ionic liquids  
ISO – International Organization for Standardization  
LNG – Liquefied natural gas  
MEA – Monoethanolamine  
MINGOR – Ministry of Economy and Sustainable Development  
MINGOR – Ministry of Economy  
MIT – Massachusetts Institute of Technology  
MAP – Modified Atmosphere Packaging and  
MOFs – Metal-organic framework  
N<sub>2</sub> – Nitrogen  
NCBI – National Center for Biotechnology Information  
NETL – National Energy Technology Laboratory  
NIST – National Institute of Standards and Technology  
NOAA – National Oceanic and Atmospheric Administration  
NO<sub>x</sub> – Nitrous oxides  
NPV – Net present value  
O<sub>2</sub> – oxygen  
OG – Official Gazette  
OPEX – Operating expenditures  
PM – Particulate matter  
PPA – Power purchase agreement  
RES – Renewable energy sources  
RGN – Faculty of Mining, Geology and Petroleum Engineering at the University of Zagreb  
SAF – Sustainable Aviation Fuel  
SFE – Supercritical fluid extraction  
SNG – Synthetic natural gas or substitute natural gas  
SO<sub>2</sub> – Sulfur dioxide

SO<sub>x</sub> – Sulfur oxides

TEG – Triethylene glycol

TRL – Technology readiness level

U.S. – United States of America

USA – United States of America

USD – United States dollar

## 1. INTRODUCTION

The Croatian liquefied natural gas (LNG) terminal is a floating storage and regasification unit (FSRU) import terminal with a maximum regasification capacity of 2.9 bcm/y or 338,000 m<sup>3</sup>/hr, although a capacity expansion is underway. The terminal commenced operations on 1<sup>st</sup> January 2021. It is operated by LNG Hrvatska d.o.o. (Eng. *LNG Croatia LLC*) and it is located in the Omišalj municipality on the island of Krk, Republic of Croatia (LNG Hrvatska, 2022c; LNG Hrvatska, 2022b; LNG Hrvatska, 2023c). Figure 1-1 below shows the terminal. The ship was renamed from Golar Viking to LNG Croatia prior to its delivery to Croatia (VesselFinder.com, 2024; BalticShipping.com, 2024; Rivieramm.com, 2020; LNG Prime, 2020).

The terminal is supplied with electricity by three Wärtsilä 12V34DF diesel/LNG gensets (generating sets) (LNG Hrvatska, 2022a), located in the ship's engine room, with each one having 12.5 MW thermal input power (LNG Hrvatska, 2022a) and 5760 kW (5.76 MW) rated power (mechanical output power capacity) (Metroalfa, 2022; Metroalfa, 2020; Wärtsilä, 2022). The engine room is located at the aft (rear side) of the ship. The terminal usually uses Low Sulfur Marine Gas Oil (LSMGO) to start the engines and boil-off LNG to run the engines (LNG Hrvatska, 2022a). During normal operation, only two of the three gensets are operational and one serves as backup. These engines usually operate at 50%, 55%, and 60% capacity. The terminal also uses a diesel engine backup generator on the shore part of the terminal (Perkins K-T350.ADB) with 0.385 MW thermal input power (LNG Hrvatska, 2023a). The terminal also has other backup engines and fuel consumption capacities, but these are not used in routine operation and are, therefore, not considered in this thesis. Naturally, the three engines emit flue gases, which contain carbon dioxide, among other gases.



**Figure 1-1** The Croatian LNG terminal (LNG Hrvatska, 2024)

Figure 1-2 shows the FSRU's funnels on the top left:



**Figure 1-2** The LNG terminal (left) with ship's funnels visible (offshore-energy.biz, 2021)

Figure 1-3 shows the three funnels of the FSRU up-close:



**Figure 1-3** Three funnels of the FSRU (original work)

Figure 1-4 shows the Wärtsilä gensets in the engine room of the FSRU:



**Figure 1-4** The three Wärtsilä 12V34DF gensets in the engine room of the LNG terminal (LNG Hrvatska, 2024)

Figure 1-5 shows the Wärtsilä gensets in the engine room of the FSRU from another angle:



**Figure 1-5** The three Wärtsilä 12V34DF gensets in the engine room of the LNG terminal, side view (LNG Hrvatska, 2024)

Figure 1-6 shows a 3D model of the Wärtsilä 12V34DF genset:

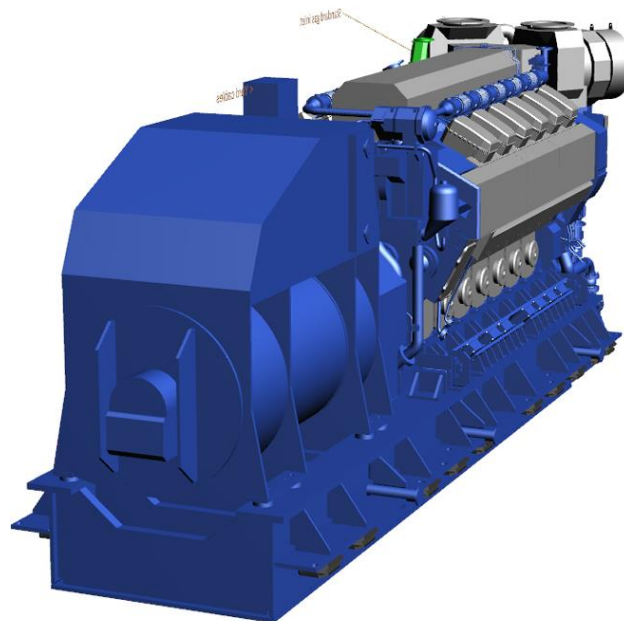

**Figure 1-6** Wärtsilä 12V34DF genset front (Wärtsilä, 2024a)

Figure 1-7 shows a 3D model of the back of a Wärtsilä 12V34DF genset:

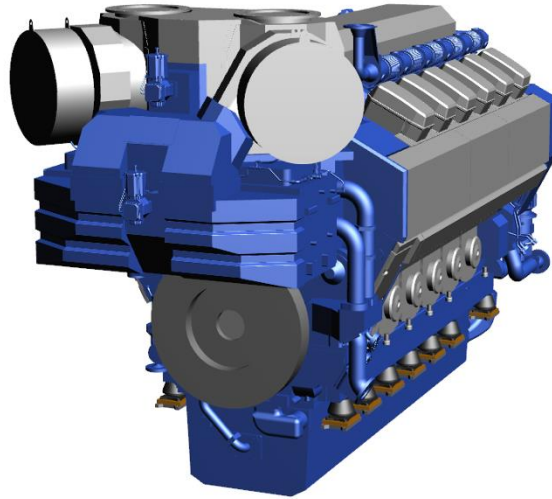

**Figure 1-7** Wärtsilä 12V34DF engine back (Wärtsilä, 2024a)

It can be approximated that, with an average of 55% working capacity and 8760 yearly working hours for two engines, the gensets on the terminal generate 55.5 GWh(e) every year. In 2021, engines on the LNG terminal consumed 19,082,541.96 Sm<sup>3</sup> of natural gas (boil-off LNG) and 699.70 tonnes of LSMGO. 0.95 tonnes of diesel fuel were consumed on the shore part of the terminal. In 2021, the terminal emitted 39,439.77 tonnes of CO<sub>2</sub>, accounting for 3286.648 tonnes of CO<sub>2</sub> emissions per month on average. Of these, 37,222.35 tonnes of CO<sub>2</sub> were the result of natural gas usage, 2214.42 tonnes of CO<sub>2</sub> were the result of LSMGO usage, and 3.01 tonnes of CO<sub>2</sub> were the result of diesel usage at the mainland portion of the terminal (LNG Hrvatska, 2022a).

In 2022, engines on the LNG terminal consumed 18,216,479.96 Sm<sup>3</sup> of natural gas (boil-off LNG) and 213.26 tonnes of LSMGO. 0.79 tonnes of diesel fuel were consumed on the mainland portion of the terminal. In 2022, the terminal emitted 36,210.43 tonnes of CO<sub>2</sub>, accounting for 3017.536 tonnes of CO<sub>2</sub> emissions per month on average. Of these, 35,533.01 tonnes of CO<sub>2</sub> were the result of natural gas usage, 674.93 tonnes of CO<sub>2</sub> were the result of

LSMGO usage, and 2.49 tonnes of CO<sub>2</sub> were the result of diesel usage at the shore part of the terminal (LNG Hrvatska, 2023a).

In 2023, the terminal emitted 38,215 tonnes of CO<sub>2</sub>, accounting for 3184.583 tonnes of CO<sub>2</sub> emissions per month on average. Of these, 37,379.60 tonnes of CO<sub>2</sub> were the result of natural gas usage, 830.40 tonnes of CO<sub>2</sub> were the result of LSMGO usage, and 5 tonnes of CO<sub>2</sub> were the result of diesel usage at the mainland portion of the terminal (LNG Hrvatska, 2024).

LNG Croatia must participate in the European Union Emissions Trading System (EU ETS), since it satisfies criteria from Annex I of the Directive 2003/87/EC of the European Parliament and of the Council of 13 October 2003 establishing a system for greenhouse gas emission allowance trading within the Union and amending Council Directive 96/61/EC (Official Journal of the European Union [OJ], Series L 275, 25.10.2003). The Annex I criteria is transposed into Croatian national legislation through the Regulation on trading greenhouse gas emission allowances (Official Gazette [OG] 89/20) (Cro. *Uredba o načinu trgovanja emisijskim jedinicama stakleničkih plinova (NN 89/20)*). The criteria is also found in Annex I of the aforementioned Regulation. In particular, LNG Croatia satisfies the criteria because it conducts the following activity from Annex I: “*Combustion of fuels in installations with a total rated thermal input exceeding 20 MW*”. Since the sum of rated thermal inputs of all technical units of the installation is larger than 20 MW, LNG Croatia must participate in the EU ETS.

Participation in the EU ETS means LNG Croatia has to purchase greenhouse gas emission allowances (also known as “carbon allowances”, “CO<sub>2</sub> allowances”, “emission allowances”, etc.) at auctions held throughout the year on the European Energy Exchange (EEX) platform (European Commission, 2021a; European Commission, 2020a; Hedgeweek, 2020; European Energy Exchange [EEX], 2024). Each Member State has a designated auctioneer, which is appointed to sell allowances on the EEX platform on behalf of the Member State to operators located in the Member State (European Commission, 2021a; Ministry of



Economy and Sustainable Development [MINGOR], 2022; EEX, 2023; European Commission, 2023). According to the Decision on the Auctioneer for conducting the auction of allowances and the choice of auction system (Official Gazette 84/14), the designated auctioneer (Cro. *dražbovatelj*) for Croatia is the Environmental Protection and Energy Efficiency Fund (Cro. *Fond za zaštitu okoliša i energetske učinkovitost*, FZOEU) (MINGOR, 2022; SeeNews, 2014; Government of the Republic of Croatia, 2022; European Commission, 2020b). One emission allowance is valid for one tonne of carbon dioxide equivalent emissions, as stipulated by definition (a) in Article 3 of the Directive 2003/87/EC, during the period specified in Article 13 of the Directive 2003/87/EC (OJ, Series L 275, 25.10.2003). Allowances are sold in lots containing 500 allowances (EEX, 2024; OJ, Series L 2023/2830, 20.12.2023). At the end of the calendar year, the plant operator must surrender back the allowances in the amount of yearly verified emissions of the plant (Wikborg Rein, 2023; European Commission, 2021b; Dutch Emissions Authority [DEA], 2023b; DEA, 2023a). The operator can also trade emission allowances with other market participants throughout the year (European Commission, 2021b; European Commission, n.d.; DEA, 2023c). If the operator has any extra allowances remaining at the end of the year, it can keep the allowances for next year or sell them (European Commission, 2021b; European Commission, n.d.; DEA, 2023c). The ability to sell allowances is also beneficial in case the operator permanently reduces plant emissions by implementing an emissions-reduction technology, since the cost of the investment could be partially offset by the sold allowances. Moreover, if the operator manages to reduce CO<sub>2</sub> emissions enough to exit the EU ETS, the operator can sell all of its carbon allowances. Exit from the EU ETS is possible under criteria laid out in Article 27 and 27a of the Directive 2003/87/EC (OJ, Series L 275, 25.10.2003). In transposed Croatian national legislation, exit from the EU ETS is possible according to Article 39 and Article 40 of the Act on Climate Change and Ozone Layer Protection (Official Gazette 127/19) and Article 11 and Article 12 of the Regulation on trading greenhouse gas emission allowances. It should be noted that plant operators might still need to pay an “equivalent contribution” towards achieving emission reductions, despite the exit of the installation from the EU ETS, as stipulated by the same articles. What is more, the activity

of capturing greenhouse gases (from installations covered by the Directive 2003/87/EC and for the purpose of transport and geological storage) also falls under the Annex I criteria, probably because carbon capture plants can also emit carbon dioxide (e.g. through burning fuel for the solvent regeneration process). This particularity is going to be discussed further in the chapters containing the techno-economic analysis of the project. Activities of transporting greenhouse gases for geological storage, and geological storage of greenhouse gases, also fall under the Annex I criteria.

Per Annex I criteria, CO<sub>2</sub> emissions from engines with less than 3 MW rated thermal input are not counted towards the CO<sub>2</sub> emissions of the plant and do not require the purchase of CO<sub>2</sub> emission allowances. Therefore, CO<sub>2</sub> emissions from the Perkins diesel engine are not included in the purchase of allowances for LNG Croatia. CO<sub>2</sub> emissions of LNG Croatia can be publicly viewed in the Environmental Pollution Register (Cro. *Registar onečišćavanja okoliša*, ROO) of Croatia. Verified CO<sub>2</sub> emissions, free allocation of allowances, and compliance with the EU ETS for LNG Croatia, and all other participants of the EU ETS, can be viewed in the European Union Transaction Log, hosted on the website of the Directorate-General for Climate Action of the EU Commission (European Commission, 2024b; Ministry of Economy, 2024).

In 2021, LNG Croatia spent 1,138,376.29 EUR on CO<sub>2</sub> emission allowances. In 2022, LNG Croatia spent 2,920,371.23 EUR on CO<sub>2</sub> emission allowances (LNG Hrvatska, 2022a; LNG Hrvatska, 2023a). In 2023, LNG Croatia spent 3,278,848.04 EUR on CO<sub>2</sub> emission allowances (LNG Hrvatska, 2024). In the first year, the cost of allowances was significantly lower, since a company is obligated to start participating in the EU ETS only when the “greenhouse gas emissions permit” (GHG permit) of the company, issued by the competent national ministry, comes into effect (LNG Hrvatska, 2024). Obviously, this is a large operating cost, which the company would like to reduce. Therefore, the goal of this master’s thesis is to determine whether it could be technically, and economically, feasible to lower carbon dioxide emissions of the Croatian LNG terminal or not.

In particular, this is going to be determined by simulating and modelling the most conventional method for capture of CO<sub>2</sub> emissions currently, the amine chemical absorption process. 30% and 40% solution concentrations of monoethanolamine (MEA) are going to be used. MEA is the most common amine used for carbon capture (Chai et al., 2022; Huang et al., 2019). Simulation and modelling are going to be conducted in Aspen HYSYS V12.1.

Aspen HYSYS is an industry standard for chemical and process engineering simulations in the oil and gas industry and it includes the necessary unit operations, as well as chemical reactions and packages of thermodynamic models, required to simulate carbon dioxide capture from flue gases. As an impurity, carbon dioxide is commonly removed from produced natural gas at natural gas processing plants, which is a process that can be simulated in Aspen HYSYS. Therefore, the ability to simulate CO<sub>2</sub> removal from flue gases is a natural extension of the functionality of HYSYS. The Faculty of Mining, Geology and Petroleum Engineering (RGN Faculty) at the University of Zagreb possesses a licence for usage of HYSYS, which makes HYSYS the most convenient software choice for this thesis. Aspen Technology Inc. (also known as AspenTech) offers an entire software suite aimed at chemical engineering applications, where Aspen Plus is another, even more detailed and more advanced, piece of software with a wider range of chemical industry applications (Abdullah, 2023; ChemEngGuy, n.d.-a; Costa, 2021), although capabilities of Aspen Plus exceed the requirements of this thesis.

Interestingly, a Croatian chemical engineer, Dr. Vladimir Mahalec, participated in creation of the original ASPEN (Advanced System for Process ENgineering) process simulator, while ASPEN was being developed at the Massachusetts Institute of Technology (MIT) from 1976 to 1981 (Evans et al., 1979; Hrv. teh. enckl (Hrvatska tehnička enciklopedija, 2022; Massachusetts Institute of Technology, 1982). Dr. Mahalec was a Postdoctoral Associate at MIT after his diploma at the Faculty of Chemical Engineering, University of Zagreb and his PhD at the University of Texas (McMaster University, 2023a; McMaster University, 2023b). ASPEN was developed as an open source computer program with a grant from the US Department of Energy “*for use in engineering of fossil energy*

*conversion processes*” in response to the 1970s energy crisis (Evans et al., 1979; Aspen Technology Inc, 2023), although the technology was subsequently commercialized with the founding of AspenTech in 1981 (Aspen Technology Inc, 2007; Aspen Technology Inc, 2008) and the release of Aspen Plus in 1982 (Aspen Technology Inc, 2023). Later, Dr. Mahalec also served as the Senior Vice President of Technology at Aspen Technology Inc. for 15 years, from 1991 to 2006 (McMaster University, 2023a), and he is now a professor at McMaster University in Canada (McMaster University, 2023b).

After satisfying technical parameters have been reached through modelling of the process, the process is going to be economically evaluated using some simple economic indicators, like CAPEX, OPEX, NPV, the breakeven price of CO<sub>2</sub>, the cost of capture per tonne of CO<sub>2</sub>, etc., completing the techno-economic assessment. Possible uses of CO<sub>2</sub> are also presented in the thesis.

## **2. CARBON DIOXIDE EMISSIONS REDUCTION TECHNOLOGIES**

Naturally, the first step to reduction of carbon dioxide emissions is to evaluate whether a change of the industrial process is technologically possible, and economically feasible, in a way which would reduce CO<sub>2</sub> emissions of the process or not. In the case of the Croatian LNG terminal, it is currently not possible to change the electricity supply process of the entire terminal. Such an undertaking would involve contracting a power supply, upgrading the electrical system of the LNG terminal, probably reinforcing the local electrical grid for the needs of the LNG terminal, as well as possibly buying guarantees of origin (GO) as a measure of corporate social responsibility. If GOs would not be bought, a power supply could be contracted through a power purchase agreement (PPA) from a producer of electricity from renewable energy sources (RES) as a measure of corporate social responsibility. Indeed, a power supply should be contracted as a part of the expansion of the terminal's regasification capacity in the near future (LNG Hrvatska, 2023c), in order to supply a part of the terminal with electricity from the grid, but such considerations are beyond the scope of this master's thesis.

Therefore, the next step in the process is to evaluate the possibility of usage of carbon dioxide capture technologies. Generally, there are three main types of carbon capture technologies in the sense of placement of capture in the combustion process: pre-combustion capture, post-combustion capture, and oxyfuel combustion. A short overview of the three technologies is given below. A few other technologies are also briefly mentioned.

### **2.1. Pre-combustion capture**

Pre-combustion carbon capture is a technology which involves capturing the potential carbon dioxide emissions before combusting the fuel. This necessarily implies a chemical change of the fuel to another combustible substance and carbon dioxide. The carbon dioxide is then separated from the mixture containing the new combustible substance and CO<sub>2</sub> (Z. Chen, 2022; Jansen et al., 2015; Bagnato and Sanna, 2018). Of course, the new combustible substance should not produce carbon dioxide by combustion. Specifically, hydrocarbon

fuels, such as coal, methane, heavy fuel oil, etc., or biomass, can be transformed by procedures, such as partial oxidation, gasification, or steam methane reforming, into synthesis gas (syngas) (Speight, 2020; Jansen et al., 2015; Z. Chen, 2022; Z. Wu et al., 2023; Reimert et al., 2011). Syngas is a mixture of hydrogen and carbon monoxide in various ratios, with some impurities often present (Speight, 2020; Reimert et al., 2011). Synthesis gas is commonly used in synthesis of various chemical compounds, most often ammonia and methanol (Elliott, 2004; Standen and Killheffer, 2024; da Rosa and Ordóñez, 2022; Hiller et al., 2011). Syngas is combustible and can be directly used as a fuel (Whitty, 2008), although, in the energy industry, it is more common to further transform the carbon monoxide from the syngas mixture into hydrogen and carbon dioxide by using the water-gas shift reaction (da Rosa and Ordóñez, 2022; Hiller et al., 2011). The carbon dioxide is separated from the resulting mixture, while hydrogen is ultimately used as the combustible fuel (Jansen et al., 2015). Combustion of hydrogen in a mixture with air produces mainly water vapour (Pal et al., 2022; A. C. Lewis, 2021; U.S. Department of Energy [DOE], n.d.-a; Lauermann et al., 2013). The carbon dioxide is more easily separated from the resulting mixture with hydrogen, in comparison to separation from post-combustion flue gas mixtures, owing to the greater concentration of carbon dioxide in the mixture and a greater pressure of the mixture (therefore, a greater partial pressure of CO<sub>2</sub> as well) (Jansen et al., 2015; Y. Zhu and Frey, 2010; Rao, 2010; Z. Wang, 2018; Ochoa Robles et al., 2018; DOE, n.d.-b). Captured CO<sub>2</sub> can be further purified and used as a raw material in industrial processes (Samipour et al., 2020), many of which are covered in the chapter on possible utilizations of carbon dioxide. A common example of pre-combustion capture usage are Integrated Gasification Combined Cycle (IGCC) power plants (Jansen et al., 2015; Bagnato and Sanna, 2018; Majić, 2017). The necessity of implementation of many new chemical reactions and unit operations makes pre-combustion capture of carbon dioxide very difficult and expensive to retrofit onto existing power plants (Bandilla, 2020; Blagec, 2023; Y. Lu et al., 2020).

### 2.1.1. Partial oxidation

Partial oxidation is an industrial chemical process in which a substance reacts with a sub-stoichiometric concentration of air (oxygen) in the system, in the presence of high temperature (Speight, 2020; Reimert et al., 2011; Makaryan et al., 2023; SFC Energy, 2021; Google Patents, 2001). In industrial applications, high pressure can also be used (Speight, 2020; Jansen et al., 2015; Reimert et al., 2011). Incomplete combustion is a more general chemical process, where a substance reacts with a sub-stoichiometric concentration of oxygen, but which does not always require high temperature or pressure to occur, in comparison with partial oxidation.

In a sub-stoichiometric mixture, the combustible substance (usually a hydrocarbon substance) is not going to be completely oxidized, since there is not enough air (oxygen) for the reaction to mainly result in the products of a stoichiometric mixture oxidation (or combustion), which are not further flammable (Kardum, 2014; Pavlović, 2021; Čulina, 2016) and usually contain more oxygen atoms per product molecule, as shown by Dragobratović and Holenda (2018), Pavlović (2021), Cvrtila (n.d.), Reimert et al. (2011), and Semelsberger (2009). On the other hand, in a stoichiometric mixture, a substance can (theoretically) be fully oxidized since the ratio of air and fuel allows for a perfect, or complete, combustion (Albrecht, 2004; Schmidt et al., 1994; Bahrami, 2015; Mines Paris – PSL, n.d.). A common example is the formation of mainly carbon monoxide in oxidation of a sub-stoichiometric fuel-air mixture, instead of mainly carbon dioxide in oxidation of a stoichiometric fuel-air mixture (Schmidt et al., 1994; Makaryan et al., 2023; Semelsberger, 2009; European Commission, 2019; Albrecht, 2004).

Other than carbon monoxide, partial oxidation of hydrocarbons also leads to production of hydrogen (as indicated above) (Reimert et al., 2011; Speight, 2020) or, in some cases, water (Osborn, 2014; Speight, 2020; Hiller et al., 2011). Adding steam to the partial oxidation reaction of a hydrocarbon fuel leads to the production of additional hydrogen (Reimert et al., 2011). Partial oxidation is only one part of the gasification process (Hiller et al., 2011; Speight, 2020).

### 2.1.2. Gasification

Gasification is a process in which solid, liquid or gaseous hydrocarbons, or biomass, are converted into syngas without combustion by using high temperatures (at least over 700°C) and a sub-stoichiometric amount of oxygen in the fuel-air mixture (Speight, 2020; Hiller et al., 2011; Speight, 2011; Dieringer et al., 2020). The resulting syngas consists of mainly carbon monoxide and hydrogen, although carbon dioxide, methane, sulphur dioxide, and other compounds can also be present (Speight, 2020; Hiller et al., 2011). Sometimes, steam is used instead of, or in addition to, oxygen (Speight, 2020; Speight, 2011; Hiller et al., 2011). Even carbon dioxide can be used instead of oxygen (dry reforming), depending on the application (Speight, 2020; Reimert et al., 2011). It is possible to use pressures higher than atmospheric in the gasification process, although the requirement depends on the specific application (Speight, 2011; Speight, 2020). There are many different types of the gasification process, owing to many applications of gasification (Speight, 2020). There are also many chemical reactions involved in gasification in addition to partial oxidation, such as dehydration, devolatilization, pyrolysis, etc. (Speight, 2020; National Energy Technology Laboratory [NETL], n.d.-a), which are beyond the scope of this thesis. The carbon monoxide from the resulting syngas is usually transformed into hydrogen and carbon dioxide, for which the water-gas shift reaction is used. If it is required to produce methane from carbon monoxide, or from carbon dioxide, methanation through hydrogenation can be used (Speight, 2020; Hiller et al., 2011; Mok et al., 2013).

### 2.1.3. Steam methane reforming

Steam methane reforming (SMR) is a process of producing syngas (hydrogen and carbon monoxide) through a reaction of methane with water (steam). The carbon monoxide from the resulting syngas can be transformed into additional hydrogen with the water-gas shift reaction, where carbon monoxide reacts with water (steam) once again. Carbon dioxide is also a main product of the water-gas shift reaction (Speight, 2020; Jansen et al., 2015;



Reimert et al., 2011). Steam methane reforming is currently responsible for most of the hydrogen production in the world (Makaryan et al., 2023; Franchi et al., 2020).

Since it is likely not economically, or technically, feasible to retrofit the pre-combustion CO<sub>2</sub> capture method at the Croatian LNG terminal, it is not going to be considered for the carbon capture project at the LNG terminal.

## **2.2. Post-combustion capture**

Post-combustion capture is a method of carbon dioxide capture applied after a fuel has been combusted. In particular, this is capture of CO<sub>2</sub> contained in the flue gases emitted by a process.

The method can generally be divided into absorption and adsorption technologies. Absorption is a process in which a substance (the absorbate) enters into, and is retained in, another material (the absorbent), such as a liquid or a solid (Encyclopaedia Britannica, 2024; Simon, 2020b; Tehnički leksikon, 2007). Absorption can be divided into chemical absorption and physical absorption (Simon, 2020b; Peu et al., 2023; Songolzadeh et al., 2014). In contrast, adsorption is a process in which a substance (the adsorbate) is adhered to, and retained on, the surface of a solid or a liquid material (the adsorbent) (Encyclopaedia Britannica, 2024; Simon, 2020b). Adsorption can also be divided into chemical adsorption and physical adsorption (Songolzadeh et al., 2014; Encyclopaedia Britannica, 2024; Simon, 2020b; Yu et al., 2012).

Chemical absorption is the most commonly used carbon capture technology (Chai et al., 2022; Khan et al., 2023). Chemical absorption means that a chemical substance (the absorbent) is used to cause a chemical reaction with a desired substance (the absorbate) from the feed stream in order to capture the absorbate (i.e. a chemical change occurs) (Simon, 2020b; Khan et al., 2023). In carbon capture, chemical absorption often employs a class of chemical compounds called alkanolamines, commonly referred to as amines, in order to

'capture' the CO<sub>2</sub> from the flue gas stream (Songolzadeh et al., 2014; Chai et al., 2022; Simon, 2020b; Faisal Elmobarak et al., 2023). Amines are commonly used for absorption of acid gases (e.g. H<sub>2</sub>S and CO<sub>2</sub>) at natural gas production facilities ("natural gas sweetening") or for CO<sub>2</sub> capture from flue gases at power plants, cement plants, steel mills, etc. (Parekh, 2020; Simon, 2020a; Yamada, 2020; Pashaei and Ghaemi, 2022). There are other kinds of absorbents used in carbon dioxide capture (and in carbon dioxide separation) as well, but these are not discussed in this thesis. The post-combustion process is the most attractive carbon capture process to retrofit onto existing plants (Bandilla, 2020; Chai et al., 2022; Franki et al., 2019) and the amine chemical absorption process is the most used post-combustion CO<sub>2</sub> capture technology (Chai et al., 2022; Faisal Elmobarak et al., 2023). Therefore, the amine chemical absorption process is going to be used for the feasibility study, as well as for simulation, and modelling, conducted in this thesis. Specifically, MEA is going to be used, as it is the most commonly used amine for carbon capture (Chai et al., 2022; Huang et al., 2019).

Physical absorption means that a physical property (or properties) of an absorbent, and of a certain desired substance, is used to attract the absorbate towards the absorbent and capture it from the feed stream (Simon, 2020b). Physical absorption usually requires a high pressure (i.e. a high partial pressure of CO<sub>2</sub>) and a low temperature in the carbon capture process and it is based on Henry's law (Peu et al., 2023; Simon, 2020b; Torralba-Calleja et al., 2013; Yu et al., 2012; M. Wang et al., 2011). Therefore, it is difficult to use physical absorption for post-combustion carbon capture, since pressures and the proportion of carbon dioxide in the composition of post-combustion flue gases are too low (Songolzadeh et al., 2014; M. Wang et al., 2011). Physical absorption is mainly used to remove acid gases, such as CO<sub>2</sub>, from gas streams which contain a high proportion of carbon dioxide, e.g. in facilities which process produced raw natural gas and in ammonia production plants (Simon, 2020a; Simon, 2020b; Kothandaraman, 2010; Šimunec, 2012). Some of the main physical solvents used for this purpose are Selexol, Purisol, Sulfinol, Rectisol, and fluorinated solvents (Songolzadeh et al., 2014; Simon, 2020b; Pashaei and Ghaemi, 2022; Šimunec, 2012). Sulfinol is a hybrid

solvent, meaning it is composed of both physical and chemical absorbents, so combinations of the two types of solvents are possible as well (Šimunec, 2012; Huang et al., 2019). Since the preparation processes for pre-combustion capture result in feed streams with a high CO<sub>2</sub> content, physical solvents can be used for pre-combustion carbon capture (Huang et al., 2019; Kothandaraman, 2010; Khan et al., 2023). A promising group of solvents for post-combustion physical absorption of carbon dioxide are ionic liquids (ILs), although much more research is needed before scaling up application of ILs into industry (Peu et al., 2023; Faisal Elmobarak et al., 2023; Torralba-Calleja et al., 2013; Chai et al., 2022; de Riva et al., 2017; Yu et al., 2012).

Chemical adsorption involves adhering, and retaining, a desired substance (the adsorbate) to the surface of the adsorbent material by a chemical change (e.g. a chemical reaction between the adsorbate and the adsorbent) (Simon, 2020b). Adsorbents can be regenerated and used again in the adsorption process. Adsorbents in carbon capture can be zinc oxide (ZnO), calcium oxide (CaO), magnesium oxide (MgO), (Li<sub>2</sub>ZrO<sub>3</sub>), (Li<sub>4</sub>SiO<sub>4</sub>), etc. (Songolzadeh et al., 2014; Simon, 2020b)

Physical adsorption involves adhering, and retaining, a desired substance (the adsorbate) to the surface of the adsorbent material because of a physical property (or properties) of the adsorbate and the adsorbent (Simon, 2020b). Adsorbents can be regenerated and used again in the adsorption process. Physical adsorbents used in carbon capture are usually molecular sieves (e.g. zeolites) (Songolzadeh et al., 2014), activated carbons (Songolzadeh et al., 2014; Lai et al., 2021), metal-organic frameworks (MOFs) (Lai et al., 2021; Songolzadeh et al., 2014), and certain other materials (Songolzadeh et al., 2014; Simon, 2020b; Lai et al., 2021).

It is also possible to modify adsorbents by combining multiple adsorbents, resulting in composite adsorbents. Even some absorbents, like MEA, can be impregnated into an adsorbent to improve the adsorbent's CO<sub>2</sub> adsorption capacity (Lai et al., 2021; Songolzadeh et al., 2014).

Since amine chemical absorption is going to be used for the techno-economic analysis conducted in this thesis, the amine carbon capture process is going to be described in more detail below.

### 2.2.1. Chemical reactions in the absorption of carbon dioxide with MEA

A literature review of the chemical reactions between CO<sub>2</sub> and the aqueous solution of MEA in the chemical absorption process reveals that there is still no final consensus on the exact reaction mechanism between carbon dioxide and MEA. There are several theories as to the exact reaction mechanism, of which the most significant are the zwitterion theory and the termolecular theory.

#### 2.2.1.1. *The zwitterion theory*

The zwitterion theory posits that carbon dioxide and MEA first react to form a zwitterion, which is then deprotonated to form a carbamate molecule, while the proton (the hydrogen atom) reacts with another MEA molecule (or another base) (Lv et al., 2015; Singh, 2009; Arachchige, 2019; Ma et al., 2023).

The first step is the formation of a zwitterion:

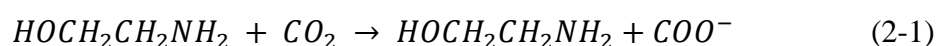

In this step, the amine group in the MEA molecule reacts with CO<sub>2</sub> to form a zwitterion. A zwitterion is a molecule that contains both positive and negative ions, but it has a neutral charge overall. Therefore, the MEA molecule gains a positive charge on the nitrogen atom (resulting in a protonated amine) and a negative charge on the oxygen atom (which is a part of the carboxylate anion, R-COO<sup>-</sup>). The structural formula of MEA is HOCH<sub>2</sub>CH<sub>2</sub>NH<sub>2</sub>. It is also possible to represent the functional group HOCH<sub>2</sub>CH<sub>2</sub> only with an R in shortened notation, resulting in R-NH<sub>2</sub> as a shorter form in reactions, which can also be observed in

literature. However, for the sake of clarity, the entire structural formula is going to be used to represent MEA and other molecules in reactions in this thesis. For a secondary amine, like DEA,  $R_1R_2NH$  or  $R_2NH$  can be used as a shortened structural formula in literature.

The next step is the deprotonation of the zwitterion to form a carbamate. Since MEA can also act as a base and accept a proton, another MEA molecule reacts with the zwitterion:

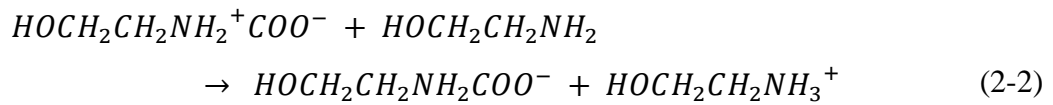

The zwitterion quickly deprotonates to form the carbamate ion ( $HOCH_2CH_2NH_2COO^-$ ). This step completes the capture of  $CO_2$  as a carbamate, which is now stabilized in the solution.

The reaction with the proton is also possible with a base other than the amine, like water or a hydroxyl ion ( $OH^-$ ) (Lv et al., 2015; Singh, 2009; Arachchige, 2019). In this general case, the reaction can be represented as:



Where B represents a base molecule.

The overall reaction of the zwitterion theory can then be summarised as:

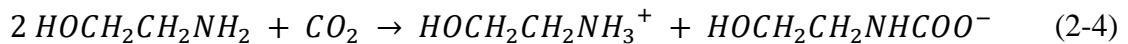

A study by Lv et al. (2015) showed that main reactions in the solution differ under low and high  $CO_2$  loading (a process parameter explained in chapter 2.2.3. Process parameters).

At high CO<sub>2</sub> loading, the carbamate is unstable and decomposes easily and CO<sub>2</sub> hydration is the main reaction. Therefore, a single reaction mechanism is not enough to represent all the possible reactions occurring during the absorption process.

#### 2.2.1.2. *The termolecular theory*

The termolecular theory posits, essentially, that three molecules are involved in the rate-determining step of the reaction. Sometimes, the termolecular theory is referred to as the “single-step” theory. Unlike in the previous theory, the first step is the formation of a loosely bound encounter complex instead of the zwitterion (Singh, 2009; Siemieniec et al., 2012; Lv et al., 2015; Ramachandran et al., 2006; B. Liu et al., 2017). The complex can be between a molecule of MEA and water or between two MEA molecules (Arachchige, 2019):

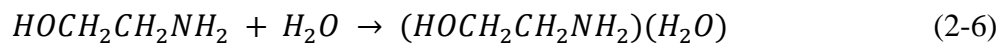
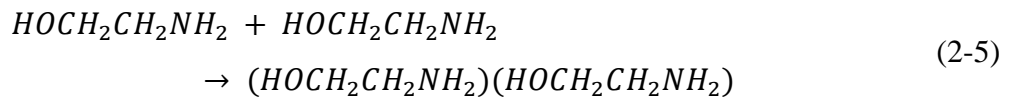

In this theory, the formation of the bond and proton transfer occur simultaneously and the overall reaction in both cases can be represented as:



Or:

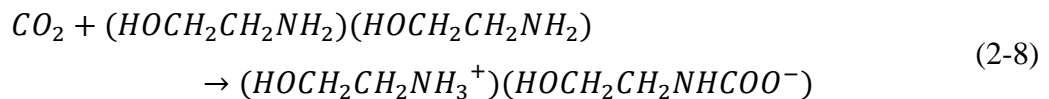

Or (Siemieniec et al., 2012):

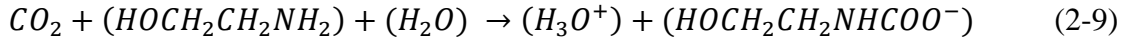

Or (Siemieniec et al., 2012):

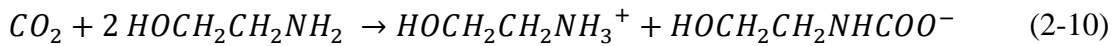

Since any base can form the loosely bound encounter complex with MEA, the following notation is also observed in literature (Lv et al., 2015):

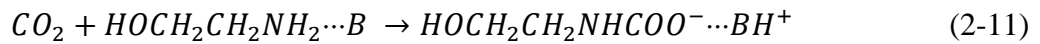

Or (Singh, 2009; Bhattacharya, 2021):

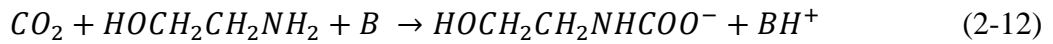

In some literature, authors also posit the formation of a loose bond between the CO<sub>2</sub> and MEA, although not in the form of a zwitterion, prior to the single step reaction in the termolecular theory (Fraij, 2023; Bhattacharya, 2021). Some have suggested that it is not impossible that a zwitterion can exist in the solution even if the termolecular theory is correct (Makul, 2021; Sumon et al., 2015). Some authors have criticised the termolecular theory as impossible, since it requires almost impossible continuous simultaneous collisions and reactions of three molecules, although other authors have disagreed with this criticism and offered possible explanations (Sumon et al., 2015; Siemieniec et al., 2012).

### 2.2.1.3. Carbamic acid theory

The carbamic acid theory is another theory regarding the reaction mechanism between CO<sub>2</sub> and MEA. In this theory, CO<sub>2</sub> reacts with MEA to form carbamic acid (R-NHCOOH), which is then deprotonated by another MEA molecule (or another base) to form a carbamate (Lv et al., 2015; Fraij, 2023; Sumon et al., 2015; Ma et al., 2023; Makul, 2021). Some authors suggest that the initial formation of the carbamic acid is due to the formation of a zwitterion, which protonates its carboxylate anion (R-COO<sup>-</sup>) via a proton relay or a proton wire (Sumon et al., 2015; Ma et al., 2023).

The formation of the zwitterion can be represented in the same way as in the zwitterion theory (equation (2-1)). The formation of carbamic acid from the zwitterion can then be represented as:

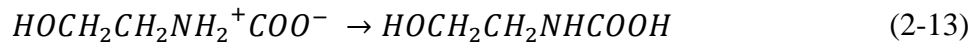

The formation of carbamic acid can also be, more generally, represented as (Lv et al., 2015; Sumon et al., 2015; Fraij, 2023):



Carbamic acid is a neutral species, but relatively unstable (Ouellette and Rawn, 2015; Altun et al., 2019) and quickly undergoes further reactions. Carbamic acid reacts with another molecule of MEA to form the carbamate ion and protonated MEA (Lv et al., 2015; Ma et al., 2023):

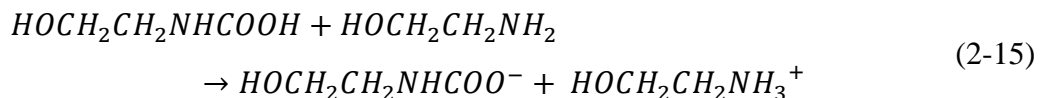



Actually, carbamic acid can react with any base, such as water, a hydroxyl ion (OH<sup>-</sup>), or an amine, so the formation of the carbamate ion can be represented more generally as (Sumon et al., 2015; Fraij, 2023):

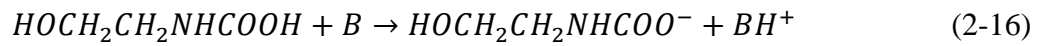

The overall reaction, in the carbamic acid pathway, can then be represented in the same way as in the zwitterion theory (in case the base molecule in the second step is another MEA molecule):

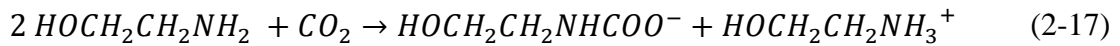

In any of the presented cases, once the carbon dioxide is trapped in the form of a carbamate molecule, it can be released with the help of heat in the desorber (stripper), when MEA is also regenerated. The predominant theory of the reaction mechanism between carbon dioxide and MEA is the zwitterion theory (Lv et al., 2015). There is a set of chemical reactions for the regeneration process as well (Gao et al., 2020), although these are not presented in this thesis.

### 2.2.2. Process equipment

The most commonly used equipment in the amine chemical absorption process are absorbers (also known as contactors or scrubbers) and desorbers (also known as strippers or regenerators), as well as heat exchangers, pumps, fans, compressors, separators, tanks, and mixers.

### 2.2.2.1. General process diagram

A general diagram of the amine carbon capture process is shown in Figure 2-1 below.

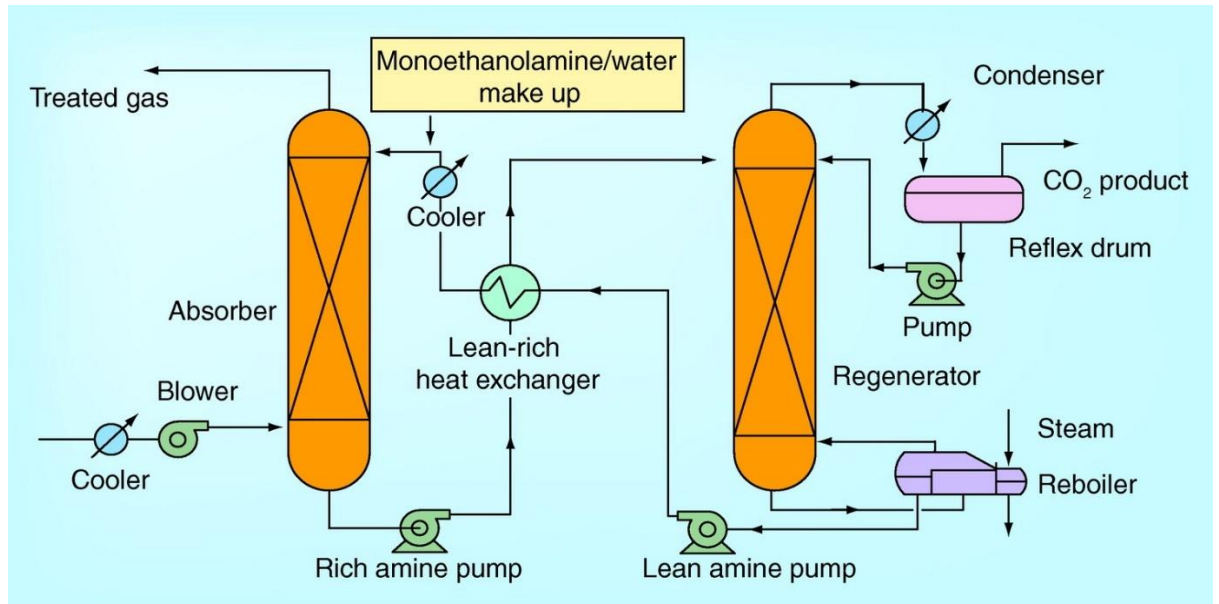

**Figure 2-1** General diagram of the amine carbon capture process (Liang, 2014)

The stream of flue gas first undergoes pre-treatment, usually in terms of SO<sub>x</sub> removal, NO<sub>x</sub> removal, PM (particulate matter) removal, and cooling. Then, the pre-treated flue gas enters the absorber at the bottom and moves upwards in the absorber. The stream of lean amine aqueous solution enters the absorber at the top and moves downwards in the absorber. In the absorber, a certain CO<sub>2</sub> removal efficiency is achieved through a chemical reaction of an amine and of CO<sub>2</sub>, both of which flow countercurrently to each other. The stream of cleaned flue gas (i.e. without a certain part of CO<sub>2</sub>) flows out from the top of the absorber.

The stream of rich amine (i.e. lean amine which has taken in CO<sub>2</sub> from the flue gas) exits the absorber at the bottom and passes through a pump, which raises rich amine's pressure prior to its passage through the rich/lean amine heat exchanger. In the heat exchanger, the rich amine attains a higher temperature, which lowers the amount of heat necessary for heat

transfer in the desorber, thereby reducing the reboiler energy required for amine regeneration.

After rich amine passes through the heat exchanger, rich amine enters into the stripper column (the desorber) at one of the top stages and flows downwards in the desorber. A stream of hot steam (at the regeneration temperature of the amine) enters the stripper at the bottom and flows upwards in the stripper, countercurrently to the rich amine. The steam comes from the reboiler and the process is explained in more detail below. In the desorber, a certain CO<sub>2</sub> removal efficiency (removal from the rich amine) is achieved through breaking of the chemical bonds between amine and CO<sub>2</sub> (most probably a carbamate molecule, as discussed above in chapter “2.2.1. Chemical reactions in the absorption of carbon dioxide with MEA”), which is enabled by the transfer of heat from hot steam onto the rich amine solution.

A stream predominantly composed of water and CO<sub>2</sub> (with possibly only a small fraction of O<sub>2</sub>, N<sub>2</sub>, MEA, etc.) flows out from the top of the stripper into the condenser. Water (or another medium) can cool the condenser in order to condense the water from the stream. From the condenser, a condensed water mixture flows back into the stripper (this is the desorber reflux stream), while a vapour mixture with CO<sub>2</sub> and remaining water flows out from the top of the condenser. After leaving the condenser, the CO<sub>2</sub> mixture can be processed further in order to achieve a required purity or it can be transported to another site for processing. Further processing can include separators (e.g. with cooling to ensure greater removal of water), dehydration, liquefaction, etc. The stream of water flowing out of the separator could be reused for make-up water (explained below), for a potential “water wash” in the absorber to reduce amine loss, or be processed and disposed of in accordance with environmental regulations.

The amine solution (from the stripper) flows out from the bottom of the stripper into the reboiler, where it is further heated. It is the heating of the solution that usually makes up the

largest share of the cost of an amine carbon capture project. In the reboiler, much of the water from the solution boils up to form steam, which flows into the stripper at the stripper's bottom and moves upwards, countercurrently to the rich amine flow. The amine does not largely boil up into steam because of the boiling point of the amine. For example, the boiling point of MEA is at around 170°C at 101,325 Pa (National Oceanic and Atmospheric Administration [NOAA], 2024; National Center for Biotechnology Information [NCBI], 2024; National Institute of Standards and Technology [NIST], 2023).

The remaining amine solution, containing predominantly the amine (e.g. MEA), and the remaining CO<sub>2</sub> and water, flows out from the reboiler. This stream is usually called the "bottoms product". The bottoms stream flows into the rich/lean amine heat exchanger to provide heat to the lean amine flowing into the stripper. Once the bottoms product stream flows out of the heat exchanger, it heads towards the mixer in order to regenerate the original amine solution (e.g. a 30% MEA solution). Proper amounts of water and/or MEA are usually added into the solution, which is now the original lean amine solution. In practice, the lean and rich amine solutions always contain certain amounts of CO<sub>2</sub> ("CO<sub>2</sub> loading"), a situation which is further explained below.

The regenerated amine solution then passes through a cooler (usually a heat exchanger), where the original solution temperature of the lean amine is achieved. There could also be a pressure drop in the cooler, bringing the solution pressure down to the original solution pressure of the lean amine, or there could be an additional pump in order to raise the pressure of the solution. From this point, the process with (the regenerated) lean amine continues as from the beginning.

#### 2.2.2.2. *Equipment*

An absorption column or tower (also known as an absorber or a contactor or a scrubber) is a process vessel in chemical engineering in which a unit operation of chemical absorption occurs in an overall chemical process, e.g. the amine gas treating process, including carbon capture from flue gases (Simon, 2020b). As described above, flue gas enters the absorber at the bottom, while the amine solution enters at the top of the absorber. The gas and the liquid make contact while in countercurrent flow in the absorber, which is when the desired chemical reaction (or reactions) occur. For some chemical processes, cocurrent flow in an absorber is desired instead (Schaschke, 2014). There are internal elements in the absorber, which are designed so that the contact area between the two phases in countercurrent flow is maximized in such a way that it enables the desired chemical reaction(s) to occur at the desired rate and yield. These internal elements are either trays (also known as plates) or packing. For some chemical processes, empty absorbers, without internal elements, are desired instead (Schaschke, 2014). There are many different kinds of trays, as shown in figures below, e.g. sieve trays, bubble-cap plates, and valve trays (Theodore and Ricci, 2010). A whole tray absorption column can be seen in Figure 2-2. Figure 2-3 illustrates the contact of fluids on a bubble cap tray. Figure 2-4 also illustrates the contact of fluids on a bubble cap tray. Figure 2-5 shows the illustration of a bubble cap in HYSYS. Figure 2-6 shows an entire tray with bubble caps. Figure 2-7 shows a stack of sieve trays. Figure 2-8 illustrates operation of an absorption column with sieve trays.

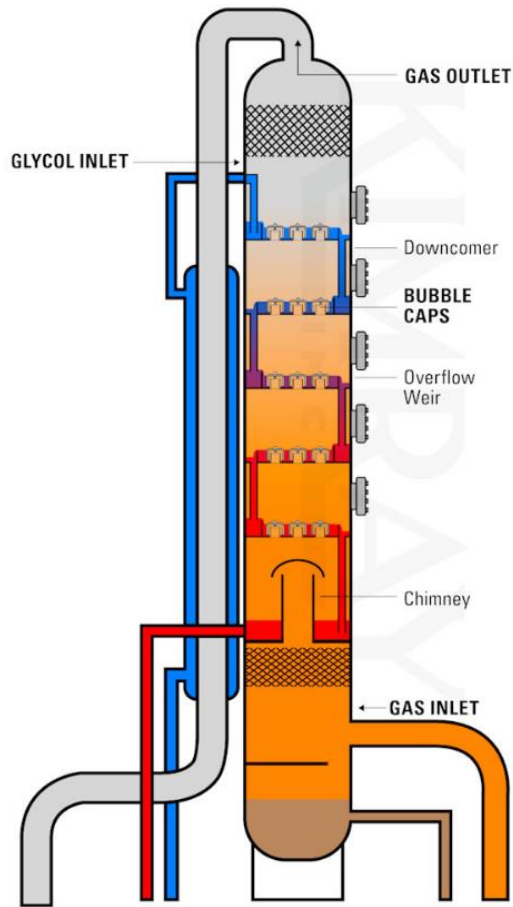

**Figure 2-2** Tray absorption column with bubble caps and triethylene glycol (TEG) as the absorbent for natural gas dehydration (Kimray.com, 2023)

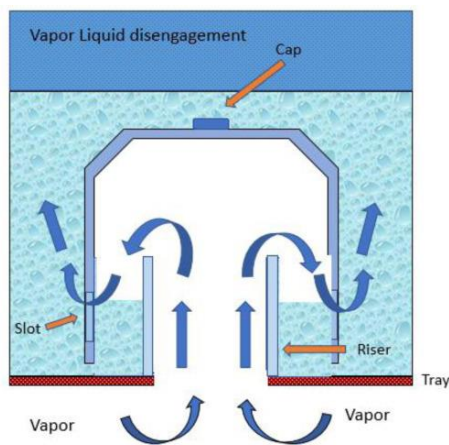

**Figure 2-3** Illustration of flows on a bubble cap tray (Hossain et al., 2023)

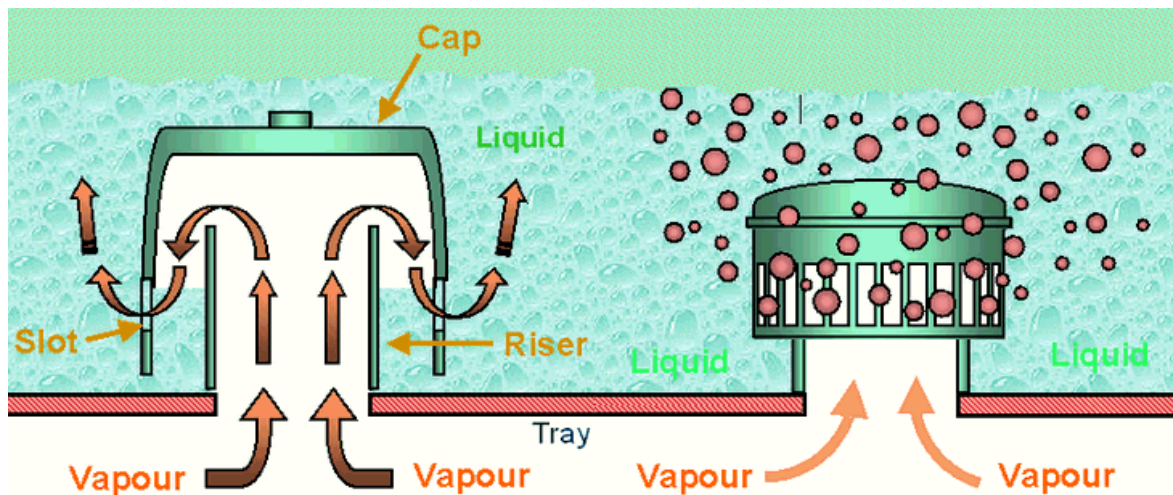

**Figure 2-4** Illustration of flows on a bubble cap tray with bubbles (Hossain et al., 2023)

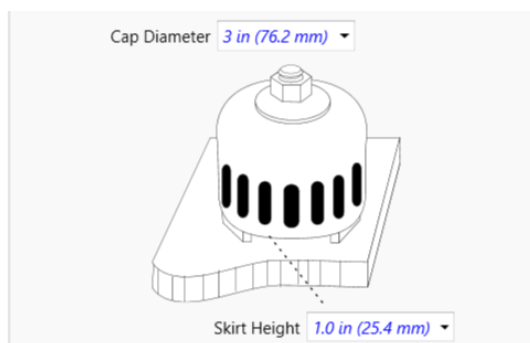

**Figure 2-5** Illustration of a bubble cap on a tray from the column internals menu in HYSYS

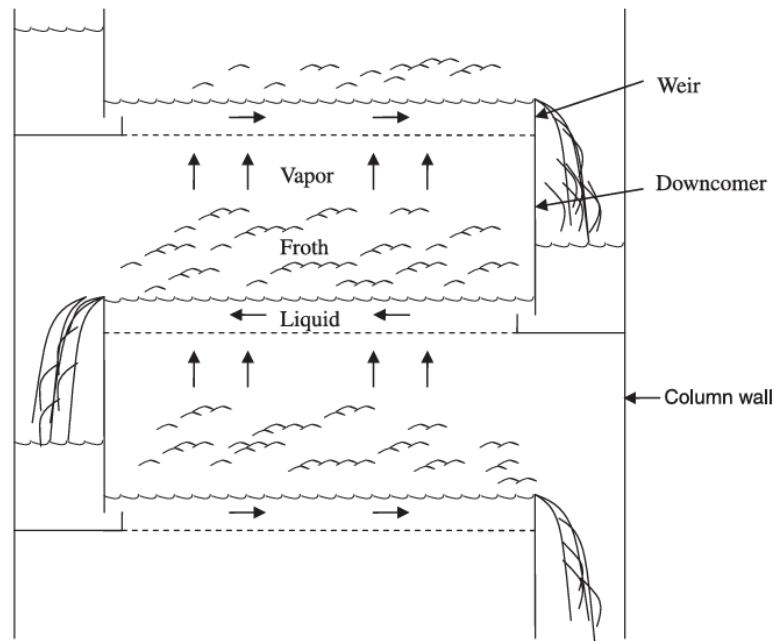

**Figure 2-6** A tray with bubble caps (Kimray.com, 2023)



**Figure 2-7** A stack of sieve trays of an absorption column (University of Michigan, 2024)





**Figure 2-8** Illustration of operation of a sieve tray absorption column (Theodore and Ricci, 2010)

The liquid flows across each tray on its way to the bottom. The gas moves upwards through openings in the trays, bubbles through the liquid, forming a froth, and passes to the next tray above. During the contact between the gas and the liquid, desired chemical reactions occur. Each column tray is a so-called (reaction) stage. The amount of required theoretical stages (also called ideal stages, theoretical trays or plates, and equilibrium stages) in tray absorption columns can be determined based on the graph of operating and equilibrium lines, although this well-known method is more appropriate for binary mixtures, while mixtures involved in applications in the industry often contain more than two components. There are analytical methods, as presented by Theodore and Ricci (2010), which can also be applied to multicomponent mixtures. However, in practice, since thermodynamics of multicomponent vapour-liquid equilibrium are very complex, column design calculations are often carried out on a stage-by-stage basis by computer programs. Such computer programs use the iterative method to arrive at an approximate solution, which

is exactly the nature of HYSYS. It is safe to say that the amount of required theoretical stages is going to depend on the operating conditions and the desired reaction rates and yields.

In practice, the actual number of stages is going to be higher than the number of required theoretical stages because of tray efficiencies (or inefficiencies) in chemical reactions (it is not practical to allow mixtures to spend enough time at each tray to reach equilibrium). There are several types of tray efficiencies, for example the Murphree efficiency (individual tray efficiency) (Theodore and Ricci, 2010). Murphree efficiency can be specified in the Efficiency calculation mode in HYSYS.

Most of the overall column height is determined by two factors: the actual number of trays and the distances between trays (tray spacing). Tray spacing depends on the nature and operating conditions of the process, as well as the column diameter. Standard tray spacings are 16, 24, and 36 inches (roughly 400 mm, 600 mm, and 900 mm), although larger and smaller spacings are possible (Theodore and Ricci, 2010). Larger spacing is useful in case the reaction components tend to foam and in the need for easier maintenance access. Smaller spacings are common in, for example, columns which separate air components at cryogenic temperatures. Other process considerations are also employed to determine the final height of the column, such as leaving additional space at the bottom for liquid collection in case a pump malfunctions. It is not unusual to provide additional space in advance in case more trays need to be added in the future. Theodore and Ricci (2010) provide an extensive coverage of many aspects of the design of trayed columns.

Packing are objects that are used in packed columns to provide a large contact surface area (per unit volume) between the reactants (Schaschke, 2014). There are many types of packing objects made of many types of packing materials. There exists structured and unstructured packing. Structured packing can consist of many arranged sheets of corrugated metal (Schaschke, 2014), as shown in Figure 2-9. Figure 2-10 shows a packed column with additional images of its internal elements. Unstructured packing consists of small objects which are randomly arranged, such as saddles and rings (Schaschke, 2014). Structured

packing provides a higher contact area between phases than unstructured packing (Orangi, 2021). Packing can be made of materials such as metal, ceramic, plastic, glass, etc. (Schaschke, 2014). Packed columns are most often used in absorption processes (Theodore and Ricci, 2010). Structured packing is going to be used for the modelling of absorbers in this thesis.



Gauze



Sheet Metal

**Figure 2-9** Gauze structured packing and sheet metal structured packing (Kimray.com, 2023)

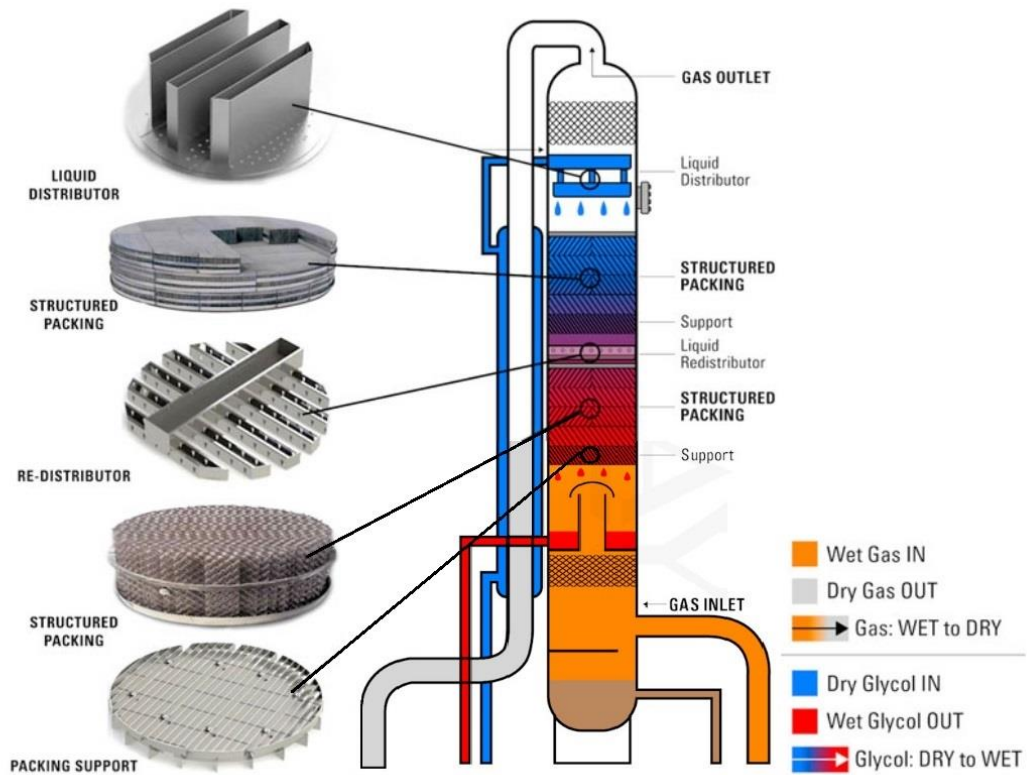

**Figure 2-10** Absorption tower with structured packing and triethylene glycol (TEG) as the absorbent for natural gas dehydration (adapted from Kimray.com, 2023)

The concept of equilibrium stages is also applied in designing of packed absorber columns. The height of the packing section of a column can be estimated by the equation:

$$Z = N_{OG} \times H_{OG} \quad (2-18)$$

where  $N_{OG}$  represents the number of overall transfer units,  $H_{OG}$  represents the height of a single transfer unit, and  $Z$  is the height of the column packing (Theodore and Ricci, 2010).  $N_{OG}$  is sometimes referred to as the number of transfer units (NTU) and  $H_{OG}$  is sometimes referred to as the height of a transfer unit (HTU) (Michaels, 2024; Theodore and Ricci, 2010; Graf, 2011). The concept of  $N_{OG}$  in packed columns is analogue to the concept of stages in trayed columns.  $N_{OG}$  is a dimensionless number (Graf, 2011; Michaels, 2024). Theodore and

Ricci (2010), indicate that  $N_{OG}$  can be determined experimentally or analytically through several methods they outline.  $H_{OG}$  represents the height required for a change in composition as in a single transfer unit (Schaschke, 2014).  $H_{OG}$  can also be obtained experimentally and from literature, although it is usually obtained from the manufacturer (Theodore and Ricci, 2010).  $H_{OG}$  only has the dimension of length (height).

Height equivalent to a theoretical plate (HETP) is a related concept, which indicates the required height of packing for the same change in composition as in one theoretical plate (Schaschke, 2014; Theodore and Ricci, 2010). The concept of HETP is different from  $H_{OG}$  because HETP relates the packing height to the number of theoretical stages, as if the process were conducted on trays, while  $H_{OG}$  relates the packing height to the number of transfer units, a measure which is specific to packed columns. HETP also has the dimension of length (height). The height of packing can also be determined from HETP by multiplying the obtained number of required theoretical stages with HETP (Schaschke, 2014), although Graf (2011) claims that this requires a certain correction.

There are numerous procedures for determining the height of a packed column, but the  $N_{OG} - H_{OG}$  procedure is the most simple and, currently, the most used one (Theodore and Ricci, 2010). Liang et al. (2014) provide an extensive description of several methods for designing an absorber column specifically for the case of post-combustion carbon capture using chemical absorption. Graf (2011) extensively covers the concepts of NTU, HTU, HETP, their calculation, and their relationships. In Advanced Calculation mode of HYSYS, “stage packing height” can be set as a similar parameter. Theodore and Ricci (2010) provide an extensive coverage of many aspects of the design of packed columns.

A rich/lean heat exchanger is a heat exchanger in the absorption process tasked with heating the rich amine solution coming from the absorber and cooling the lean amine solution (before makeup) coming from the stripper (or, more precisely, from the reboiler). The purpose of heating the rich amine solution is to reduce the reboiler duty of the desorption

column. The purpose of cooling the lean amine is to reduce the required duty for the heat exchanger tasked with cooling the lean amine before entry into the absorber (Orangi, 2021).

After passing through the rich/lean heat exchanger, the rich amine enters into the stripper, while the lean amine solution can go to makeup and further temperature modification before returning into the absorber. In simulations and modelling for this thesis, the rich/lean heat exchanger is a “shell & tube” heat exchanger of TEMA (Tubular Exchanger Manufacturers Association) Type AFL. Letters A and L designate the type of the front header and the rear header, respectively, while the letter F designates the type of the exchanger’s shell (Brogan, 2011; Enerquip, 2018). The F shell type enables pure countercurrent flow. Countercurrent flow can provide the greatest temperature exchange between the fluids in comparison with other flow types (Enerquip, 2024; Patel, 2023). Therefore, an exchanger with countercurrent flow is used for simulations and modelling in this thesis. An illustration of the F shell type can be seen in Figure 2-11. Sometimes, a crossflow heat exchanger is used (Orangi, 2021; Kothandaraman, 2010).

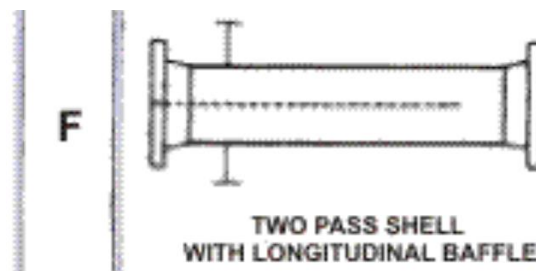

**Figure 2-11** TEMA's official illustration of the F shell type of heat exchangers (Brogan, 2011)

A desorption column or tower (also known as a desorber or a stripper or a regenerator) is a process vessel in chemical engineering in which a unit operation of chemical desorption, or stripping, occurs in an overall chemical process, e.g. the amine gas treating process, including carbon capture from flue gases (Simon, 2020b). As described above, the rich amine solution enters the desorber near the top, while the hot steam enters near the bottom of the desorber. The steam and the rich amine solution make contact while in countercurrent

flow in the desorber, which is when the reversal of a chemical reaction (or reactions), in relation to absorption, occur. There are internal elements in the desorber, just like in the absorber, which are designed so that the contact area between the two phases in countercurrent flow is maximized in such a way that it enables the desired chemical reaction(s) to occur at the desired rate and yield. These internal elements are also trays or packing.

The separated carbon dioxide exits the desorber at the top along with steam and perhaps other impurities, while the stripped solvent exits the desorber at the bottom. The vapour stream (the stream of separated carbon dioxide and steam) enters into the condenser, while the liquid stream (the stream of stripped solvent) enters into the reboiler.

A condenser is, essentially, a heat exchanger in which the vapour stream is separated into a liquid phase and a gaseous phase through cooling with an appropriate medium (Orangi, 2021). As evidenced in the stripper configuration options in HYSYS, the condenser can be a total, a partial, or a full reflux condenser. In a total condenser, the vapour stream is completely liquefied (condensed) and a part of the condensate enters back into the stripper near the top as the reflux, while the other part of the condensate is sent to further processing. In a partial condenser, the vapour stream is partially condensed and the remaining gaseous phase is sent to further processing. One part of the condensate enters the stripper near the top as reflux, while the other part of the condensate is sent to further processing. In a full reflux condenser, the vapour stream is partially condensed and the remaining gaseous phase is sent to further processing. However, the entire condensate enters the stripper near the top as reflux.

The purpose of reflux in stripper columns is to serve as a water wash stream for the column, which can reduce amine losses through the rising vapour stream (Kothandaraman, 2010). There are certain other purposes of reflux in distillation columns, such as to cool and, thereby, condense heavier components in the rising vapor stream, preventing them from entering the condenser and returning them to the column's bottom, which improves the stripping efficiency and reduces the condenser's energy requirements for cooling

(Emerson.com, 2024; chemeurope.com, 2024; Green and Southard, 2019). Furthermore, as the down-flowing liquid reflux interacts with the rising vapor, heat and mass transfer effects cause the vapour stream to revapourize the lighter (lower boiling temperature) components of the reflux, while heavier (higher boiling temperature) components of the reflux condense the heavier components of the vapor stream (Theodore and Ricci, 2010). Additionally, the number of required trays decreases as more reflux is used. Likewise, the number of required trays increases as less reflux is used (Schaschke, 2014). Although a stripper is essentially a carbon dioxide removal distillation column (Shi, 2014), its operation is somewhat different from conventional distillation columns, so the benefit of these other indicated purposes from literature is unclear for amine carbon capture processes.

The vapour stream exiting the condenser is the stream which contains the entire CO<sub>2</sub> product from the absorption process. The rest of the carbon dioxide is either cycled or not captured. The vapour stream is usually sent to further processing and purification of the desired product.

A reboiler is essentially a heat exchanger, which is used to heat, and boil, the stripped amine aqueous solution coming out at the bottom of the stripper (Simon, 2020b; Fisher et al., 2005). It is usually a kettle type reboiler (Simon, 2020b), which falls under the shell and tube heat exchanger classification and corresponds to the TEMA shell type K (Enerquip, 2018; Patel, 2023; Brogan, 2011). A heating medium passes through the tubes and passes the heat onto the mixture in the shell of the heat exchanger. The heating medium in an amine carbon capture operation (and in amine gas sweetening operations) is usually hot water steam (Fisher et al., 2007; Duval, 2023; Simon, 2020b). Therefore, a certain amount of water from the solution boils up to form steam, which flows into the stripper at the stripper's bottom and moves upwards, countercurrently to the rich amine flow to provide the heat needed to strip the amine solution of its CO<sub>2</sub> content (i.e. to provide the heat needed to reverse the chemical reaction which occurred between the amine and CO<sub>2</sub> in the absorber). Most of the CO<sub>2</sub> then flows upwards with the steam towards the condenser, while most of the amine then flows downwards towards the reboiler (Simon, 2020b). The vapour stream coming out of the



reboiler is referred to as the boil-up. The liquid amine solution coming out from the reboiler is referred to as the bottoms product (Theodore and Ricci, 2010; Green and Southard, 2019). The amine does not largely boil up into steam because of the boiling point of the amine. For example, the boiling point of MEA is at around 170°C at 101,325 Pa (NOAA, 2024; NCBI, 2024; NIST, 2023).

It is the heating of the solution that usually makes up the largest share of the cost of an amine carbon capture project (Nyssen, 2022; Simon, 2020b; Orangi, 2021), since a fossil fuel, like natural gas, is usually purchased to provide energy for steam generation through combustion of the fuel. Additionally, CO<sub>2</sub> emission allowances should be bought in the EU ETS if the rated thermal input of the combustion unit is above 3 MW and the sum of all rated thermal inputs of the installation is above 20 MW, per criteria from Annex I of the Directive 2003/87/EC of the European Parliament and of the Council (OJ, Series L 275, 25.10.2003). If the rated thermal input of the combustion unit is not above 3 MW, the combustion unit is not counted towards the sum of all rated thermal inputs of the installation for the purpose of (possible) participation in the EU ETS.

In conventional thermal power plants with post-combustion carbon capture, a part of the steam generated for the turbine can be used for the reboiler. This lowers the efficiency of power generation of the power plant and raises the cost of power production per unit of electrical energy (e.g. USD/MWh or EUR/MWh). Figure 2-12 and Figure 2-13 illustrate a kettle type reboiler.

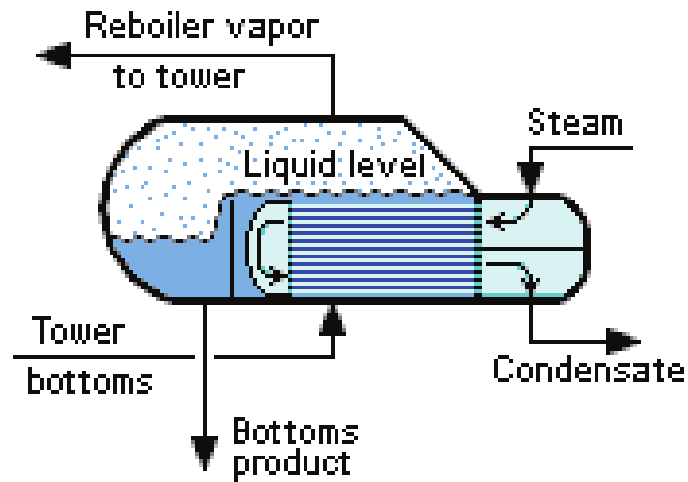

**Figure 2-12** Kettle type reboiler (Parmar and Shah, 2017)

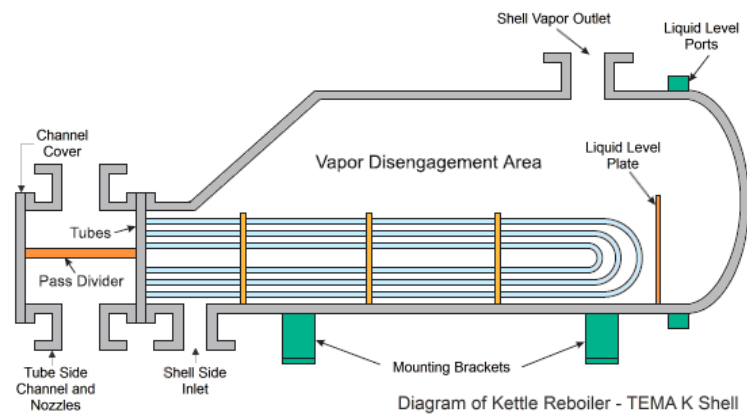

**Figure 2-13** Kettle type reboiler (enggyclopedia.com, 2023)

Other equipment is also used in the process, such as pumps, coolers, compressors, fans, and mixers. Coolers are heat exchangers and these are used in pre-treatment and, for example, to adapt the temperature of the lean amine before amine enters the absorber. An example of a cooler in the pre-treatment of a flue gas is a direct contact cooler (DCC). A DCC cools down the flue gas before flue gas enters the absorber. The DCC does so through direct contact of the flue gas and a cooling medium (e.g. water), both of which flow countercurrently to each other in the vessel (Orangi, 2021). There is, also, other equipment

required for pre-treatment processing of the flue gases before their entry into the absorber. Other pre-treatment processes are usually SO<sub>x</sub> removal, NO<sub>x</sub> removal, and PM removal. More details on pre-treatment processes and equipment are in chapter 4.2. Modelling and Simulation. Pumps are used to provide pressure and velocity to liquids in the process, e.g. when the rich amine solution exits the absorption column. A mixer is used for the purpose of adding makeup water, or makeup amine, to a stream in order to completely regenerate the original amine aqueous solution before amine enters into the absorber. The type of mixer that could be used for this purpose is an inline or a static mixer. A fan is needed in order to provide pressure to the flue gas before entry into the absorber. A fan enables the flue gas to overcome the pressure drop in the absorber and flow through (Orangi, 2021). In some carbon capture processes, a compressor might be used for this purpose. In this thesis, it is presumed that two industrial high-temperature fans provide a two-stage compression of the flue gas flowing into the absorber.

There are many possible improvements of the process. For example, a water wash can be used to reduce amine losses in the process. More specifically, it is possible to insert a stream (or multiple streams) of water into a process vessel, like the absorber, which flows countercurrently to the cleaned flue gas and absorbs the amine flowing out with the cleaned flue gas, thereby reducing amine losses. Such a stream could be made up of reusable water from the carbon capture process itself. For example, a part of the condensate from the condenser of the stripper could be used for the water wash stream. If full reflux is not used, the part of the condensate unused for reflux would otherwise be wastewater sent for further treatment and disposal. Water from the purification process of produced carbon dioxide (e.g. the cooling separator modelled in this thesis after the condenser) could also be used for this purpose. Such water could also be used for the purpose of amine make-up, although such considerations are beyond the scope of this thesis. Further possible improvements are outlined in chapter “6. Further study considerations”.

### 2.2.3. Process parameters

There are several process parameters that are usually evaluated in order to better assess the designed carbon capture process, such as the loading capacity, absorption capacity, cyclic capacity, cyclic loading, and regeneration energy.

#### 2.2.3.1. Loading capacity

Loading capacity ( $\alpha$ ) is the ratio of the number of moles of CO<sub>2</sub> in the aqueous solution and the number of moles of amine in the aqueous solution. It has the unit of mol CO<sub>2</sub>/mol amine (Orangi, 2021; Singh, 2009; Kothandaraman, 2010; Soo et al., 2024). Since there is a rich, and a lean, amine stream in the process, there is also rich ( $\alpha_{rich}$ ), and lean ( $\alpha_{lean}$ ), loading capacity (Orangi, 2021). Sometimes, the used unit is mol CO<sub>2</sub>/kg amine (Singh, 2009; Soo et al., 2024). The parameter is referred to in various ways in literature, e.g. rich loading, lean loading, CO<sub>2</sub> loading, amine loading, rich amine loading, lean amine loading, rich CO<sub>2</sub> loading, lean CO<sub>2</sub> loading, CO<sub>2</sub> lean loading, loading capacity of CO<sub>2</sub>, etc. (Orangi 2021; Singh, 2009; Kothandaraman, 2010).

For MEA, the maximum CO<sub>2</sub> loading capacity is limited to 0.5 mol CO<sub>2</sub>/mol amine because of stoichiometry, when carbamate formation becomes the only reaction (Singh, 2009). However, at high partial pressures of CO<sub>2</sub>, carbamate can hydrolyse and produce additional amine molecules, which can react with more CO<sub>2</sub> molecules. In this case, the CO<sub>2</sub> loading capacity of MEA can be greater than 0.5 mol CO<sub>2</sub>/mol amine (Singh, 2009).

The formula for loading capacity is given as (Orangi, 2021):

$$\alpha = \frac{n_{CO_2}}{n_{amine}} \quad (2-19)$$

where  $n_{CO_2}$  is the number of moles of CO<sub>2</sub> in the aqueous solution and  $n_{amine}$  is the number of moles of amine in the aqueous solution.

Sing (2009) claims that another metric, the volumetric CO<sub>2</sub> capacity, expressed in mol CO<sub>2</sub>/litre of solution, is sometimes a more practical parameter than CO<sub>2</sub> loading in mol CO<sub>2</sub>/mol amine.

#### 2.2.3.2. *Absorption capacity*

Absorption capacity (AC) is defined as the number of moles of CO<sub>2</sub> absorbed in 1 litre of an aqueous amine solution at equilibrium (Orangi, 2021). Orangi (2021) indicates that this parameter signifies the potential carbon dioxide carrying capacity of the amine and provides the following formula for AC:

$$\text{Absorption Capacity (AC)} = \alpha_{rich} \times C \quad (2-20)$$

where  $\alpha_{rich}$  is the CO<sub>2</sub> loading of an amine solution at equilibrium, while C is the molar concentration of an amine solution in mol amine/litre. Therefore, the AC has the unit of mol CO<sub>2</sub> /litre. On the other hand, Singh (2009) also refers to (CO<sub>2</sub>) absorption capacity as rich loading and provides several other units, namely mole CO<sub>2</sub>/mole amine, mole CO<sub>2</sub>/kg amine, and kg CO<sub>2</sub>/mol amine. Singh (2009) also uses the term desorption capacity to refer to lean loading. Higher absorption capacity and lower desorption capacity of an amine are better for the process, as such capacities are going to decrease the solvent circulation rate (in kg/hr) and, therefore, the amount of used amine, which is economically beneficial to the design of the process (Singh, 2009).

#### 2.2.3.3. *Cyclic loading*

Cyclic loading is defined as the difference between rich and lean CO<sub>2</sub> loading (Orangi 2021; Singh, 2009; Nwaoha et al., 2016):

$$\text{Cyclic Loading} = (\alpha_{rich} - \alpha_{lean}) \quad (2-21)$$

Singh (2009) refers to this quantity as effective loading and cyclic CO<sub>2</sub> loading as well. The units used for cyclic loading are mol CO<sub>2</sub>/mol amine (Orangi, 2021; Singh, 2009; Nwaoha et al., 2016) and mol CO<sub>2</sub>/kg amine (Singh, 2009). Cyclic loading is a quantity of CO<sub>2</sub> that travels (or cycles) from the absorber unit to be taken out of the process in the stripper unit (i.e. the final product). A higher cyclic loading of an amine is going to decrease the solvent circulation flow rate (in kg/hr) and affect the dimensions of equipment, such as the heat exchanger, the reboiler, amine pumps, the absorber, and piping in general (Singh, 2009). It is also going to reduce the consumption of electricity of amine pumps and of energy for heating of the solvent (Singh, 2009). An absorber with smaller dimensions is going to require a flue gas blower (or a fan) with lower energy consumption and dimensions (Singh, 2009).

#### 2.2.3.4. *Cyclic capacity*

Cyclic capacity (CC) is defined as the amount of CO<sub>2</sub> desorbed from the process per volume of the amine solution (Orangi, 2021; Ma'mun, 2005):

$$\text{Cyclic Capacity} = (\alpha_{rich} \times \alpha_{lean}) \times C \quad (2-22)$$

where  $\alpha_{rich}$  is the CO<sub>2</sub> loading after exit from the absorber, while  $\alpha_{lean}$  is the CO<sub>2</sub> loading after regeneration of the amine solution, and C is the molar concentration of an amine solution in mol amine/litre (Orangi, 2021). It can be noted that CC is CL multiplied by the concentration of the amine solution (Nwaoha et al., 2016). Therefore, the unit used for CC is mol CO<sub>2</sub>/litre, which is confirmed by Apaiyakul et al. (2022a). However, Ma'mun (2005) and Soo et al. (2024) also provide mol CO<sub>2</sub>/mol amine as a unit for cyclic capacity, while Nwaoha et al. (2016) provide both kmol CO<sub>2</sub>/m<sup>3</sup> of solution and mol CO<sub>2</sub>/litre of solution as units for CC. Soo et al. (2024) also provides mol CO<sub>2</sub>/kg as a unit for cyclic capacity. Figure 2-14 illustrates the concept of cyclic capacity.

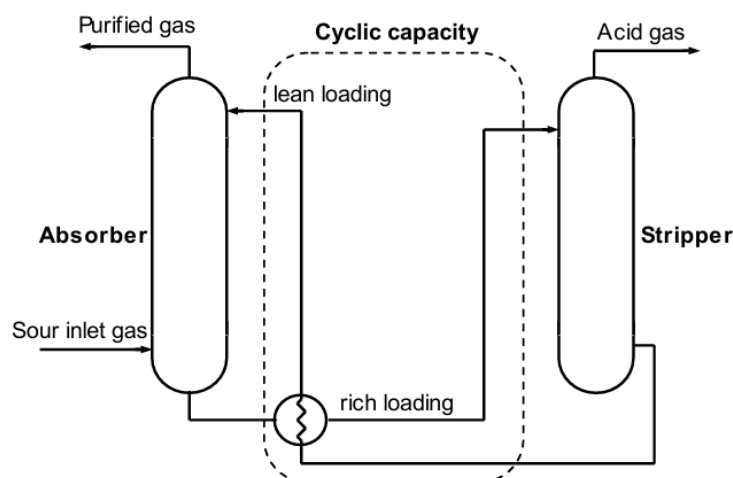

**Figure 2-14** Illustration of cyclic capacity (Ma'mun, 2005)

Both Orangi (2021) and Singh (2009) also refer to cyclic capacity as the difference of lean and rich CO<sub>2</sub> loadings. CC is important for evaluation of solvents. A higher CC is going to result a smaller solvent circulation rate, which is going to reduce the dimensions of the plant. The increase in CC is expected to reduce the capital costs, utility consumption and should result in lower cost of carbon capture. Higher CC could also result in decreasing the difference between absorption and regeneration temperatures, which would reduce the amount of energy required for heating and cooling of the solvent (Singh, 2009).

A standard of the International Organization for Standardization (ISO) outlining “*key performance parameters and characterization methods of absorption liquids for post-combustion CO<sub>2</sub> capture*” is currently in draft stage as ISO/DIS 27927. The upcoming standard is going to codify quantities discussed above and their units.

#### 2.2.3.5. Reboiler duty and regeneration energy

Reboiler duty (also called reboiler heat duty) is the (thermal) power required for operation of the reboiler, usually expressed in kW or MW. Regeneration energy is the amount of (reboiler’s) heat energy required in the process per mass quantity of CO<sub>2</sub> coming out of the

condenser of the stripper (i.e. the product), usually expressed in MJ/kgCO<sub>2</sub> or GJ/tCO<sub>2</sub> (Orangi, 2021; Topham et al., 2014; Agbonghae et al., 2014; Goto et al., 2011). Regeneration energy is also called the specific thermal energy requirement of regeneration (Topham et al., 2014). Therefore, the regeneration energy determines the reboiler duty.

Regeneration energy is different for every solvent and every process design. The required heat for regeneration energy (the total heat consumption) is made up of (Topham et al., 2014; Orangi, 2021; Oyenekan and Rochelle, 2007; Z. Li et al., 2015; Kothandaraman, 2010; S. Lu et al., 2023) the heat of reaction (also known as the heat of absorption or heat of desorption, etc.), the sensible heat, the stripping heat, and the heat needed for heating the condensate reflux. The heat of reaction is the heat released in the exothermic absorption reaction between CO<sub>2</sub> and the amine. This heat must be brought back to the solution in order to reverse the absorption process. However, the reversal does not begin to occur until the solution is at a required temperature, e.g. 120 - 130°C for some amines. Therefore, it is necessary to provide sensible heat, which is the heat required to bring the solution to the desorption temperature. The stripping heat is related to the heat necessary for vaporization of water (stripping steam generation). It is also necessary to heat the reflux coming from the condenser, as the reflux cools the solution while flowing downwards (Agbonghae et al., 2014).

In HYSYS, the regeneration heat, and the reboiler duty, are determined by manually selected process parameters for the stripper (such as reflux ratio and reboiler temperature), as outlined in chapter “4. Modeling post-combustion capture of CO<sub>2</sub> by using the amine process in Aspen HYSYS”.



### 2.3. Oxyfuel combustion

Despite oxyfuel combustion being a separate category of carbon capture technologies, carbon dioxide capture also occurs post-combustion in the oxyfuel combustion process. The key difference is that, in oxyfuel combustion, the combustion of the fuel occurs in an atmosphere of pure, or almost pure (over 90%), oxygen (Z. Wu et al., 2023; Baukal, 2013; Raho et al., 2022). The rest of gases in the combustion medium can be recirculated flue gases (Raho et al., 2022; Bandilla, 2020; Talei et al., 2024). The oxyfuel combustion process results in a flue gas with 80% to 98% of carbon dioxide by volume (after condensation of water) (Z. Wu et al., 2023; Talei et al., 2024), which is a much higher CO<sub>2</sub> concentration in comparison with flue gases emitted by combustion with regular air (Raho et al., 2022; Talei et al., 2024). The higher concentration of carbon dioxide in the flue gas leads to a significantly less expensive, and more energy efficient, CO<sub>2</sub> separation process (Talei et al., 2024; Bandilla, 2020).

However, oxyfuel combustion requires significant additional equipment. For example, a cryogenic air separation unit (ASU) is required to provide oxygen for the process (Raho et al., 2022; Stanger et al., 2015) in addition to the usual post-combustion carbon capture equipment. The current electricity generation units (Wärtsilä 12V34DF gensets) are probably not compatible with pure oxygen combustion. Introducing pure oxygen to an area with a potentially explosive atmosphere hazard, such as a floating LNG terminal, is also difficult. All this makes oxyfuel combustion carbon capture a difficult technology to retrofit onto some existing plants, such as a floating LNG terminal with limited space on-board and onshore.

Since it is likely not economically, or technically, feasible to retrofit the oxyfuel combustion carbon capture method at the Croatian LNG terminal, it is not going to be considered for the carbon capture project at the LNG terminal.

## **2.4. Other technologies**

There are also many other technologies used to capture carbon dioxide, such as cryogenic carbon capture (Air Liquide, n.d.) and membranes (Olabi et al., 2023), but describing other technologies is beyond the scope of this thesis.

### **3. POSSIBLE UTILIZATIONS OF THE CAPTURED CO<sub>2</sub>**

There are numerous uses of CO<sub>2</sub> in many industries today. The International Energy Agency (IEA) reports that around 230 million tonnes (Mt) of CO<sub>2</sub> are used every year globally (IEA, 2019b).

Any carbon capture process with a utilization of the captured carbon dioxide is called Carbon Capture and Utilization (CCU) (Desport and Selosse, 2022). In case the captured CO<sub>2</sub> is exclusively stored underground (geological storage), the process is called Carbon Capture and Storage (CCS). In case the CO<sub>2</sub> is used for an enhanced oil recovery (EOR) project in the oil and gas industry, the process is called Carbon Capture, Utilization, and Storage (CCUS). It might be possible to use the captured CO<sub>2</sub> both industrially and for EOR at the same time, in which case the process is still called CCUS. There is a debate as to the proper name of each procedure in terms of the length of sequestration and origin of the carbon dioxide (Desport and Selosse, 2022), but such considerations are beyond the scope of this thesis.

Carbon dioxide purity requirements for some uses are: 95% and above for enhanced oil recovery (EOR) (Topham et al., 2014; Ho et al., 2019), 99.9% for urea production (Ho et al., 2019), 99.95% for laser applications (CO<sub>2</sub>Meter, 2024), 99.5% for medical uses (CO<sub>2</sub>Meter, 2024), 99% for refrigeration (Ho et al., 2019), only 6% and above for mineral carbonation (Ho et al., 2019), 99.999% for research purposes (CO<sub>2</sub>Meter, 2024), and 99.5% for industrial uses (CO<sub>2</sub>Meter, 2024). Regarding the food and beverage industry in the EU, the carbon dioxide purity standard is set at 99% by the European Commission in the Commission Regulation (EU) No 231/2012 of 9 March 2012 laying down specifications for food additives listed in Annexes II and III to Regulation (EC) No 1333/2008 of the European Parliament and of the Council (OJ, Series L 2012/083, 22.3.2012). However, the EU specification also limits the concentration of other impurities (i.e. carbon monoxide and oil) and prescribes tests for other properties (e.g. acidity). Industry associations, like the European Industrial Gases Association (EIGA), the Compressed Gases Association of America (CGA), and the

International Society of Beverage Technologists (ISBT), together set higher quality standards in official recommended good practices for the food and beverage industry (i.e. purity of at least 99.9% v/v and other criteria) (Brownsort, 2019; European Chemicals Agency, 2014).

Carbon dioxide mixture purities (also known as grades) in the industry are designated with decimal numbers, such as 3.5, 4.5, 5.0, etc. The first digit represents the number of nines in the purity percentage, under the condition that the first two nines represent the “99%”, after which comes the decimal point and the rest of the nines. The second digit represents the first number after the last nine in the purity percentage. Therefore, carbon dioxide of grade 4.5 signifies a 99.995% purity of the CO<sub>2</sub> mixture (BOC Limited, n.d.). The technical and economical assessment of the potential carbon capture and purification process in this thesis also aims to show it is possible to achieve such purities with a carbon capture process from flue gases at an economical price for further utilizations. Utilizations provided in this chapter are by no means a complete list and they are meant only to showcase the numerous possible usages of the captured CO<sub>2</sub>. Additionally, the potential cost and economic benefit of a CCS project is investigated in the following subchapter.

### **3.1. Potential cost and economic benefit of carbon capture and storage (CCS)**

Since there is no industrial use of carbon dioxide that is only stored underground, CCS is a pure cost operation. However, companies decide to conduct CCS investments in order to avoid possibly larger future costs of CO<sub>2</sub> emission allowances, such as in the Emissions Trading System (ETS) of the European Union (EU). There is currently not a nationwide ETS in the United States of America (USA), but there are mandatory CO<sub>2</sub> emission allowances trading systems in several states (Regional Greenhouse Gas Initiative, n.d.; International Carbon Action Partnership, n.d.; California Air Resources Board, n.d.; Greenhouse Gas Management Institute and Stockholm Environment Institute, n.d.). With CCS, the price of carbon dioxide emissions for the company has been locked-in (hedged) for the duration of the storage operation. The price of CCS projects depends on many different factors,

especially on the content of carbon dioxide in the feed gas, from which CO<sub>2</sub> needs to be extracted. For feed gases with a higher content of carbon dioxide, the cost of CCS is generally lower per tonne of captured CO<sub>2</sub> than for feed gases with lower content of carbon dioxide. For example, the price of capture is lower for ammonia, ethanol, and natural gas processing plants than the price of capture for power plants, steel mills, and cement factories (International Institute for Sustainable Development [IISD], 2023; Leeson et al., 2017; Global CCS Institute, 2021; IEA, 2021; Mahapatra, 2023). Other major cost factors for CCS projects are the technology used for capture, the transportation method and distance, availability of pre-existing pipelines, the location of the storage (injection) site (continental or offshore), and whether already-existing boreholes can be used or new ones should be drilled (IEA, 2021; Irlam, 2017; Moch et al., 2022; Schmelz et al., 2020; Markov, 2022). Important cost factors within solvent-based capture technologies are the solvent used, solvent concentration, and the source of energy for solvent regeneration (Orangi, 2021; Moch et al., 2022; Y. Wu et al., 2022; F. Wang et al., 2017). Optimal selection of the source of energy for solvent regeneration is a current topic of research in the field of carbon capture (Y. Wu et al., 2022; F. Wang et al., 2017; Van Wagener et al., 2013; Quang et al., 2023). The cost of CCS projects is also subject to lower unit costs with economies of scale, more advanced and optimised processes, as well as shared infrastructure (e.g. CCS networks) (Clean Air Task Force [CATF], 2023b; IEA, 2021; Moch et al., 2022; Global CCS Institute, 2021).

In Canada, the cost to date of the Quest CCS project has been estimated to 200 CAD/tCO<sub>2</sub> in 2021, although the total cost per tonne of CO<sub>2</sub> captured at the end of the project should be around 60 CAD/tCO<sub>2</sub> (The Globe and Mail, 2021; IISD, 2023). The estimated cost for the Boundary Dam project in Canada, a coal power plant retrofit, is 100 – 120 CAD/tCO<sub>2</sub> (IISD, 2023; Robertson and Mousavian, 2022). A 2023 study estimated the cost of a retrofit CCS project on a natural gas power plant at an oilsands facility in Canada to range from 111 CAD/tCO<sub>2</sub> to 144 CAD/tCO<sub>2</sub> (IISD, 2023; MacDougall et al., 2023).

A policy brief at the Harvard Kennedy School in 2022 gathered carbon capture cost estimates from various reports for several industries in the US and concluded the following cost ranges for particular industries: 22 – 32 USD/tCO<sub>2</sub> for ammonia production, 19 – 205 USD/tCO<sub>2</sub> for cement production, 20 – 132 USD/tCO<sub>2</sub> for coal-fired power plants, 26 – 36 USD/tCO<sub>2</sub> for ethanol production, 49 – 150 USD/tCO<sub>2</sub> for natural gas power plants, 65 – 136 USD/tCO<sub>2</sub> for hydrogen production, and 8 – 133 USD/tCO<sub>2</sub> for steel mills (Moch et al., 2022). These figures do not include transportation and storage costs. The brief gathered costs of 12 USD/tCO<sub>2</sub> for compression prior to pipeline transport, 15 USD/tCO<sub>2</sub> for pipeline transport, and 11 USD/tCO<sub>2</sub> for storage from literature (Moch et al., 2022).

An IEA commentary in 2021 declared that carbon capture costs can vary from 15 – 25 USD/tCO<sub>2</sub> for industries with a high CO<sub>2</sub> concentration in the feed gas and 40 – 120 USD/tCO<sub>2</sub> for industries with a lower CO<sub>2</sub> concentration in the feed gas (IEA, 2021). The same IEA commentary also declared a range of 2 – 14 USD/tCO<sub>2</sub> for onshore pipeline transport in the US and declared the cost spread of onshore storage is greater, although “*more than half of onshore storage capacity is estimated to be available below 10 USD/tCO<sub>2</sub>*” (IEA, 2021).

A 2020 modeling study of the cost of potential CCS projects in northeastern and midwestern US concluded that carbon dioxide emissions from regional coal power plants can be captured, transported, and stored onshore in the region for 52 – 60 USD/tCO<sub>2</sub>, while the cost of CCS projects for carbon dioxide emitted from natural gas power plants in the region would range from 80 – 90 USD/tCO<sub>2</sub>. In case of offshore storage, the study concluded this would bring lowest CCS project costs to over 60 USD/tCO<sub>2</sub> for carbon dioxide from coal power plants, but also concluded that offshore storage for CCS projects in the region should not be needed unless certain conditions prescribe it (Schmelz et al., 2020).

However, a CRU Group report in 2023 indicated that a carbon dioxide emission allowance price of 200 USD/tCO<sub>2</sub> would be needed in order for coal power plants with CCS

projects to be competitive with unabated coal power production under current prices of CCS projects and assumptions laid out in the report. The same figure was determined to be 180 USD/tCO<sub>2</sub> for natural gas power plants. The report also indicates that the cost of CCS projects should fall in the future with experience and, therefore, a CO<sub>2</sub> emission allowance price of 125 USD/tCO<sub>2</sub> would be needed for the same purpose. The report states that CCS project costs are often misquoted and that published figures typically do not account for the full costs (Butterworth, 2023).

An interactive tool was published in 2023 by the Clean Air Task Force organisation, which provides a visualisation of cost estimates for potential CCS projects in every member state of the EU and the UK for emitters with more than 100,000 tonnes of carbon dioxide emissions per year (CATF, 2023b; CATF, 2023a). The tool presents the highest and lowest cost figures for two scenarios: 1) pipeline transport or not, and 2) only currently planned storage sites or all potential storage sites with over 100 Mt of CO<sub>2</sub> capacity. The tool also provides a breakdown of the cost with respect to capture costs and transportation & storage costs. For included emitters near the LNG terminal (Thermal power plant Plomin and Plomin 2, Rijeka refinery, and Koromačno cement factory), the scenario with all potential storage sites and pipeline transport was selected to view estimated cost figures. The overall cost estimation for these plants ranges from 75 EUR/tCO<sub>2</sub> to 145 EUR/tCO<sub>2</sub>. Transportation & storage costs are estimated at 20 EUR/tCO<sub>2</sub> for each plant and these are included in the overall cost estimation. The estimated amount of “capturable” CO<sub>2</sub> for entire Croatia, provided by the tool and for the same scenario, is 6 Mtpa with an average lowest cost of 78 EUR/tCO<sub>2</sub> and an average highest cost of 136 EUR/tCO<sub>2</sub> across all included emitters (CATF, 2023a).

The Foundation for Industrial and Technical Research (SINTEF) from Norway has published an article in 2019 in which it estimates that the cost of CCS projects for coal power plants with over 1 Mtpa CO<sub>2</sub> capture capacity is going to be approximately 93 USD/tCO<sub>2</sub> under laid out assumptions in the long term (Benjaminsen, 2019). The Longship project in

Norway aims to capture carbon dioxide from a Norcem cement factory and Fortum waste-to-energy plant in Oslo, transport it in liquid form by ships (CO<sub>2</sub> tankers) to a receiving terminal and transport it by a sub-sea pipeline to an offshore storage location in the North Sea (ccsnorway.com, 2022; Redep, 2021). The Longship CCS project was estimated to cost 1810 NOK/tCO<sub>2</sub> for Fortum and 1085 NOK/tCO<sub>2</sub> for Norcem in early 2020 (Killingland et al., 2020), while a unique cost of 1280 NOK/tCO<sub>2</sub> was estimated in late 2020 as per report of Gassnova published later in the same year, with predicted cost reductions in the future (ccsnorway.com, 2022).

Overall, the price of CO<sub>2</sub> emission allowances in the EU ETS peaked at over 105 EUR/tonne in February 2023. Since peaking in 2023, the allowance price has declined to 69 EUR/tonne (January 15<sup>th</sup> 2024), although it spent most of the time from December 2021 to December 2023 between 80 EUR/tonne and 100 EUR/tonne (tradingeconomics.com, 2024; Ember-climate.org, 2024). At such market prices and price volatility, the economic benefit of a CCS project for power plants is currently not guaranteed in the near term.

### **3.2. Utilizations in the oil and gas industry: EOR, EGR, and gas lift**

#### **3.2.1. EOR**

An already established and conventional utilization of CO<sub>2</sub> is Enhanced Oil Recovery (EOR) (Farajzadeh et al., 2020; Hepburn et al., 2019; Arnaut et al., 2021). EOR is a tertiary recovery method of crude oil and it is a technology in which the objective is to increase or sustain production from a crude oil reservoir for as long as possible by applying certain methods. In essence, application of EOR technology is achieved by “*increasing the pressure difference between the reservoir and production wells or by increasing the mobility of the crude oil by reduction of the oil viscosity or by decreasing of the interfacial tension between the displacing fluids and oil*” (Donaldson et al., 1989). Obviously, there are several EOR methods for different cases (Demirović, 2016; Vuković, 2019; Thomas, 2007), but carbon dioxide gas injection is one of the most applied EOR methods (Alvarado and Manrique, 2010; Alamooti and Malekabadi, 2018; Soliz et al., 2022).



### 3.2.1.1. *Sources of carbon dioxide*

Carbon dioxide used for EOR projects can come from various sources. In the USA, it has historically come mostly from natural carbon dioxide underground deposits, which is a consequence of specific economical, technical, and geological opportunities in the country (Alvarado and Manrique, 2010; IEA, 2019a). However, such sourcing of CO<sub>2</sub> is incompatible with using EOR for sequestration of anthropogenic CO<sub>2</sub> emissions. Carbon dioxide for EOR projects can also come from industrial processes (NETL, n.d.-b; IEA, 2020; Ćatić, 2021; Markov, 2022) and natural impurities in produced crude oil or natural gas at nearby production fields (IEA, 2020; Ćatić, 2021). For example, the Croatian EOR project, which started operation in 2015, uses carbon dioxide from produced natural gas separated at the Molve Central Gas Station (Novak, 2015; Markov, 2022). Therefore, carbon dioxide from a carbon capture project can be used for EOR projects. This study will not specifically examine the possibility of using carbon dioxide for CCS and/or EOR projects in Croatia, or nearby, since there are already several publications analysing the possibility for such projects in Croatia, such as Markov (2022), Turk (2023), Oberoi Dražić (2023), Brezovac (2021), Franki et al. (2019), Vulin et al. (2023), and Arnaut et al. (2021). However, it could be a topic of a future integrated assessment based on this thesis.

### 3.2.2. EGR

Enhanced Gas Recovery (EGR), where carbon dioxide can be injected for improved recovery of natural gas, has also been investigated over the past decade with promising perspective (S.-Y. Liu et al., 2022; Hamza et al., 2021; Kružić, 2021).

### 3.2.3. Gas lift

Another common usage of carbon dioxide in the oil and gas industry is the gas lift, as one of the artificial lift methods in production of crude oil. In essence, the CO<sub>2</sub> is directly injected into the borehole at a certain point above the production interval in order to lower the density of the produced fluid column, among other effects, thereby reducing the “flowing bottomhole pressure”. This increases the pressure difference (the “drawdown”) between the

reservoir pressure and the flowing bottomhole pressure, which causes an increase in the inflow of fluids from the reservoir into the borehole and to the surface (an increase in the production of crude oil) (Liović, 2021; Perković, 2021; Nguyen, 2020; Brkić, 2020).

### **3.3. Direct (“non-conversion”) utilizations of carbon dioxide**

Carbon dioxide is used for cooling of large industrial spaces, such as supermarkets. As a refrigerant in the heating, ventilation, air conditioning, and refrigeration (HVAC&R) industry, it is known as R744 (Dilshad et al., 2019; Mađerić et al., 2007; SINTEF, 2020). Another common use of carbon dioxide as a coolant is refrigeration of ice rinks (Vidović, 2018).

CO<sub>2</sub> can also be used for cooling of food and drinks in transport (Atlas Copco, n.d.; Universal Industrial Gases, n.d.; Linde, n.d.-a; Linde, n.d.-g; Linde, n.d.-d). Carbon dioxide is useful for protection of agricultural products from pests during storage (e.g. in silos) as a fumigation technique (Atlas Copco, n.d; Linde, n.d.-f). CO<sub>2</sub> is also used in food packaging processes, namely Modified Atmosphere Packaging (MAP) and Controlled Atmosphere Storage (CAS), owing to its bacteriostatic properties (Floros and Matsos, 2005; Linde, n.d.-h). In the food and drinks industry, it has numerous other uses, such as gas stunning of animals (controlled atmosphere stunning or CAS) (Sindhøj et al., 2021; Linde, n.d.-c), drinks aeration or carbonization (Linde, n.d.-b; Steen and Ashurst, 2006), atmosphere modifications in greenhouses to increase crop yields (Y. Li et al., 2018; Waggoner, 1994; Linde n.d.-e), conserving wine (Linde, 2017a), etc. CO<sub>2</sub> can also be used as a propellant for draft beer dispensing systems (M. J. Lewis and Young, 2001; James O2, n.d.; Kosin et al., 2012) and as a propellant in aerosol cans and air guns (Linde, n.d.-a).

In medicine and the pharmaceutical industry, carbon dioxide can be used for cooling of materials in transport or storage, such as medicines, vaccines, milk (Children’s Hospital of Philadelphia, n.d.; Hahn et al., 2018), tissue or blood samples, and tissues for transplant (Linde n.d.-a; ACP, 2014; Nippon Gases, 2023; Rooney et al., 2015; Pavlić, 2021; National

Health Service, 2023; Meneghel et al., 2020). As such, CO<sub>2</sub> is often used in its solid form, which is known as dry ice. Dry ice is solid carbon dioxide, which turns directly into vapour (sublimes) at a temperature of around -78.5°C and at normal pressure (101,325 Pa) (Encyclopaedia Britannica, 2024b; Span and Wagner, 1996). Organs for transplant are kept above water ice formation temperatures (Taylor et al., 2019; J. Chen et al., 2023; Michel et al., 2015), so dry ice cannot be used for storage or transportation of organs. Nevertheless, research into cryopreservation of organs is underway (Cornwall, 2023; de Vries et al., 2019), which could pave a way for such usage of dry ice in the future (Arav, 2022; Bhattacharya, 2018; GIBIOMED, 2016).

Whole blood (WB) and blood products for transfusion are usually stored at a range of temperatures above 2°C (Veselko, 2016; Žižak, 2019; Martić, 2014). However, some blood products (e.g. cryopreserved red blood cells, fresh frozen plasma, cryopreserved platelets, cryoprecipitate) and some blood research samples are stored at much lower temperatures and can be transported using dry ice for temperature control (Henkelman et al., 2014; nbtc.naco.gov.in, n.d.; Weinberg et al., 2009; Valeri and Ragno, 2006; Bohoněk, 2012; Noorman et al., 2016).

In medicine, aside from cooling, carbon dioxide is also used in surgery (e.g. for insufflation in laparoscopic surgery) (Power et al., 2012), cryotherapy (Chircop and Formosa, 2015; gasworld, 2023), carboxytherapy (Drogovoz et al., 2021; Bagherani et al., 2023), etc.

In physics, a carbon dioxide laser was one of the first gas lasers to be invented and it finds applications in numerous industries (Duley, 1976; Niemz, 2019). Carbon dioxide also has applications in semiconductor manufacturing (e.g. photolithography, chemical vapour deposition of silicon dioxide, and cleaning) (Stockman, 2016; Google Patents, 2005; Linde, n.d.-a) and further potential uses in microelectronics manufacturing, such as described by Supekar and Skerlos (2014), Zh. Zhu et al. (2019), and Weibel and Ober (2003). In welding, it is used as a shielding gas for protection of the weld from atmospheric contamination (Kah and Martikainen, 2012). CO<sub>2</sub> is also used in fire extinguishers, mainly for fires involving

electrical equipment and combustible liquids (Jurić, 2021; Yuan et al., 2021). It is used in supercritical fluid extraction (SFE) (Machado et al., 2013; Apeks Supercritical, 2019; Kosir, 2017), which has applications in decaffeination (Marco et al., 2017; Zobot, 2020), fragrance and perfume production (Capuzzo et al., 2013; Air Source Industries, 2023), essential oils production (Milner et al., 1997; Kosir, 2017), etc., as well as potential applications in the pharmaceutical industry (Long et al., 2019), among others.

Carbon dioxide is necessary for explosive atmosphere inerting and oxidation prevention (CEN/TR 15281:2022; Mačković, 2012; Žilić, 2017). Furthermore, it is used in quarrying and mining operations in compressed (liquid or supercritical) form for rock-breaking instead of the conventional blasting powder (YongBo et al., 2018; Y. Zhang et al., 2022; B. Wang et al., 2022; Linde, n.d.-a). In metrology, CO<sub>2</sub> is used for calibration of certain gas analysers (Cecelski et al., 2022; Krizmanić, 2016; Air Liquide, 2024; Metroalfa, 2022; ISO 6141:2015).

Carbon dioxide is also used for pH control as a neutralizing agent (Galès et al., 2020; Linde, n.d.-a; Linde, 2024) and in production of paints and varnishes (Desport and Seloše, 2022; Linde, n.d.-a). Carbon dioxide is used for cleaning purposes (“CO<sub>2</sub> cleaning”), such as in the “dry-ice blasting” method (Electric Power Research Institute, 2002; Chai et al., 2022; Linde, n.d.-a; Kohli, 2019). Furthermore, dry ice is used for creating special effects in the entertainment industry (Chai et al., 2022), for trapping mosquitoes (Jović, 2016; Jović, 2017; Takahashi and Hasuda, 2021), and even as an insect anesthetic in research laboratories (Chai et al., 2022), among other uses.

These have mostly been direct (or non-conversion) uses of carbon dioxide. There are also numerous conversion (or indirect) utilizations, where carbon dioxide is used as a feedstock (or a reactant or a co-reactant) and transformed into a certain valuable end-product (Desport and Seloše, 2022), which are presented in the following subchapter.

### 3.4. Indirect (“conversion”) utilizations of carbon dioxide

#### 3.4.1. Mineral carbonation

Carbon dioxide can be utilized with the process of carbon dioxide mineralization, also known as mineral carbonation or CO<sub>2</sub>-to-carbonates, which produces compounds called carbonates (Topham et al., 2014; Desport and Selosse, 2022). Carbonates are, for example, utilized in the production of construction materials, such as cement and concrete. A novel, but already proven, utilization of CO<sub>2</sub> in the construction industry is the curing of concrete by injecting water and CO<sub>2</sub> into the cement in order to enhance its strength and durability (Desport and Selosse, 2022; N. Li et al., 2022; Hepburn et al., 2019). Carbonate minerals have applications in production of fertilizers, paints, adhesives, cosmetics, and ceramics (Desport and Selosse, 2022). Carbonates can also be applied in enhanced weathering, also known as accelerated limestone weathering, as a CCUS technology and to combat ocean acidification (Chai et al., 2022; Hepburn et al., 2019).

It should be noted that the advantage of mineral carbonation is that the carbon dioxide can even be used directly from the flue gas, without purification of the mixture (Desport and Selosse, 2022; Ho et al., 2019). This means it is possible to utilize the captured CO<sub>2</sub> for carbonation without desorption from the absorbent (Chai et al., 2022; Kosaka et al., 2022). For example, if calcium hydroxide (Ca(OH)<sub>2</sub>) is used as an absorbent, it reacts with CO<sub>2</sub> to form calcium carbonate (CaCO<sub>3</sub>), a compound directly used in several industries (Chai et al., 2022). Such a process is called “*direct CO<sub>2</sub> utilization after absorption*” (Chai et al., 2022; Ho et al., 2019) or CO<sub>2</sub> capture and reduction (CCR) (Kosaka et al., 2022) or integrated CO<sub>2</sub> capture and utilization (ICCU) (Kosaka et al., 2022). This removes the necessity for CO<sub>2</sub> desorption and solvent regeneration processes, therefore significantly lowering the energy consumption and, consequently, the cost of the process, although it is not possible or profitable in all types of processes and it hasn’t been described for amine solvents (Ho et al., 2019; Desport and Selosse, 2022). Chai et al. (2022) describes that laboratory results for such processes do not necessarily translate to pilot plants or to the industrial scale and that processes should undergo pilot plant trials before large-scale applications. An example is

stated where CO<sub>2</sub> capture efficiency, with CaCO<sub>3</sub> as the absorbent, is as high as 97% in the laboratory, while the efficiency for the same process is reduced to 21% in pilot or industrial plants (Chai et al., 2022). Such discrepancies in outcomes of technology scaling signify the need for a clear indication of a technology readiness level (TRL) in research articles for greater clarity with respect to the current applicability of described technologies, in order to avoid a skewed perception as to the difficulty of the global CO<sub>2</sub> emissions abatement challenge.

#### 3.4.2. Chemicals, fertilizers, plastics, and polymers

Carbon dioxide can be utilized for production of chemicals, plastics, polymers, and fertilizers (Desport and Selosse, 2022; Topham et al., 2014). Notable chemicals produced with carbon dioxide are methanol and salicylic acid (Desport and Selosse, 2022). Granted, carbon dioxide is only used to a minor degree in the conventional methanol production process (Topham et al., 2014; Hepburn et al., 2019), but another process utilizing strictly CO<sub>2</sub> has been proposed and successfully operated in pilot and commercial industrial plants (Hepburn et al., 2019; IEA, 2019b). A notable example is an Icelandic CO<sub>2</sub>-to-methanol plant (IEA, 2019b; Hepburn et al., 2019; Topham et al., 2014). However, the profitability of such a process is currently not guaranteed in most parts of the world, since commercial CO<sub>2</sub>-to-methanol plants make use of certain geographical advantages (e.g. abundant availability of cheap renewable energy), which largely contribute to the positive net-present-value of these projects (Hepburn et al., 2019; IEA, 2019b; Desport and Selosse, 2022; Topham et al., 2014). Methanol can be used as a fuel, but it is also the basis of numerous chemical products (Desport and Selosse, 2022; Hepburn et al., 2019). Salicylic acid, having numerous medicinal properties, has been produced commercially with carbon dioxide since 1890 (Topham et al., 2014). Cyclic carbonates, obtained by a reaction of carbon dioxide and epoxides, are important because they are used as electrolytes in lithium ion batteries (Topham et al., 2014; Pescarmona, 2021).

Carbon dioxide can be utilized in production of polymers directly or indirectly (Desport and Selosse, 2022; Topham et al., 2014). Indirect utilization includes production of chemicals which are precursors to different polymers. Some of these chemicals, e.g. ethylene and propylene (olefins), are also used for their other derivatives, which provides an even broader utilization of carbon dioxide (Desport and Selosse, 2022; Topham et al., 2014). Direct utilization includes a reaction (copolymerization) of carbon dioxide with other compounds to produce polymers (or, more correctly, copolymers), some of which are even biodegradable (Topham et al., 2014; Ballamine et al., 2022). Such processes have already been commercialized for years by various companies to produce polycarbonates and polyether polycarbonate polyols (Desport and Selosse, 2022; Topham et al., 2014; IEA, 2019b). Polycarbonates have applications in packaging films, insulation, the automotive industry, data storage, electronics, biomedical materials, etc. (Topham et al., 2014; Desport and Selosse, 2022; Ballamine et al., 2022). New research also aims to expand the scope of polymers commercially producible with carbon dioxide (European Commission, 2024a; IEA, 2019b; Ballamine et al., 2022; Pescarmona, 2021).

One of the largest uses of carbon dioxide is the production of urea. Urea is one of the main nitrogen fertilizers and it even comprises about 70% of global fertilizer production (Desport and Selosse, 2022). It is also the activity that uses up the most carbon dioxide out of all carbon dioxide utilization pathways (150 Mtpa) (Desport and Selosse, 2022; Topham et al., 2014; Hepburn et al., 2019). It should be noted that urea fertilizer production is criticized as a CCU approach as it is only a short term sequestration of CO<sub>2</sub> (Desport and Selosse, 2022). However, urea is also a raw material and a catalyst in production of many polymers, such as urea-formaldehyde resin (with applications as an adhesive and a slow-release fertilizer) (Encyclopaedia Britannica, 2019; Guo et al., 2018) and polyurethane (an important insulator, among other uses) (Ballamine et al., 2022; Google Patents, 1978; Google Patents, 1979; Somarathna et al., 2018; Akindoyo et al., 2016).

### 3.4.3. Fuels and e-fuels

Carbon dioxide can be utilized for production of fuels. Fuels produced by mixing carbon dioxide and hydrogen (which is obtained by electrolysis from water) are called electrofuels (Brynnolf et al., 2018; Ridjan et al., 2016). Electricity is the primary source of energy for their production (Brynnolf et al., 2018; Airbus, 2021b). These are also known as e-fuels or synthetic fuels. It is preferable that the electricity for electrolysis comes from renewable sources, since production of the fuel would be more CO<sub>2</sub>-intensive otherwise. Therefore, these fuels can be used as excess renewable energy storage as well. The production process is usually called Power-to-liquids or Power-to-gas, although this is usually the name of the fuel as well (Airbus, 2021b; Brynnolf et al., 2018; Desport and Selsosse, 2022). A number of gaseous and liquid fuels can be produced from carbon dioxide and hydrogen, such as methanol, methane, diesel, and gasoline (Hepburn et al., 2019; Brynnolf et al., 2018; Desport and Selsosse, 2022; Topham et al., 2014). Even large car manufacturers have invested into e-fuels manufacturing plants. For example, Audi is producing blue crude, e-diesel, e-gasoline (or e-benzin), and e-gas fuels (Nady et al., 2022; Q. Zhu, 2019; Audi, 2018; Patonia and Poudineh, 2023) and it has declared it believes e-fuels will represent a significant market in the future of liquid car fuels (Electrek, 2023; Audi, 2023). Porsche has also recently started production of e-fuels by being a member of the project consortium of the Haru Oni production plant near Punta Arenas in Chile, which started e-methanol production at the end of 2022 (Porsche, 2022; Porsche, 2023; Siemens Energy, 2022; HIF Global, 2023; MAN Energy Solutions, 2023). The produced e-methanol from Haru Oni is converted into other fuels, like eGasoline, eLiquefied Gas (eLG), jet fuel, etc. (HIF Global, 2023). Some companies have taken up e-fuel production for airplanes (Nordic Electrofuel, 2022) and Airbus has already committed to achieve using 10% of Sustainable Aviation Fuel (SAF) in their commercial aircraft and helicopter internal operations during 2023 (Airbus, 2023b; Airbus, 2021b; Airbus, 2022). Airbus has also achieved flights powered with 100% SAF for both engines in its own testing programme (Airbus, 2023a; Airbus, 2021a).



There has also been modelling research into production of e-fuels, such as methane, with the purpose of balancing national energy systems containing a high share of renewable energy sources, which has indicated it is possible to achieve energy system balancing with a power-to-gas technology (Njirić, 2022). Methane, as an e-fuel, is also known as substitute natural gas or synthetic natural gas (SNG), synthetic methane, and e-methane (Hussain et al., 2021; Speight, 2020; Njirić, 2022; Gorre et al., 2019; Fonder et al., 2024).

CO<sub>2</sub> can be utilized for production of biofuels from microalgae (Z. Zhang et al., 2020; Ho et al., 2019), though the process is not yet commercially viable (Saravanan et al., 2022; Tomar et al., 2023) and there have been recent doubts as to the viability of the technology in the future (Yale E360, 2023; Tomar et al., 2023). It should be noted that the carbon dioxide for production of biofuels from microalgae can sometimes even be used directly from the flue gas, without purification of the CO<sub>2</sub> mixture (Z. Zhang et al., 2020; Zieliński et al., 2023). This means it is possible to utilize the CO<sub>2</sub> for microalgae biofuels without desorption and absorbent regeneration processes, which lowers the energy consumption and, consequently, the cost of the process.

#### 3.4.4. Geothermal energy and energy storage

Some research has suggested CO<sub>2</sub> could be used instead of water in geothermal energy production processes in order to achieve more favourable heat extraction (i.e. Enhanced geothermal systems, EGS), although there has not yet been a pilot plant of such technology to date (Pruess, 2007; Vulin et al., 2020).

It is possible to use compressed carbon dioxide as an energy storage medium, both underground and above the ground (Alami et al., 2019; Z. Liu et al., 2020; Energy Dome, 2024; Electrek, 2022), although the technology has not been widely deployed yet.

## 4. MODELING POST-COMBUSTION CAPTURE OF CO<sub>2</sub> IN ASPEN HYSYS

### 4.1. Flue gas compositions and physical properties

The amine chemical absorption process was chosen as the most viable process to be considered for this thesis and for the Croatian LNG terminal.

The composition of flue gases from electrical power production on the Croatian LNG terminal was provided by LNG Croatia. The composition of flue gases had been obtained by assessments of flue gas composition by the company Metroalfa d.o.o. in December 2020 and January 2022. Three measurements for each of the three engines were conducted in every assessment and an average of the three measurements for each engine was also provided in every assessment. Assessments were done at usual working capacities for each engine (60% load for the left engine, 55% load for the middle engine, and 50% load for the right engine). Assessments included measurements of physical properties of the flue gas streams as well.

For the work in this thesis, averages from the 2022 assessment for each engine were taken to form representative compositions and properties for modelling and simulation of the carbon capture process in Aspen HYSYS. Assessment reports provided stream compositions in mol%. Note that mol% and vol% can be used interchangeably for gases. Mass% figures were calculated automatically by HYSYS. Following tables contain the compositions and physical properties of the flue gas used for modelling and simulation (Table 4-1, Table 4-2, Table 4-3, Table 4-4, Table 4-5, and Table 4-6):

**Table 4-1** Composition of flue gas from Engine 1 (the right engine) under working conditions, 2022 assessment (Metroalfa, 2022)

Components	Unit	Value	Unit	Value
CO <sub>2</sub>	mol %	5.110	mass %	7.860
O <sub>2</sub>	mol %	12.330	mass %	13.79
N <sub>2</sub>	mol %	75.300	mass %	73.75

H <sub>2</sub> O	mol %	7.290	mass %	4.590
NO <sub>x</sub>	kg/h	2.021	Same	Same
Particulate matter (solid particles)	kg/h	0.040	Same	Same

**Table 4-2** Physical properties of flue gas from Engine 1 (the right engine) under working conditions, 2022 assessment (Metroalfa, 2022)

Parameter	Unit	Value
Pressure (absolute)	Pa	103,010
Temperature	°C	354.6
Density	kg/m <sup>3</sup>	0.5641
Volumetric Flow Rate	m <sup>3</sup> /h	27730

**Table 4-3** Composition of flue gas from Engine 2 (the centre engine) under working conditions, 2022 assessment (Metroalfa, 2022)

Components	Unit	Value	Unit	Value
CO <sub>2</sub>	mol %	5.240	mass %	8.070
O <sub>2</sub>	mol %	12.120	mass %	13.572
N <sub>2</sub>	mol %	75.100	mass %	73.623
H <sub>2</sub> O	mol %	7.510	mass %	4.735
NO <sub>x</sub>	kg/h	2.016	Same	Same
Particulate matter (solid particles)	kg/h	0.028	Same	Same

**Table 4-4** Physical properties of flue gas from Engine 2 (the centre engine) under working conditions, 2022 assessment (Metroalfa, 2022)

Parameter	Unit	Value
Pressure	Pa	103,010
Temperature	°C	349.6

Density	kg/m <sup>3</sup>	0.5678
Volumetric Flow Rate	m <sup>3</sup> /h	26,402

**Table 4-5** Composition of flue gas from Engine 3 (the left engine) under working conditions, 2022 assessment (Metroalfa, 2022)

Components	Unit	Value	Unit	Value
CO <sub>2</sub>	mol %	5.45	mass %	8.394
O <sub>2</sub>	mol %	11.78	mass %	13.191
N <sub>2</sub>	mol %	75.0	mass %	73.523
H <sub>2</sub> O	mol %	7.76	mass %	4.892
NO <sub>x</sub>	kg/h	1.785	Same	Same
Particulate matter (solid particles)	kg/h	0.029	Same	Same

**Table 4-6** Physical properties of flue gas from Engine 3 (the left engine) under working conditions, 2022 assessment (Metroalfa, 2022)

Parameter	Unit	Value
Pressure	Pa	103,010
Temperature	°C	358.1
Density	kg/m <sup>3</sup>	0.5599
Volumetric Flow Rate	m <sup>3</sup> /h	30,142

It is not possible to enter the volumetric flow rate of gases for streams in Aspen HYSYS manually, although it is possible to enter the mass flow rate (kg/hr). However, the mass flow rate is not provided by the assessment. The mass flow rate of the flue gas for each engine is, then, obtained from the volumetric flow rate by using the relationship of density, mass and volume:

$$\rho = \frac{m}{V} \quad (3-1)$$

Where m is mass in kilograms (kg), V is volume in cubic meters (m<sup>3</sup>), taken as the volume component of the volumetric flow rate, and  $\rho$  is the (measured) density in kg/m<sup>3</sup>. HYSYS calculates the stream density automatically after the stream's composition, temperature, and pressure are entered. It is also not possible to enter measured densities into stream properties, as HYSYS uses its own correlations to calculate the stream's density. However, measured densities (from the assessment by Metroalfa d.o.o), instead of calculated densities (by HYSYS), were used to obtain, and enter, mass flow rates of the streams. The result of multiplication of measured density (kg/m<sup>3</sup>) and volume (m<sup>3</sup>) provides the mass to be used for the hourly mass flow rate.

Another option is to use the following equation:

$$\text{Mass flow rate} \times \text{inverse of density} = \text{volumetric flow rate} \quad (3-2)$$

Or, in terms of units:

$$\frac{kg}{hr} \times \frac{m^3}{kg} = \frac{m^3}{hr} \quad (3-3)$$

Equation 3-2 can be rearranged to provide mass flow rate directly:

$$\text{Mass flow rate} = \text{volumetric flow rate} \times \text{density} \quad (3-4)$$

Or, in terms of units:

$$\frac{kg}{hr} = \frac{m^3}{hr} \times \frac{kg}{m^3} \quad (3-5)$$

It should be noted that the densities calculated by HYSYS do not deviate considerably from any measured densities, with the difference occurring only on the fifth, third, and second digit after the decimal point for the first, second, and third engine's flue gas density respectively. HYSYS also calculates the volumetric flow rate of gaseous streams (after the mass flow rate has been entered) as two stream properties named "Act. Volume Flow [m3/h]" and "Act. Gas Flow [ACT\_m3/h]", but these stream properties cannot be entered manually. If the vapour fraction of the stream is 1.000, meaning the stream is completely gaseous and contains no liquid fraction, the two properties should have the same value.

Using the data outlined above, the mass flow rate of the flue gas from engine 1 is calculated as 15,642.493 kg/h, the mass flow rate of the flue gas from engine 2 is calculated as 14,991.056 kg/h, and the mass flow rate of the flue gas from engine 3 is calculated as 16,876.506 kg/h. The values of mass flow rates are entered into stream conditions in HYSYS respectively and with all decimal numbers from the calculator output (not shown here).

For the "Engine 1" stream, "Act. Volume Flow [m3/h]" and "Act. Gas Flow [ACT\_m3/h]" have the same value of 27,725.744 m<sup>3</sup>/hr. For the "Engine 2" stream, "Act. Volume Flow [m3/h]" and "Act. Gas Flow [ACT\_m3/h]" have the same value of 26,367.816 m<sup>3</sup>/hr. For the "Engine 3" stream, "Act. Volume Flow [m3/h]" and "Act. Gas Flow [ACT\_m3/h]" have the same value of 30,094.687 m<sup>3</sup>/hr. These values are quite close to the volumetric flow rates provided by measurements in the tables above. The volumetric flow rates calculated by HYSYS will inevitably be somewhat different, since a different density figure is used for the calculation by HYSYS.

Since the sum of mol, and mass, fractions of components (e.g. CO<sub>2</sub>, O<sub>2</sub>, etc.) were greater than 1.00 for flue gases of all three engines (because the averages of measurements do not add up to 1.00) the normalization function was applied in the HYSYS stream composition entry form. This resulted in the following composition(s) for flue gas streams (Table 4-7, Table 4-8, and Table 4-9):

**Table 4-7** Stream composition of the flue gas from Engine 1

Components	Unit	Value	Unit	Value
CO <sub>2</sub>	mol %	5.108	mass %	7.863
O <sub>2</sub>	mol %	12.288	mass %	13.794
N <sub>2</sub>	mol %	75.277	mass %	73.751
H <sub>2</sub> O	mol %	7.288	mass %	4.592
NO <sub>x</sub>	kg/h	-	-	-
Particulate matter (solid particles)	kg/h	-	-	-

**Table 4-8** Stream composition of the flue gas from Engine 2

Components	Unit	Value	Unit	Value
CO <sub>2</sub>	mol %	5.242	mass %	8.070
O <sub>2</sub>	mol %	12.124	mass %	13.571
N <sub>2</sub>	mol %	75.123	mass %	73.623
H <sub>2</sub> O	mol %	7.512	mass %	4.735
NO <sub>x</sub>	kg/h	-	-	-
Particulate matter (solid particles)	kg/h	-	-	-

**Table 4-9** Stream composition of the flue gas from Engine 3

Components	Unit	Value	Unit	Value
CO <sub>2</sub>	mol %	5.451	mass %	8.394
O <sub>2</sub>	mol %	11.781	mass %	13.191
N <sub>2</sub>	mol %	75.008	mass %	73.523
H <sub>2</sub> O	mol %	7.761	mass %	4.892
NO <sub>x</sub>	kg/h	-	-	-

Particulate matter (solid particles)	kg/h	-	-	-
---	------	---	---	---

NO<sub>x</sub> and particulate matter (PM) were not included in the stream compositions for simulation and modelling. The reason for this is outlined below in chapter 4.2 Modelling and simulation. Temperatures and pressures were kept the same as the original values declared in the tables of physical properties above for each stream. The mixer feature was then used in HYSYS to unify the three streams into one, as it should happen in the real project, before pre-treatment and entry into the absorber. This is shown in Figure 4-1:

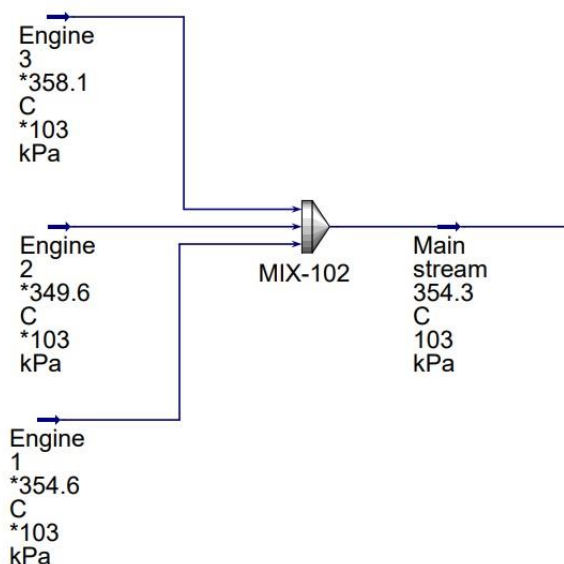

**Figure 4-1** Unification of the three streams of flue gases

The sum of mass flow rates of the three streams of flue gases is 47,510.055 kg/h, provided both by HYSYS and by summation of figures from the measurements, since it follows from the law of conservation of mass. The composition of the unified stream of flue gases has been calculated by Aspen HYSYS as shown in Table 4-10 and Table 4-11:



**Table 4-10** Composition of the unified flue gas stream under working conditions (“Main stream”)

Components	Unit	Value	Unit	Value
CO <sub>2</sub>	mol %	5.272	mass %	8.117
O <sub>2</sub>	mol %	12.069	mass %	13.510
N <sub>2</sub>	mol %	75.133	mass %	73.630
H <sub>2</sub> O	mol %	7.527	mass %	4.744
NO <sub>x</sub>	kg/h	-	-	-
Particulate matter (solid particles)	kg/h	-	-	-

And physical properties of the unified stream of flue gases have been calculated by HYSYS as:

**Table 4-11** Physical properties of the unified flue gas stream under working conditions

Parameter	Unit	Value
Pressure	Pa	103,010
Temperature	°C	354.3
Density	kg/m <sup>3</sup>	0.5643
Volumetric Flow Rate	m <sup>3</sup> /h	84,188

The same unified flue gas stream was used for all cases in this thesis. In addition, the flue gas was pre-treated with slight pressurization by a two-stage compression with two industrial high-temperature fans and cooled with a heat exchanger utilizing the seawater located at the terminal. Heat exchangers for regasification of LNG at the terminal already use seawater as the working fluid, so the potential operator is experienced with using heat exchangers which need to withstand corrosion and other possible conditions brought on by the usage of seawater (e.g. particles intrusion, erosion, scale deposits, marine life, etc.). Other types of cooling pre-treatment are also available, such as direct contact cooling described by Orangi

(2021). Cooling is necessary as the 354°C temperature (394°C after the two-stage fan compression) is too large for the chemical process in the absorber. The temperature of the main stream in this thesis is lowered to 50°C. The main stream is compressed from 103,010 Pa to 123,000 Pa in a two-stage fan compression and the stream loses 3000 Pa in the cooler (heat exchanger) to attain the final pressure of 120,000 Pa (1.2 bar) before entry into the absorber. A pump for the cooling water is also modelled to obtain the power duty (and, therefore, power supply cost) and the capital cost of the pump.

The mixing and pre-treatment process is shown in Figure 4-2:

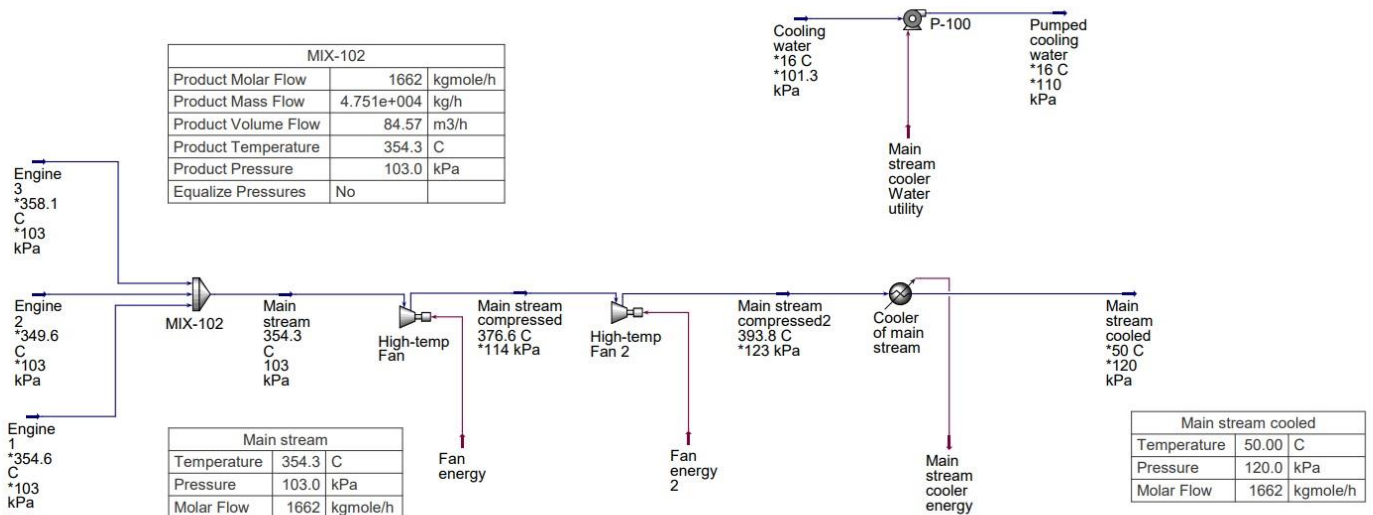

**Figure 4-2** Unification and the pre-treatment process of the flue gas

Aspen HYSYS is a widely used process simulation software used in the chemical engineering industry. It offers steady-state and dynamic process simulation, though only steady-state behaviour was studied in this thesis. HYSYS offers two main computational modes: Equilibrium (“Efficiency”) modelling and Rate-based (“Advanced”) modelling. Advanced modelling is the more rigorous method (Madeddu et al., 2017; Aspen Technology Inc, 2022) and presents much more options for the user to define. It also includes more

complex relations in its calculations, as described in detail in the HYSYS V12.1 user manual. Advanced modelling was used for both the absorber and the desorber simulations in this thesis. The choice between the two was not available in Aspen HYSYS for other pieces of equipment, as chemical reactions do not widely occur in other equipment used in the simulation.

Aspen Technology Inc., or AspenTech, offers two main chemical engineering simulations programs: Aspen Plus and Aspen HYSYS. Aspen HYSYS is primarily geared towards the petrochemical industry, while Aspen Plus is aimed at general chemical engineering (ChemEngGuy, n.d.-a; ChemEngGuy, n.d.-b). Since amine-based post-combustion carbon capture utilises the same process equipment, and fluids, as acid gas removal units at natural-gas processing plants and refineries, HYSYS already contains the equipment models and thermodynamic property packages needed for such simulations. Aspen Plus also contains the necessary properties for such a simulation, but it has a more complex interface with much more options for the user to define since it is a general chemical engineering program (Abdullah, 2023). In addition, most literature studied for this thesis used HYSYS to model post-combustion CO<sub>2</sub> capture. Therefore, the choice was made to use HYSYS instead of Aspen Plus for this thesis, as also elaborated in the introduction.

Prior to any modelling, all stream components to be used in the simulation must be chosen from the component list with a selection tool. A “Property package” must be selected next. A property package contains methods for calculation of reactions and properties of mixtures and components, specialized to a certain use case. HYSYS contains several property packages aimed at, so called, acid gas cleaning. For this thesis, the “Acid Gas – Chemical Solvents” property package was chosen, as it supports precisely the amine required for these simulations and modelling (MEA). After the selection of a property package, reaction sets are added automatically into the simulation. Once these steps are complete, the modelling work can begin.

## 4.2. Modelling and simulation

The goal in this thesis is to try to achieve around 90% (%mass) removal efficiency of CO<sub>2</sub> in the absorber and around 90% (%mass) purity of the CO<sub>2</sub> mixture at the outlet of the desorber (or, more precisely, at the outlet of the condenser of the desorber) or at the outlet of the separator coming after the condenser of the desorber. Cases with 85-95% removal efficiency (in the absorber) are commonly evaluated in literature. Around 99% CO<sub>2</sub> mixture purity is usually used in Enhanced Oil Recovery (EOR), although mixtures with somewhat less than 99% purity can also be used (Simon, 2020a; Simon, 2020b). However, purities of at least 99.5% are required for industrial uses of CO<sub>2</sub>, which are described in the next chapter. Simulation of purification to such a high level is beyond the scope of this thesis, but the procedure will be shortly described in this sub-chapter.

The objective of achieving 90% capture efficiency in the absorber, rather than 99%, is due to the exothermic reaction between CO<sub>2</sub> and an amine (i.e. the reaction releases heat) (McCann et al., 2011; Madeddu et al., 2017). The amount of heat released in the reaction of CO<sub>2</sub> and an amine (called the “heat of reaction”, “reaction heat”, the “heat of absorption” or “absorption heat”) (Mukherjee and Samanta, 2019) greatly contributes to the total heat consumption of the carbon capture process. This is so because the heat required to reverse the reaction, in order to regenerate the amine and “free” the captured CO<sub>2</sub>, is theoretically equal to the heat released during the absorption reaction (the “reaction heat”) (S. Lu et al., 2023). Since amines have a high reaction heat with CO<sub>2</sub> (Neveux et al., 2013; Z. Li et al., 2015), and other heat requirements are also present in the process as discussed in chapter “2.2.3. Process parameters”, the cost of regeneration heat is the greatest barrier towards the wide-spread utilization of the technology. Therefore, a higher capture efficiency also leads to higher costs, possibly leading to diminishing returns. Cases with a lower and a higher capture efficiency (and lower and higher regeneration energy) than the base case are also going to be examined within this thesis to test their economic feasibility.

Primary, secondary, and tertiary alkanolamines generally differ by their heat of reaction. Heat of reaction is the highest for primary amines, like MEA, while it is lesser for secondary amines and the smallest for tertiary amines (Chowdhury et al., 2009; Goto et al., 2011). However, each amine is different by its reaction selectivity towards acid gases (e.g. MDEA reacts more readily with H<sub>2</sub>S than with CO<sub>2</sub>) and by certain other properties (Nwaoha et al., 2017), so trade-offs have to be considered while choosing the amine for every application (Goto et al., 2011).

The most common method of final purification of CO<sub>2</sub> mixtures for industrial uses is liquefaction (Messer, 2023b). The CO<sub>2</sub> mixture is usually compressed in multiple stages in order to raise the liquefaction temperature of the CO<sub>2</sub> in the mixture (Knapik et al., 2018). In-between the compression stages, the mixture is cooled to liquify and separate a part of the water from the mixture. The CO<sub>2</sub> mixture should be dehydrated to a dew point of -40°C, or lower, to avoid freezing of water in heat exchangers and other equipment (White, 2002), as well to avoid corrosion and hydrate formation (Øi et al., 2022). For initial dehydration, and dehydration throughout the dehydration process before the final liquefaction of carbon dioxide, different technologies like separators, water knockout drums, molecular sieves, activated carbon, activated alumina, etc. can be used (White, 2002; Rai, 2016; Kumar et al., 2010). Mixture components like nitrogen (N<sub>2</sub>) and oxygen (O<sub>2</sub>) lower the liquefaction temperature of the CO<sub>2</sub> from the mixture, thereby causing greater cooling energy usage (Xu et al., 2012; Knapik et al., 2018; Xu et al., 2014). Therefore, higher CO<sub>2</sub> concentrations, in comparison with N<sub>2</sub> and O<sub>2</sub> concentrations, are required to achieve CO<sub>2</sub> liquefaction at a higher temperature (Goos et al., 2011; H. Li, 2008). After liquefaction, CO<sub>2</sub> is stored in insulated storage tanks under pressure (White, 2002; Meixner et al., 2013).

Generally, CO<sub>2</sub> can exist as a liquid below its critical temperature of about 31°C (critical point temperature) and above its triple point with a temperature of about -56.6°C and pressure of about 517,950 Pa (Span and Wagner, 1996; Linde, 2017b), as it can be seen in the phase diagram (Figure 4-3):

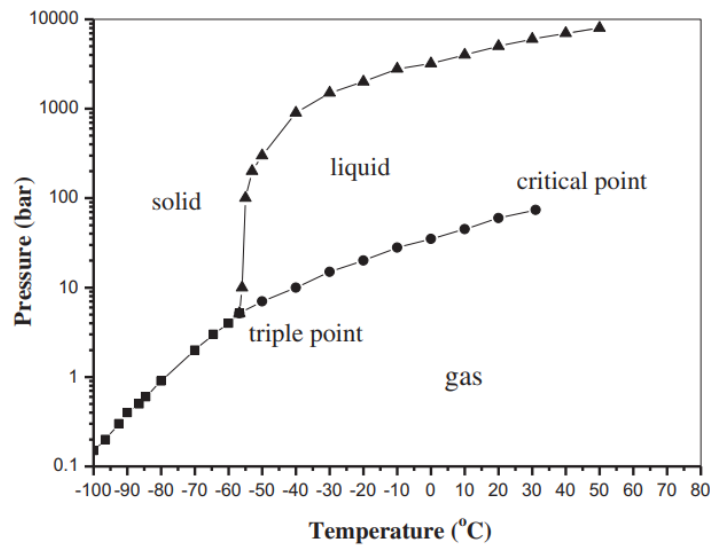

**Figure 4-3** Phase diagram of Carbon dioxide (Xu et al., 2012)

Although the term “cryogenic” is often used by the industry, and in literature, to describe such CO<sub>2</sub> separation technologies (i.e. by liquefaction), most of these processes operate at temperatures above the scientific definition of cryogenic, which is -153°C (Rufford et al., 2012).

As indicated in the flue gas composition, there are also oxides of nitrogen (NO<sub>x</sub>) and particulate matter (PM) in the flue gases. NO<sub>x</sub> compounds are NO (nitric oxide) and NO<sub>2</sub> (nitrogen dioxide), formed by nitrogen and oxygen during combustion of fossil fuels in the presence of air (Aeroqual, 2024). Particulate matter is, by definition, a term for a mixture of solid particles and liquid droplets found in the air (United States Environmental Protection Agency [EPA], 2016). In the case of flue gas from the LNG terminal, the measured PM were only solid particles. Simulation of NO<sub>x</sub> or PM removal is beyond the scope of this thesis, especially since Aspen HYSYS is not primarily aimed at simulating solids (Aspen Tech Support Center, 2022), although removal technologies will be shortly presented below and a cost estimation will be given, where available. The amount of NO<sub>x</sub> in the flue gas is 0.012254%, while the amount of PM in the flue gas is 0.000204% (of the total mass flow

rate of the flue gases, respectively). While their shares might not be relatively large, these shares are large enough to possibly warrant a removal process, if such removal is necessary in accordance with standards of a prospective utilization industry. There could also be other chemical substances present in the flue gas, but measurements were conducted only for substances stated in the composition tables. The concentration of sulfur oxides ( $\text{SO}_x$ ) in the flue gas from each engine was also measured in 2020 (expressed as sulfur dioxide,  $\text{SO}_2$ ), but the value of the mass concentrations of  $\text{SO}_2$  was only indicated as lower than  $10 \text{ mg/m}^3$  (for each engine) and the value of the mass flow rate of  $\text{SO}_2$  was only indicated as lower than  $0.176 \text{ kg/hr}$  (first engine), lower than  $0.168 \text{ kg/hr}$  (second engine), and lower than  $0.172 \text{ kg/hr}$  (third engine) (Metroalfa, 2020). No mass concentration ( $\text{mg/m}^3$ ) or mass flow rate ( $\text{kg/hr}$ ) values were reported for sulfur oxides (or sulfur dioxide) in the 2022 assessment report (Metroalfa, 2022)

$\text{NO}_x$  removal technologies can be classified into three categories: oxidation, reduction, and absorption/adsorption (Zi. Zhu and Xu, 2022). Very common industrial processes for removal of  $\text{NO}_x$  from flue gas streams are selective catalytic reduction (SCR) and selective non-catalytic reduction (SNCR). The two are largely different by their removal efficiency, which is over 90% for SCR and below 50% for SNCR (Zi. Zhu and Xu, 2022). The capital cost of an SCR system for gas turbines, or internal combustion engines, could be estimated in the range of 10 - 50 EUR/kW (based on electrical output) (Lecomte et al., 2017). Yearly operational costs have been estimated as 700 EUR per tonne of removed  $\text{NO}_x$  for an engine with an installed capacity of 20 - 50 MW(th), which operates for 4000 hours/year with an SCR system having 75% removal efficiency (Lecomte et al., 2017). A  $\text{NO}_x$ ,  $\text{SO}_2$ , and  $\text{CO}_2$  removal process integrating desalinated wastewater was proposed in 2022, which could be beneficial since the terminal could desalinate and demineralize seawater for usage in the chemical absorption process (Lim and Kim, 2022), although this also depends on the available space for such an installation.

A common method of PM removal from flue gas streams are electrostatic precipitators (ESPs) (Mizuno, 2000; Järvinen et al., 2023). ESPs function by using electrical energy (a corona discharge) to charge particles either positively or negatively. The charged particles are then attracted to collector plates with the opposite charge. ESPs can have more than 99% removal efficiencies (EPA, 2016; Mizuno, 2000). Electrostatic precipitators are widely used because of a small pressure loss, broad temperature applicability, and a high removal efficiency (Sun et al., 2020), all of which would be beneficial to this application. The capital cost of ESPs depends on their size and complexity. Main operational costs of ESPs are electricity costs, labour costs, and maintenance costs (Tomašić, n.d.-b; Tomašić, n.d.-a). A detailed guide for estimation of capital and operational costs of ESPs was published by the U.S. Environmental Protection Agency, 1999 (Turner et al., 1999). Figure 4-4 shows an electrostatic precipitator.



**Figure 4-4** Electrostatic precipitator (mechanicrealm.com, 2022)

The removal process for  $\text{NO}_x$  could be installed before entry of the flue gas into the absorber or after the flue gas exits the stripper or the separator after the stripper. Since such impurities have a potential to interact unfavourably with capture, compression, and transport



of CO<sub>2</sub>, it could be better to remove them before entry of the flue gas into the amine absorber (Sass et al., 2005). PM should be removed as a part of the pre-treatment of flue gas (Babcock & Wilcox, 2024).

NO<sub>x</sub> could also be partly spontaneously removed during the absorption process through exiting along with the clean gas at the top of the absorber or during the final liquefaction process of CO<sub>2</sub> from a mixture, as described above, although NO<sub>x</sub> compounds could also negatively affect the chemical reactions of amine absorption (Sass et al., 2005). It is also possible that particulate matter spontaneously deposits in the process equipment, but such considerations are beyond the scope of this thesis.

Since it was determined by a physical inspection of the FSRU in October 2022 that there is no room on the ship for a carbon capture amine unit, but there is space on the shore part of the terminal, a pipeline would be required to transport the flue gas from the ship's funnels to the shore. However, that consideration is beyond the scope of this thesis.

### 4.3. First case – MEA 30% concentration

The first case is modelled and simulated with a 30% MEA solution (%mass). 30% is a common concentration of MEA used in industry and described in literature regarding carbon capture (Chai et al., 2022; Jones, 2018). The process flow diagram is shown in Figure 4-5:

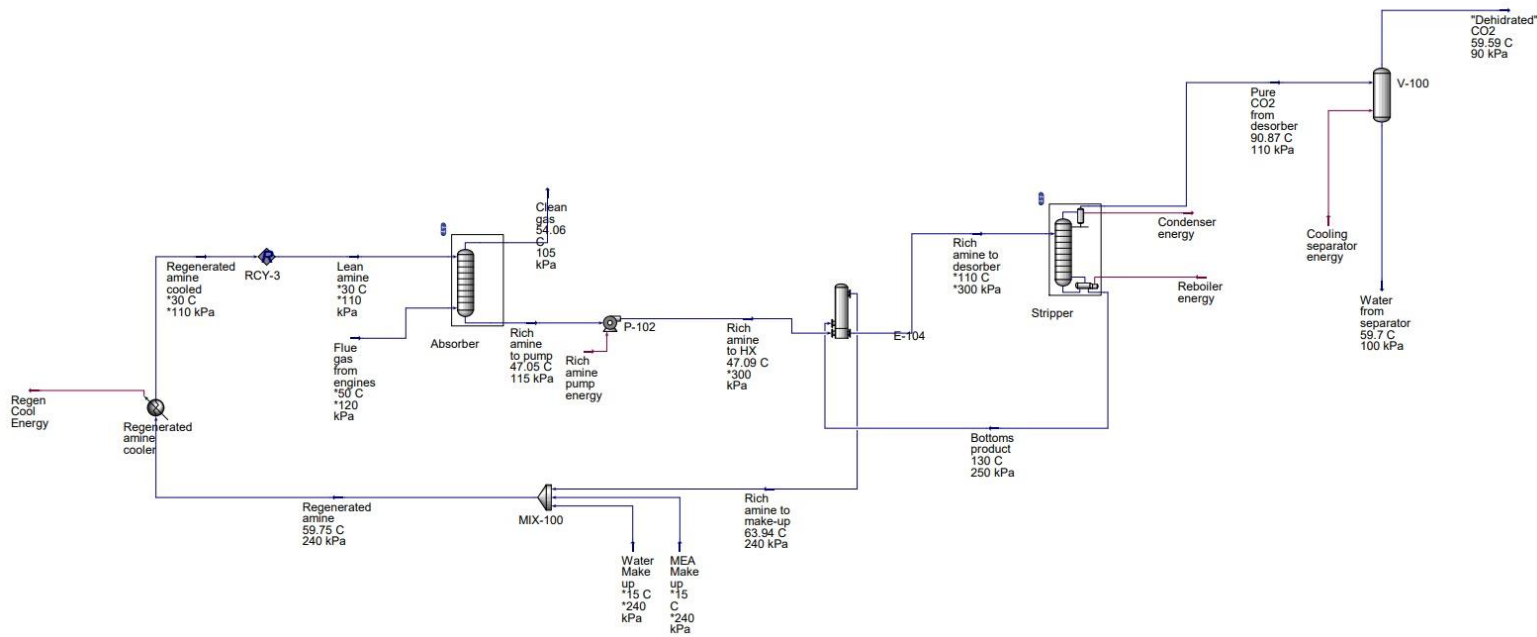

**Figure 4-5** Aspen HYSYS process flow diagram - first case

The stream “Flue gas from engines” enters the absorber with the composition as described in Table 4-10 and temperature and pressure that are a result of pre-treatment shown in Figure 4-2. The “Lean amine” stream enters the absorber with the composition and physical properties as shown in Table 4-12 and Table 4-13, respectively:

**Table 4-12** “Lean amine” stream composition

Components	Unit	Value	Unit	Value
CO <sub>2</sub>	mol %	1.921	mass %	3.600
O <sub>2</sub>	mol %	0	mass %	0
N <sub>2</sub>	mol %	0	mass %	0
H <sub>2</sub> O	mol %	86.547	mass %	66.400
MEA	mol %	11.532	mass %	30.000
Molar flow	kgmole/h	2129.343	-	-
Mass flow	-	-	kg/h	50,000

**Table 4-13** “Lean amine” stream physical properties

Parameter	Unit	Value
Pressure	Pa	110,000
Temperature	°C	30
Density	kg/m <sup>3</sup>	1044.215
Act. Volume Flow	m <sup>3</sup> /h	47.88

The absorber column uses structured packing with stage packing height of 1.000 m and the number of stages is 10. Figure 4-6 shows the absorber column design window in Aspen HYSYS.

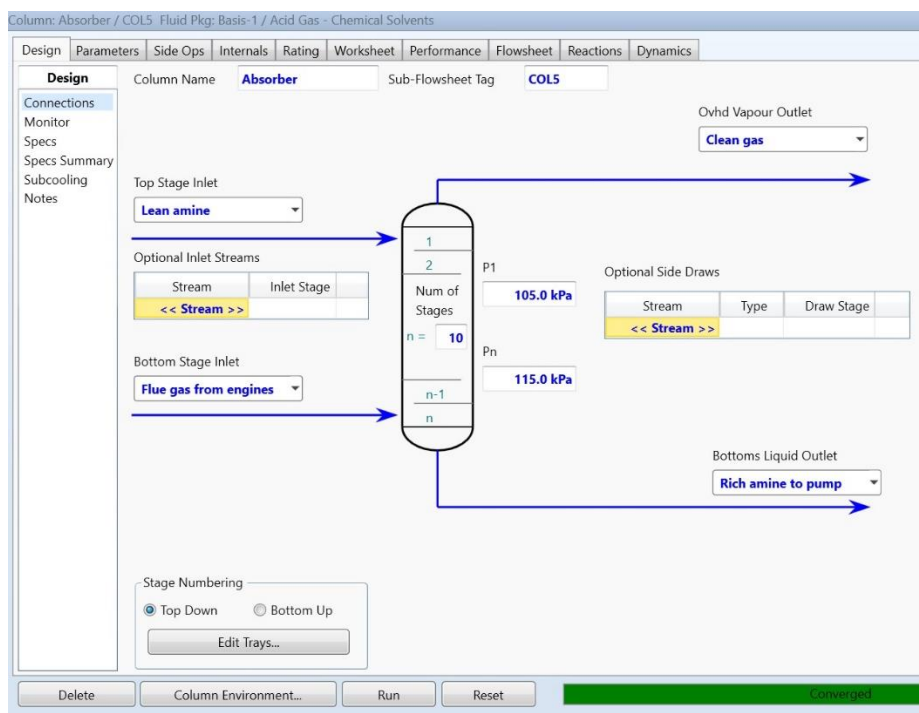

**Figure 4-6** Absorber column design window in Aspen HYSYS, “Design” tab

In the “Parameters” tab, “Advanced” (Rate-based) modelling was selected. Packing type has been selected as Mellapak, packing vendor Sulzer, packing material Plastic, and 250Y as packing dimensions. The inner diameter of the column has been chosen as 2.650 m, based on the hydraulic simulation of the column explained below. Diagnostics level was chosen as Medium.

To properly design a column, hydraulic design must also be carried out. In fact, this is where the diameter and stage packing height (and, therefore, the overall height of the column) should be modelled first, after achieving simulation convergence of the column, and only then should these parameters be entered into the “Parameters” tab. It should be noted that these settings do not carry over automatically between the two tabs. Hydraulic modelling of the column is done in the “Internals” tab of the absorber window shown in Figure 4-7:

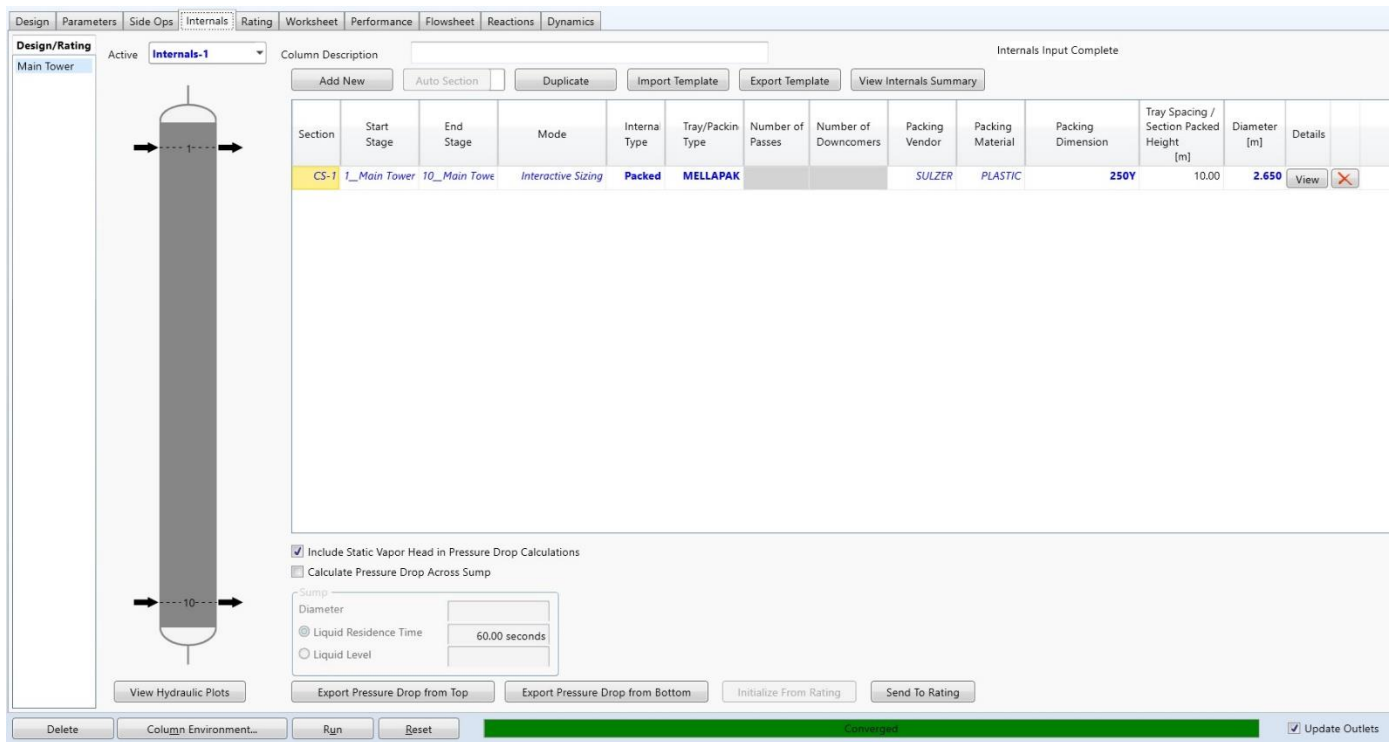

**Figure 4-7** “Internals” tab of the absorber window in Aspen HYSYS

After adding all 10 stages as one “Section” and choosing the packing parameters, column diameter, and stage packing height, one can see the hydraulic plots by clicking on the “View Hydraulic Plots” button. Optimized column hydraulics for this case look as shown in Figure 4-8:

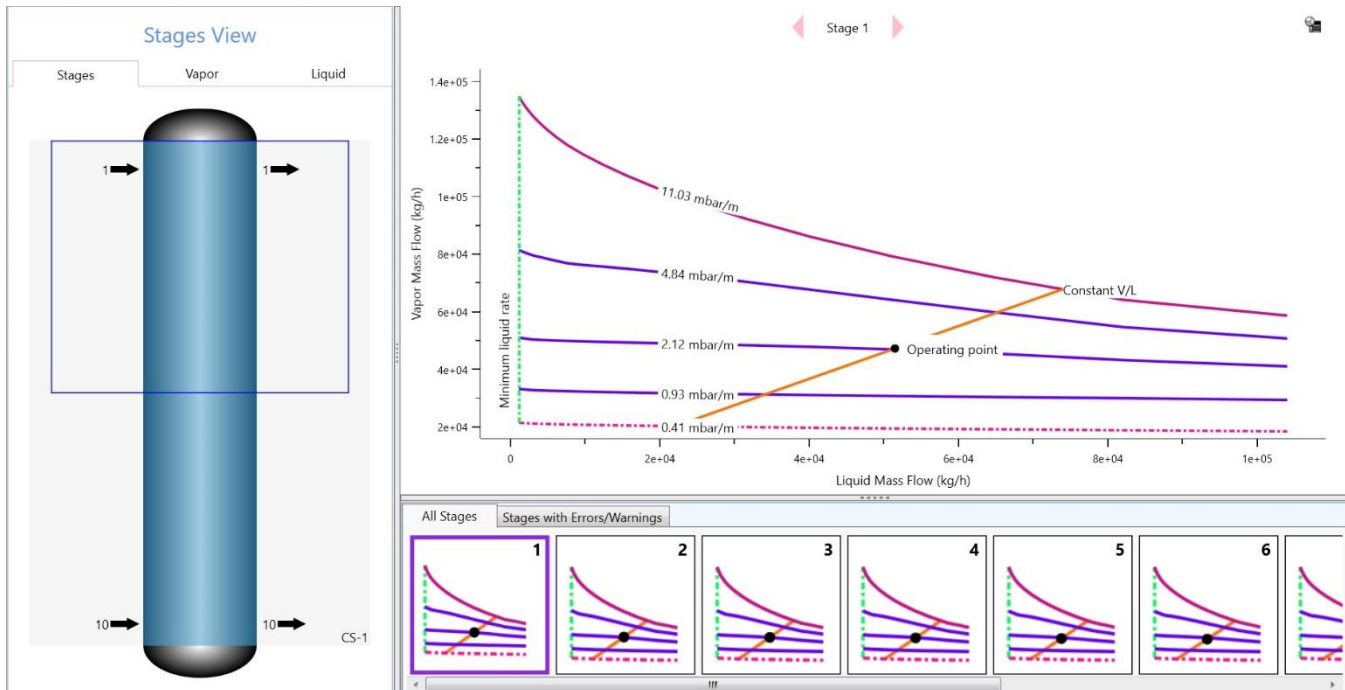

**Figure 4-8** Column hydraulics window for the absorber, with Stage 1 in focus

Additional hydraulic settings can be chosen with the “View” button in the “Details” sub-tab of the “Internals” tab, visible in Figure 4-7. There, a parameter named “Minimum Liquid Flow Rate per Unit Area” was selected to be  $0.200 \text{ m}^3/\text{h}\cdot\text{m}^2$ . This value was entered because AspenTech included that numerical value in its new template of a carbon capture case for a natural gas power plant in HYSYS V12.1. The numerical value was different in templates for acid gas cleaning included with previous versions of HYSYS. The particular template can be found in the novel “Sustainability” template package available only from HYSYS V12.1 upwards. The value of this parameter remains the same for all templates in the “old” Acid gas cleaning template package. This value is a minor detail, but it is important for full replication of simulation and modelling results, as templates are often used for quicker modelling in HYSYS.

In the absorber, 90.03% CO<sub>2</sub> removal efficiency (%mass and %mol) is achieved. The stream “Clean gas” flows out from the top of the absorber with the following composition and physical properties (Table 4-14 and Table 4-15):

**Table 4-14** “Clean gas” composition

Components	Unit	Value	Unit	Value
CO <sub>2</sub>	mol %	0.77	mass %	1.23
O <sub>2</sub>	mol %	12.01	mass %	14.04
N <sub>2</sub>	mol %	74.76	mass %	76.51
H <sub>2</sub> O	mol %	12.45	mass %	8.19
MEA	mol %	0.01	mass %	0.03
Molar flow	kgmole/h	1670.166	-	-
Mass flow	-	-	kg/h	45,718.565

**Table 4-15** “Clean gas” physical properties

Parameter	Unit	Value
Pressure	Pa	105,000
Temperature	°C	54.06
Density	kg/m <sup>3</sup>	1.058
Act. Gas Flow	m <sup>3</sup> /h	43,210.87

The “Rich amine” stream flows out at the bottom of the absorber with the following composition and physical properties (Table 4-16 and Table 4-17):

**Table 4-16** “Rich amine” composition

Components	Unit	Value	Unit	Value
CO <sub>2</sub>	mol %	5.455	mass %	9.833
O <sub>2</sub>	mol %	0	mass %	0
N <sub>2</sub>	mol %	0	mass %	0
H <sub>2</sub> O	mol %	82.971	mass %	61,220
MEA	mol %	11.568	mass %	28.941
Molar flow	kgmole/h	2121.234	-	-
Mass flow	-	-	kg/h	51,791.490

**Table 4-17** “Rich amine” physical properties

Parameter	Unit	Value
Pressure	Pa	115,000
Temperature	°C	47.05
Density	kg/m <sup>3</sup>	1058
Act. Volume Flow	m <sup>3</sup> /h	49.21

The “Rich amine” passes through the “Rich amine pump” which raises its pressure from 115,000 Pa to 300,000 Pa prior to passage through the rich/lean amine heat exchanger and entry into the stripper column. In the heat exchanger, the rich amine attains a higher temperature, which lowers the amount of heat necessary for heat transfer in the desorber, thereby reducing the reboiler energy required for regeneration. The rich amine enters the desorber at the second stage with a temperature of 110°C and a pressure of 300,000 Pa.

The absorber was modelled with 7 stages and a full reflux. The general settings can be seen in Figure 4-9:



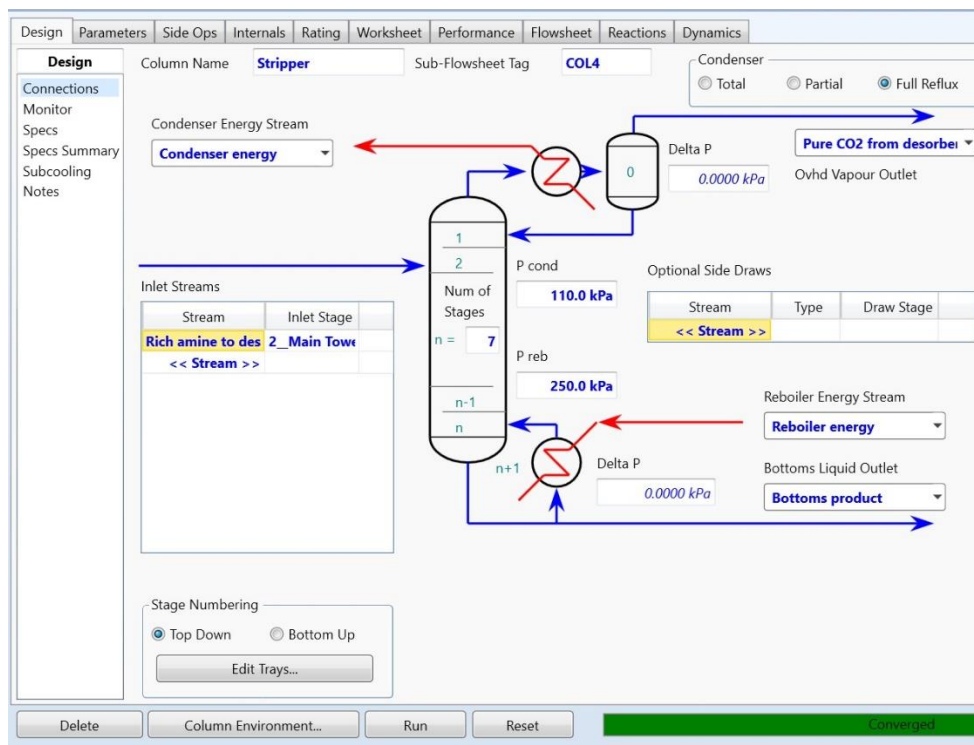

**Figure 4-9** General settings of the desorber

Advanced (Rate-based) modelling was also selected for the stripper. Identical packing settings were chosen as for the absorber. However, the stripper was modelled with two diameters, as shown in Figure 4-10:

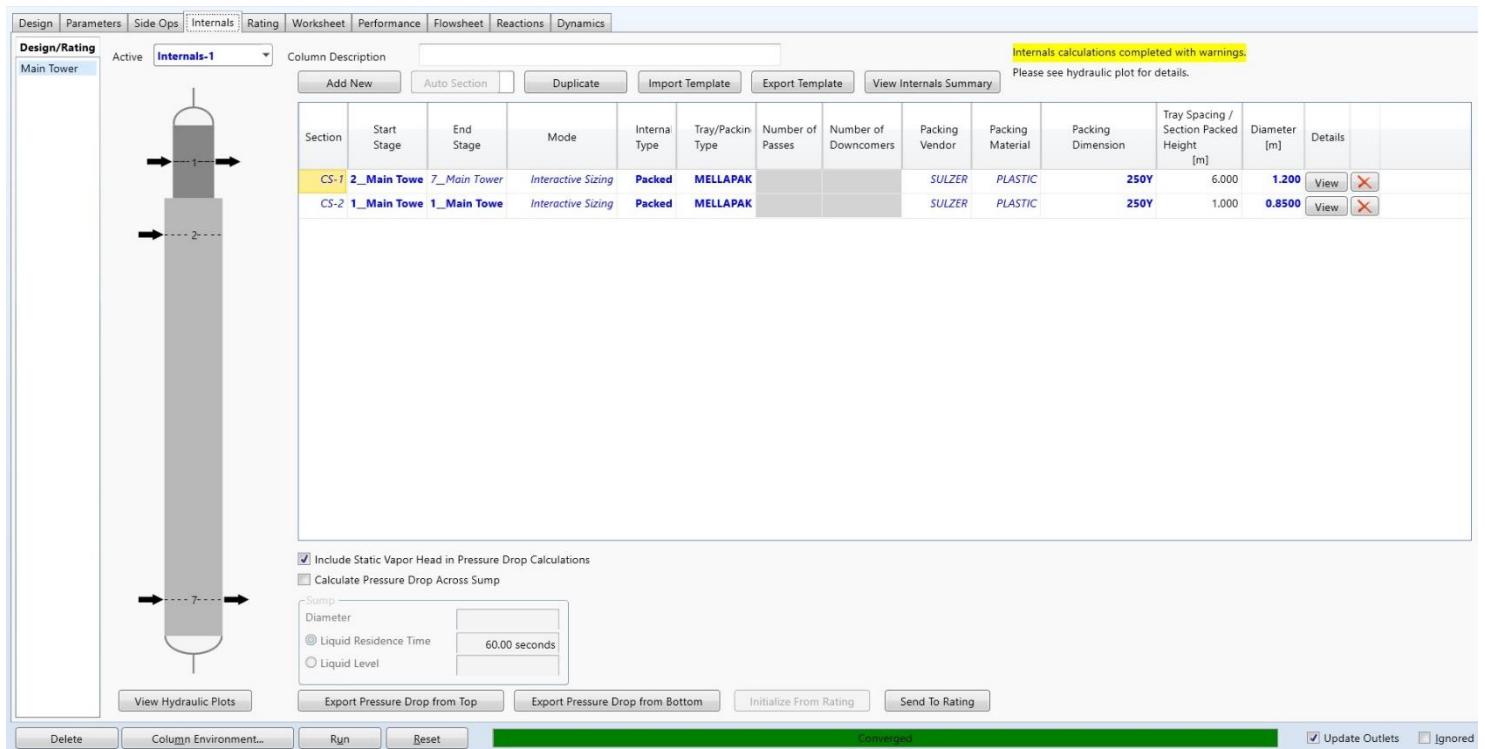

**Figure 4-10** Internals tab of the stripper settings

An error “Internals calculations completed with warnings” is given by HYSYS because a diameter section (stages 2 – 7) was modelled as one section with structured packing longer than 4.572 metres overall. In reality, the packing will indeed be in shorter multiple sections, but that is not important for the purposes of this simulation. Modelling the same diameter section as several separate shorter sections resolves this error. However, the error could also be present in case the operating points on the hydraulic plots approach flooding (excessive vapour flow) or weeping (insufficient vapour flow) points too much.

The hydraulic plots demonstrating a well-performed hydraulic dimensioning for both diameters are shown in Figure 4-11 and Figure 4-12:

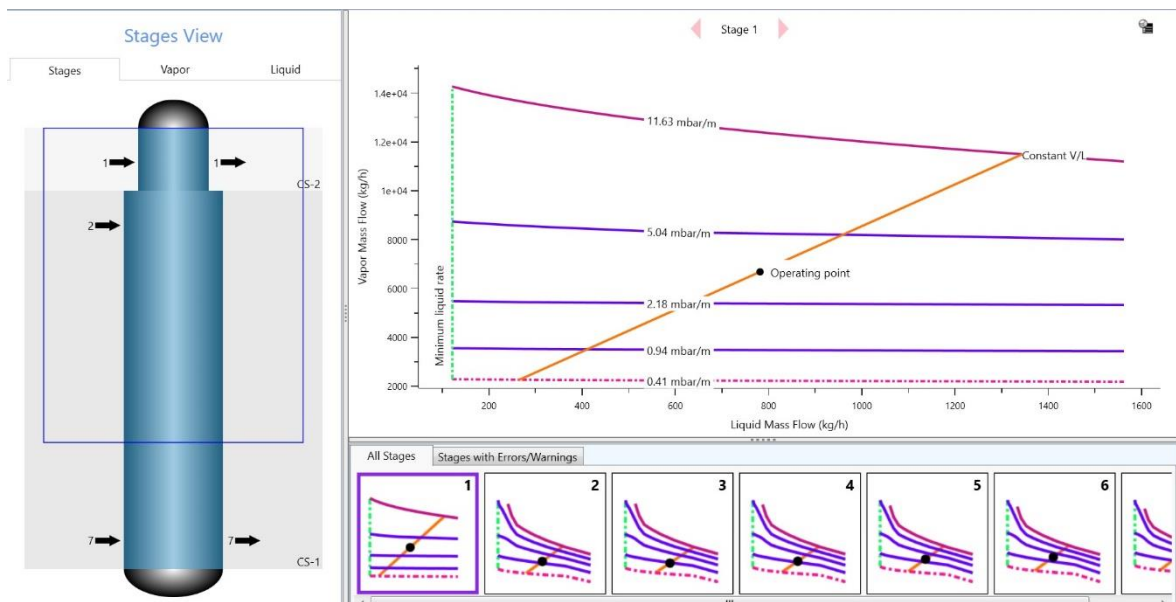

**Figure 4-11** Hydraulic plots of the desorber, Stage 1

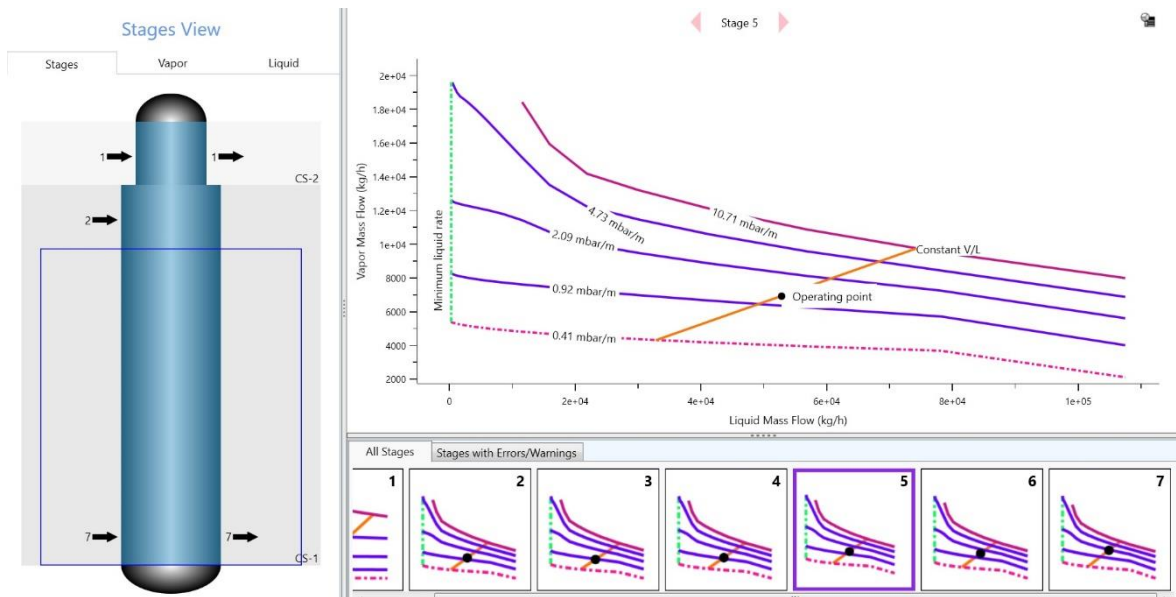

**Figure 4-12** Hydraulic plots of the desorber, Stage 5

Convergence of the stripper column was achieved with parameters of 0.2 reflux ratio and 130°C reboiler temperature. The 130°C temperature is justified for MEA by Jones (2018)

and Google Patents (2006). In case partial reflux is used for the stripper, an additional third parameter must be defined. A mixture predominantly composed of water and CO<sub>2</sub> (with only 0.14% mass of O<sub>2</sub>, N<sub>2</sub>, and MEA) flows out from the top of the stripper into the condenser. Cooling water utility cools the condenser, from which a condensed water mixture flows back into the stripper (this is the reflux), while a vapour mixture with 55.81% mass of CO<sub>2</sub> flows out from the top of the condenser as the “Pure CO<sub>2</sub>” (from desorber) stream. 64.64% (% mass) recovery of CO<sub>2</sub> from the rich amine mixture entering the stripper has been achieved.

The “Pure CO<sub>2</sub>” (from desorber) stream has the following composition and physical properties (Table 4-18 and Table 4-19):

**Table 4-18** “Pure CO<sub>2</sub>” (from desorber) stream composition

Components	Unit	Value	Unit	Value
CO <sub>2</sub>	mol %	34.09	mass %	55.81
O <sub>2</sub>	mol %	0.01	mass %	0.01
N <sub>2</sub>	mol %	0.04	mass %	0.04
H <sub>2</sub> O	mol %	65.86	mass %	44.13
MEA	mol %	0.001	mass %	0.002
Molar flow	kgmole/h	219.413	-	-
Mass flow	-	-	kg/h	5898.524

**Table 4-19** “Pure CO<sub>2</sub>” (from desorber) stream physical properties

Parameter	Unit	Value
Pressure	Pa	110,000
Temperature	°C	90.87
Density	kg/m <sup>3</sup>	0.9840
Act. Volume Flow	m <sup>3</sup> /h	5994.73

The reboiler heat duty has been calculated by HYSYS as  $1.764 \times 10^7$  kJ/h or 4900 kW (4.9 MW). Taking into account that the mass flow of CO<sub>2</sub> in the “Pure CO<sub>2</sub>” stream from the stripper is 3291.979 kg/h, the MEA regeneration energy for CO<sub>2</sub> in this simulation is 5.36 MJ/kgCO<sub>2</sub> captured. This CO<sub>2</sub> mass flow figure is just slightly different than the CO<sub>2</sub> mass flow coming out of the separator, as outlined below, since some CO<sub>2</sub> is inevitably drawn down with the condensing water. The difference between “CO<sub>2</sub> captured” and “CO<sub>2</sub> avoided” metrics is outlined in chapter “5. Economics of the project”.

A regeneration energy between 3 - 4 MJ/kgCO<sub>2</sub> for MEA is often aimed at in literature, as reviewed by Orangi (2021). However, such energies are not necessarily achieved through lowering the absorption efficiency in the absorption column, but rather through lowering the CO<sub>2</sub> mass recovery from the stripper. The reduction in regeneration energy can occur because less CO<sub>2</sub> can be stripped from the rich amine (and the lean amine stream is able to accommodate the extra acid gas loading), with the process still operating normally, which allows for a reduction in reboiler temperature, heat duty, and the regeneration energy, although it also causes a drop in the produced quantity of CO<sub>2</sub> per unit of time. It should be noted that this might be desirable in a pure cost scenario of the process, i.e. carbon capture and storage (CCS). However, if CO<sub>2</sub> is captured for a purpose with a potential positive revenue, spending more heat energy to achieve extra CO<sub>2</sub> recovery might result in a significant revenue increase. A revenue comparison with the first will be outlined in chapter “5. Economics of the project”.

After leaving the condenser, the CO<sub>2</sub> mixture heads into a horizontal separator utilizing water cooling (which could utilize the seawater at the site of the terminal) to ensure greater removal of water. Figure 4-13 shows the settings of the separator in HYSYS.

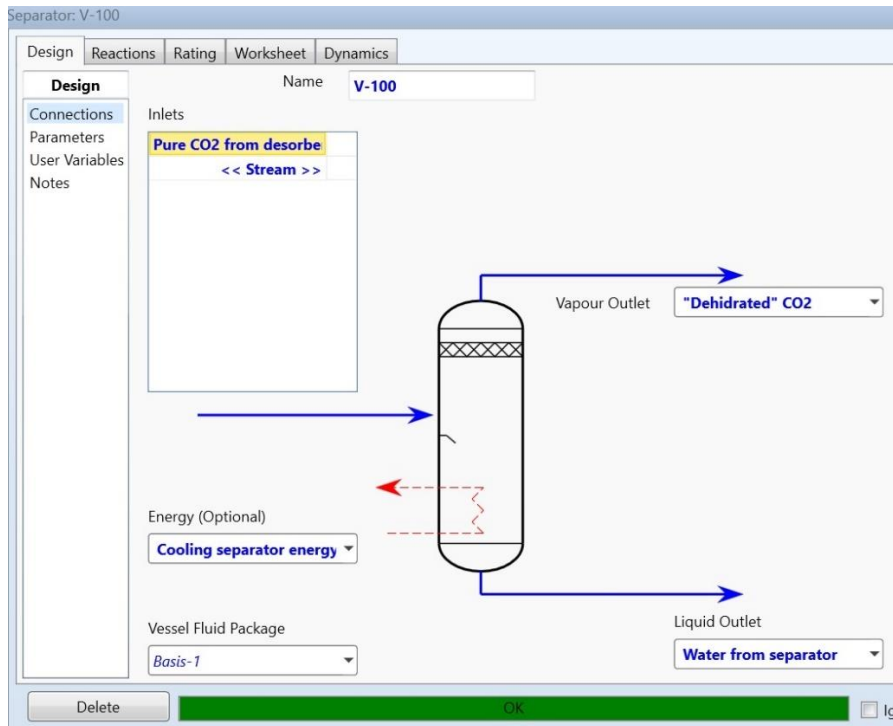

**Figure 4-13** Horizontal separator for water removal (HYSYS settings menu)

In the parameters sub-tab, a heating duty of  $-5.6 \times 10^6$  kJ/h is selected in order to achieve a 90% CO<sub>2</sub> purity (Figure 4-14):

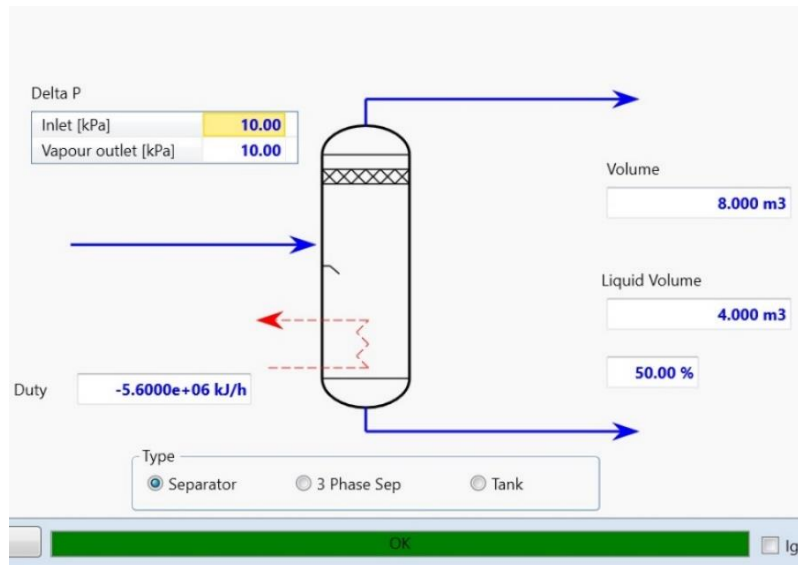

**Figure 4-14** Horizontal separator for water removal, Parameters tab

And a horizontal separator is chosen in the “Rating” tab (Figure 4-15):

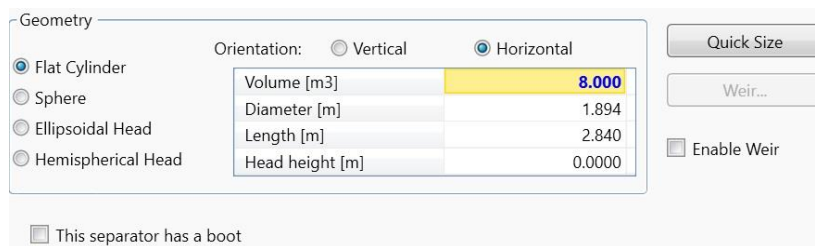

**Figure 4-15** Horizontal separator selection

A cooling water pump for the separator is also simulated in order to obtain the power duty, the power supply cost, and an estimation of the capital cost of the pump (Figure 4-16).

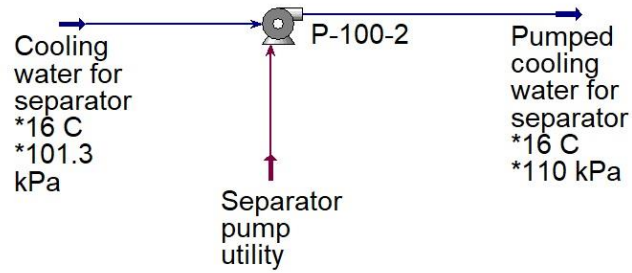

**Figure 4-16** Cooling water pump for the separator

The following are the composition and properties of the “Dehydrated” CO<sub>2</sub> stream (Table 4-20 and Table 4-21):

**Table 4-20** “Dehydrated CO<sub>2</sub>” stream composition

Components	Unit	Value	Unit	Value
CO <sub>2</sub>	mol %	80.081	mass %	90.728
O <sub>2</sub>	mol %	0.028	mass %	0.023
N <sub>2</sub>	mol %	0.092	mass %	0.066
H <sub>2</sub> O	mol %	19.800	mass %	9.182
MEA	mol %	202×10 <sup>-11</sup>	mass %	318×10 <sup>-9</sup>
Molar flow	kgmole/h	93.380	-	-
Mass flow	-	-	kg/h	3627.097

**Table 4-21** “Dehydrated CO<sub>2</sub>” stream physical properties

Parameter	Unit	Value
Pressure	Pa	90,000
Temperature	°C	59.59
Density	kg/m <sup>3</sup>	1.269
Act. Gas Flow	m <sup>3</sup> /h	2857.96



After flowing out of the separator, it is intended for the CO<sub>2</sub> stream to undergo a proper dehydration and liquefaction process in order to reach industrial standard purities, as described above. The mass flow of CO<sub>2</sub> coming out of the separator is 3289.689 kg/hr.

On the other hand, the stream of water flowing out of the separator could be reused for make-up water, for a potential water wash in the absorber to reduce amine loss, or be processed and disposed of in accordance with environmental regulations. According to a Bellona report on health and environmental impacts of amines used in CO<sub>2</sub> capture from 2009, MEA has a relatively high biodegradability and itself has no adverse effect to human health, animals, vegetation, and other organisms (Shao and Stangeland, 2009). However, compounds generated by amine decomposition and corrosion could be problematic for the environment. Additionally, other amines like MDEA and piperazine are ecotoxic and have low biodegradability (Shao and Stangeland, 2009; Chai et al., 2022). Another nearby plant, the Rijeka Refinery owned by INA, d.d., already has an MDEA amine process for purifying fuel gas in order to use it for energy. Wastewater from the entire refinery (including the amine unit) is processed on-site and it is released into the sea in accordance with all environmental regulations and laboratory testing (Budiša et al., 2013). This proves such a procedure is possible in the vicinity of the potential plant. Therefore, experience of the refinery in such operations could be helpful in planning of this project.

The regenerated amine from the stripper flows out from the bottom of the reboiler as the “Bottoms product” stream. The “Bottoms product” stream has the following composition and physical properties (Table 4-22 and Table 4-23):

**Table 4-22** “Bottoms product” stream composition

Components	Unit	Value	Unit	Value
CO <sub>2</sub>	mol %	2.151	mass %	3.924
O <sub>2</sub>	mol %	0	mass %	0
N <sub>2</sub>	mol %	0	mass %	0
H <sub>2</sub> O	mol %	84.946	mass %	63.416
MEA	mol %	12.902	mass %	32.660
Molar flow	kgmole/h	1901.820	-	-
Mass flow	-	-	kg/h	45,892.966

**Table 4-23** “Bottoms product” stream physical properties

Parameter	Unit	Value
Pressure	Pa	250,000
Temperature	°C	130
Density	kg/m <sup>3</sup>	978.917
Act. Volume Flow	m <sup>3</sup> /h	46.88

The Bottoms stream flows into the rich/lean amine heat exchanger to provide heat back to the lean amine flowing into the stripper. The heat exchanger is a shell & tube heat exchanger of TEMA Type AFL with 10,000 Pa specified as the pressure drop for the shell-side fluid. The F shell type enables pure countercurrent flow, which can provide the greatest temperature exchange between the fluids in comparison with other flow types, as outlined in chapter “2.2.2. Process equipment”. The LMTD (logarithmic mean temperature difference) of the heat exchanger is 18.38°C, which is slightly higher than what is usual in literature (Orangi, 2023). A detailed performance of the heat exchanger can be seen in its “Performance” tab (Figure 4-17):

Overall Performance	
Duty	1.131e+007 kJ/h
Heat Leak	0.000e-01 kJ/h
Heat Loss	0.000e-01 kJ/h
UA	6.16e+05 kJ/C-h
Min. Approach	16.847 C
LMTD	18.38 C

Detailed Performance	
UA Curvature Error	0.0000 kJ/C-h
Hot Pinch Temp	63.9403 C
Cold Pinch Temp	47.0933 C
Ft Factor	1.000
Uncorrected LMTD	18.378 C

**Figure 4-17** Information in the Performance tab of the heat exchanger

The plot of temperature and heat flow for the heat exchanger is also available in the “Performance” tab (Figure 4-18):

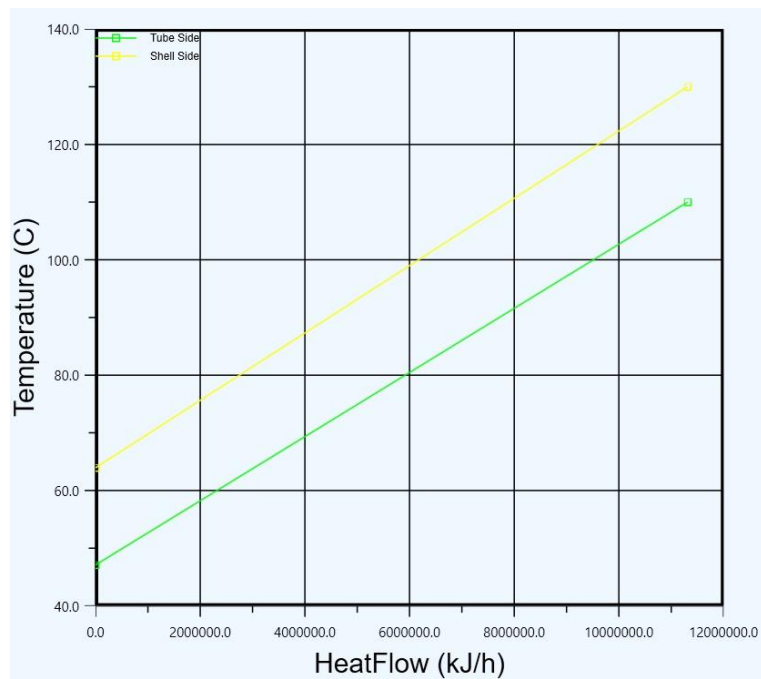

**Figure 4-18** Plot of temperature and heat flow in the Performance tab of the heat exchanger

Once the “Bottoms product” stream flows out of the heat exchanger, it heads towards the mixer in order to regenerate the original 30% amine solution. 12.09 kg/h of MEA (at 15°C and 240,000 Pa) is added to the stream and 4088.90 kg/h (at 15°C and 240,000 Pa) of make-up water is added to the stream. The regenerated amine solution is then passed through a cooler (also a shell & tube heat exchanger) where water (as “Regen cool energy” energy stream) is used to achieve a 30°C solution temperature. There is a pressure drop in the cooler of 130,000 Pa, bringing the solution pressure down to the original 110,000 Pa. From this point, the process with (regenerated) lean amine continues like from the beginning.

Table 4-24 shows all electricity duties in the case:

**Table 4-24** Electricity duties in the first case

Equipment	Energy stream name	Required power
High-temperature fan	Fan energy	329.9 kW
High-temperature fan 2	Fan energy 2	255.3 kW
Water pump 1 (P-100)	Main stream cooler Water utility	1.948 kW
Rich amine pump (P-102)	Rich amine pump energy	3.372 kW
Water pump 2 (P-100-2)	Separator pump utility	0.6151 kW
Make-up water pump (P-100-2-2)	Make-up water stream energy	0.001970 kW
Regenerated amine pump (P-103)	Regen pump energy	2.856 kW

The total electricity duty in the case is 591.135 kW. The MEA make-up pump is not evaluated because of a very small capacity and duty.

Table 4-25 shows all mass flows of cooling water duties in the case:

**Table 4-25** Cooling water duties in the first case

Equipment	Energy stream name	Mass flow
Cooler of main stream	Main stream cooler energy	605,768.54 kg/h
Separator	Cooling separator energy	191,250.30 kg/h
Regenerated amine cooler	Regen cool energy	175,977.53 kg/h

Cooling water is presumed to enter into the heat exchanger at 16°C (the average yearly temperature of sea at the LNG terminal, obtained from LNG Croatia) and exit at 23°C. The temperature of the cooling water can be edited in the “Economics” tab of HYSYS under the Process utilities option, as the default temperatures are different.

Steam mass flow required in the reboiler is 8031 kg/hr. LP Steam utility is used. The lean amine acid gas loading in the case is 0.1667 mol/mol, while the rich amine acid gas loading is 0.4716 mol/mol, which is within the acceptable range in accordance with literature (Apaiyakul et al., 2022b; Orangi, 2021).

#### 4.4. Second case – MEA 30% conc. with 3.83 MJ/kgCO<sub>2</sub>

The second case is also modelled and simulated with 30% MEA. The process flow is the same as for the first case, as shown in Figure 4-5.

The stream “Flue gas from engines” enters the absorber with the same composition and physical properties as in the first case. The “Lean amine” stream enters the absorber with the composition and physical properties as shown in Table 4-26 and Table 4-27, respectively:

**Table 4-26** “Lean amine” stream composition

Components	Unit	Value	Unit	Value
CO <sub>2</sub>	mol %	3.36	mass %	6.17
O <sub>2</sub>	mol %	0	mass %	0
N <sub>2</sub>	mol %	0	mass %	0
H <sub>2</sub> O	mol %	84.87	mass %	63.83
MEA	mol %	11.77	mass %	30.00
Molar flow	kgmole/h	2943	-	-
Mass flow	-	-	kg/h	70,500.00

**Table 4-27** “Lean amine” stream physical properties

Parameter	Unit	Value
Pressure	Pa	110,000
Temperature	°C	30
Density	kg/m <sup>3</sup>	1070.601
Act. Volume Flow	m <sup>3</sup> /h	65.85

The absorber column is set up in the same way as in the first case. It uses structured packing with stage packing height of 1.000 m and the number of stages is 10.

In the “Parameters” tab, “Advanced” (Rate-based) modelling was selected. Packing type has been selected as Mellapak, packing vendor Sulzer, packing material Plastic, and 250Y as packing dimensions. The inner diameter of the column has been chosen as 2.650 m, based on the hydraulic simulation of the column. Diagnostics level was chosen as Medium.

To properly design a column, hydraulic design must also be carried out. Optimized column hydraulics for this case look as shown in Figure 4-19:

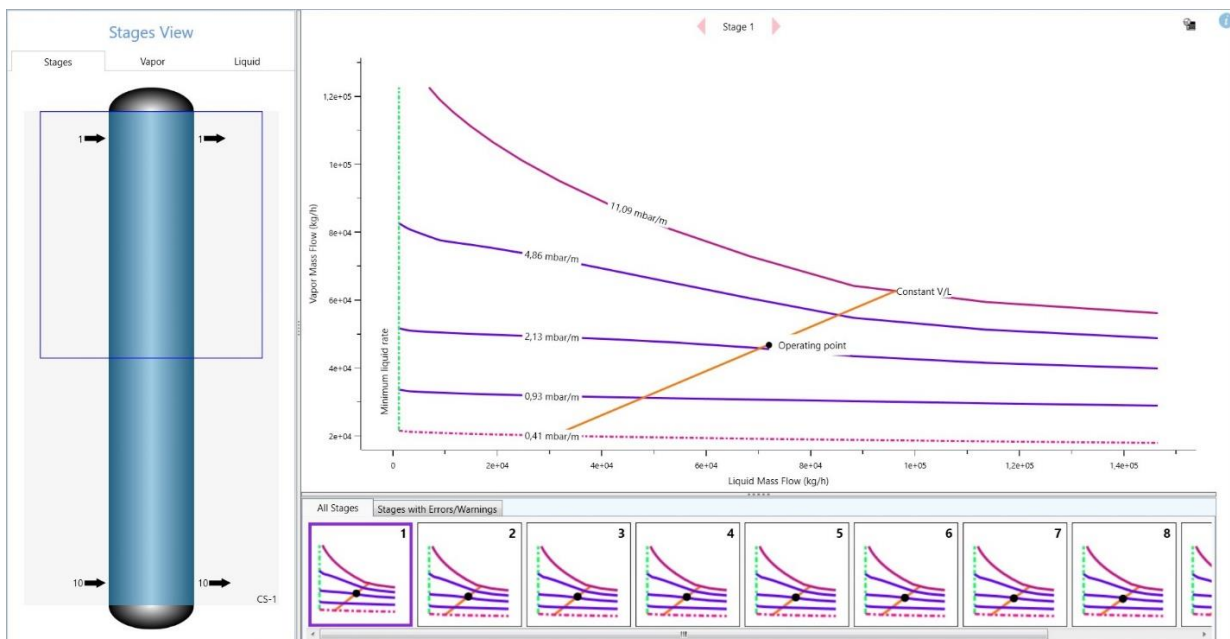

**Figure 4-19** Column hydraulics window for the absorber, with Stage 1 in focus

The parameter named “Minimum Liquid Flow Rate per Unit Area” was also selected to be  $0.200 \text{ m}^3/\text{h}\cdot\text{m}^2$ .

In the absorber, 87.91%  $\text{CO}_2$  removal efficiency (%mass and %mol) is achieved. The stream “Clean gas” flows out from the top of the absorber with the following composition and physical properties (Table 4-28 and Table 4-29):

**Table 4-28** “Clean gas” composition

Components	Unit	Value	Unit	Value
CO <sub>2</sub>	mol %	1.38	mass %	2.19
O <sub>2</sub>	mol %	12.27	mass %	14.16
N <sub>2</sub>	mol %	73.36	mass %	77.16
H <sub>2</sub> O	mol %	12.45	mass %	6.49
MEA	mol %	0.005101	mass %	0.01124
Molar flow	kgmole/h	1635.07	-	-
Mass flow	-	-	kg/h	45,334.42

**Table 4-29** “Clean gas” physical properties

Parameter	Unit	Value
Pressure	Pa	105,000
Temperature	°C	49.56
Density	kg/m <sup>3</sup>	1.088
Act. Gas Flow	m <sup>3</sup> /h	41,665.42

The “Rich amine” stream flows out at the bottom of the absorber with the following composition and physical properties (Table 4-30 and Table 4-31):

**Table 4-30** “Rich amine” composition

Components	Unit	Value	Unit	Value
CO <sub>2</sub>	mol %	5.52	mass %	9.93
O <sub>2</sub>	mol %	0	mass %	0
N <sub>2</sub>	mol %	0	mass %	0
H <sub>2</sub> O	mol %	82.82	mass %	60.97
MEA	mol %	11.66	mass %	29.09
Molar flow	kgmole/h	2969.9	-	-
Mass flow	-	-	kg/h	72,675.64



**Table 4-31** “Rich amine” physical properties

Parameter	Unit	Value
Pressure	Pa	115,000
Temperature	°C	47.50
Density	kg/m <sup>3</sup>	1051.87
Act. Volume Flow	m <sup>3</sup> /h	69.09

The “Rich amine” passes through the “Rich amine pump” which raises its pressure from 115,000 Pa to 300,000 Pa prior to passage through the rich/lean amine heat exchanger and entry into the stripper column. The rich amine enters the desorber at the second stage with a temperature of 110°C and a pressure of 300,000 Pa.

The absorber was modelled with the same general settings as in the first case (7 stages and a full reflux).

Advanced (Rate-based) modelling was also selected for the stripper. Identical packing settings were chosen as for the absorber. However, the stripper was modelled with two diameters. As in the first case, the slimmer diameter extended only to stage 1, while the wider diameter extended from stage 2 to stage 7. The slimmer diameter amounted to 1.03 m, while the wider diameter amounted to 0.65 m.

Hydraulic plots demonstrating the performed hydraulic dimensioning for both diameters are shown in Figure 4-20 and Figure 4-21:

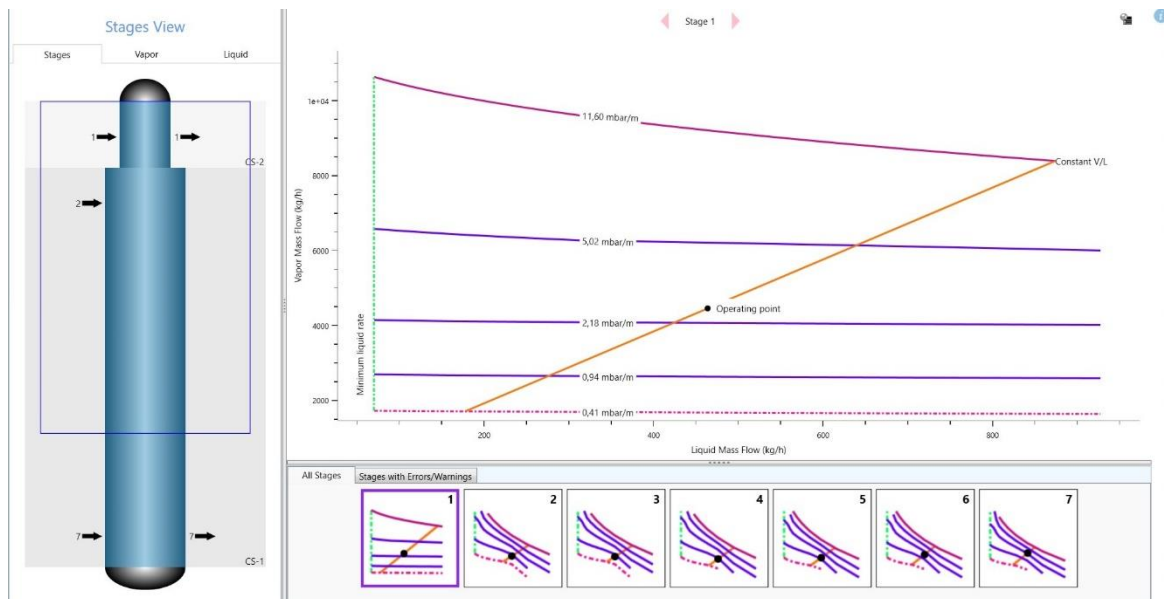

**Figure 4-20** Hydraulic plots of the desorber, Stage 1

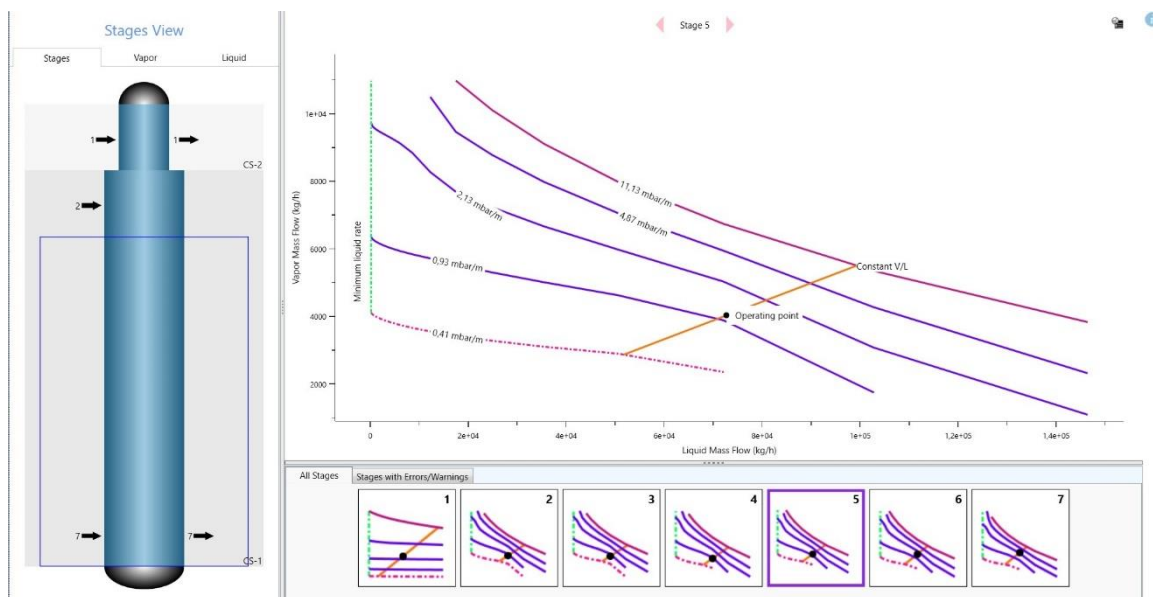

**Figure 4-21** Hydraulic plots of the desorber, Stage 5

Convergence of the stripper column was achieved with parameters of 0.2 reflux ratio and 119°C reboiler temperature. A mixture predominantly composed of water and CO<sub>2</sub> (with

only 0.13% mass of O<sub>2</sub>, N<sub>2</sub>, and MEA) flows out from the top of the stripper into the condenser. Cooling water utility cools the condenser, from which a condensed water mixture flows back into the stripper (this is the reflux), while a vapour mixture with 71.82% mass of CO<sub>2</sub> flows out from the top of the condenser as the “Pure CO<sub>2</sub>” (from desorber) stream. 39.73% (% mass) recovery of CO<sub>2</sub> from the rich amine mixture entering the stripper has been achieved, which is a primary reason for the lower regeneration energy of this case, in comparison with the first case.

The “Pure CO<sub>2</sub>” (from desorber) stream has the following composition and physical properties (Table 4-32 and Table 4-33):

**Table 4-32** “Pure CO<sub>2</sub>” (from desorber) stream composition

Components	Unit	Value	Unit	Value
CO <sub>2</sub>	mol %	51.10	mass %	71.82
O <sub>2</sub>	mol %	0.03	mass %	0.03
N <sub>2</sub>	mol %	0.10	mass %	0.09
H <sub>2</sub> O	mol %	48.77	mass %	28.06
MEA	mol %	4.24×10 <sup>-6</sup>	mass %	8.28×10 <sup>-6</sup>
Molar flow	kgmole/h	127.45	-	-
Mass flow	-	-	kg/h	3990.98

**Table 4-33** “Pure CO<sub>2</sub>” (from desorber) stream physical properties

Parameter	Unit	Value
Pressure	Pa	200,000
Temperature	°C	98.80
Density	kg/m <sup>3</sup>	2.045
Act. Volume Flow	m <sup>3</sup> /h	1951.41

The reboiler heat duty has been calculated by HYSYS as  $1.098 \times 10^7$  kJ/h or 3049 kW (3.05 MW). Taking into account that the mass flow of CO<sub>2</sub> in the “Pure CO<sub>2</sub>” stream from the stripper is 2866.48 kg/h, the MEA regeneration energy for CO<sub>2</sub> in this simulation is 3.83 MJ/kgCO<sub>2</sub> captured. This CO<sub>2</sub> mass flow figure is just slightly different than the CO<sub>2</sub> mass flow coming out of the separator, as outlined below, since some CO<sub>2</sub> is inevitably drawn down with the condensing water.

A regeneration energy between 3 - 4 MJ/kgCO<sub>2</sub> for MEA is often aimed at in literature, as reviewed by Orangi (2021). Hence, as discussed in the first case, it has been proven in this thesis that such energies are not necessarily achieved through lowering the absorption efficiency in the absorption column, but rather through lowering the CO<sub>2</sub> mass recovery from the stripper. This might be desirable in a pure cost scenario of the process, i.e. carbon capture and storage (CCS). However, if CO<sub>2</sub> is captured for a purpose with a potential positive revenue, spending more heat energy to achieve extra CO<sub>2</sub> recovery might result in a significant revenue increase. A revenue comparison with the first will be outlined in chapter “5. Economics of the project”.

After leaving the condenser, the CO<sub>2</sub> mixture heads into a horizontal separator utilizing water cooling (which could be the seawater at the site of the terminal) to ensure greater removal of water, as also outlined in the first case. In the parameters sub-tab, a heating duty of  $-2.5 \times 10^6$  kJ/h is selected in order to achieve a 95.33% (%mass) and 89.43% (%mol) CO<sub>2</sub> purity. A horizontal separator is chosen in the “Rating” tab.

Table 4-34 and Table 4-35 show the composition and properties of the “Dehydrated” CO<sub>2</sub> stream, respectively.

**Table 4-34** “Dehydrated CO<sub>2</sub>” stream composition

Components	Unit	Value	Unit	Value
CO <sub>2</sub>	mol %	89.43	mass %	95.33
O <sub>2</sub>	mol %	0.05	mass %	0.023
N <sub>2</sub>	mol %	0.17	mass %	0.066
H <sub>2</sub> O	mol %	10.35	mass %	4.52
MEA	mol %	$1.65 \times 10^{-12}$	mass %	$2.434 \times 10^{-12}$
Molar flow	kgmole/h	72.80	-	-
Mass flow	-	-	kg/h	3005.61

**Table 4-35** “Dehydrated CO<sub>2</sub>” stream physical properties

Parameter	Unit	Value
Pressure	Pa	180,000
Temperature	°C	59.28
Density	kg/m <sup>3</sup>	2.710
Act. Gas Flow	m <sup>3</sup> /h	1109.05

After flowing out of the separator, it is intended for the CO<sub>2</sub> stream to undergo a proper dehydration and liquefaction process in order to reach industrial standard purities, as described above. The mass flow of CO<sub>2</sub> coming out of the separator is 2865.28 kg/hr.

The regenerated amine from the stripper flows out from the bottom of the reboiler as the “Bottoms product” stream. The “Bottoms product” stream has the following composition and physical properties (Table 4-36 and Table 4-37):

**Table 4-36** “Bottoms product” stream composition

Components	Unit	Value	Unit	Value
CO <sub>2</sub>	mol %	3.48	mass %	6.33
O <sub>2</sub>	mol %	0	mass %	0
N <sub>2</sub>	mol %	0	mass %	0
H <sub>2</sub> O	mol %	84.35	mass %	62.88
MEA	mol %	12.18	mass %	30.79
Molar flow	kgmole/h	2842.44	-	-
Mass flow	-	-	kg/h	68,684.66

**Table 4-37** “Bottoms product” stream physical properties

Parameter	Unit	Value
Pressure	Pa	200,000
Temperature	°C	119
Density	kg/m <sup>3</sup>	1012.83
Act. Volume Flow	m <sup>3</sup> /h	67.81

The Bottoms stream flows into the rich/lean amine heat exchanger to provide heat back to the lean amine flowing into the stripper. The heat exchanger is a shell & tube heat exchanger of TEMA Type AFL with 55,000 Pa specified as the pressure drop for the shell-side fluid. The LMTD (logarithmic mean temperature difference) of the heat exchanger is 7.40°C.

A detailed performance of the heat exchanger can be seen in its “Performance” tab (Figure 4-22):

Overall Performance	
Duty	1,580e+007 kJ/h
Heat Leak	0,000e-01 kJ/h
Heat Loss	0,000e-01 kJ/h
UA	2,14e+06 kJ/C-h
Min. Approach	5,996 C
LMTD	7,397 C

Detailed Performance	
UA Curvature Error	0,0000 kJ/C-h
Hot Pinch Temp	53,5414 C
Cold Pinch Temp	47,5455 C
Ft Factor	1,000
Uncorrected LMTD	7,397 C

**Figure 4-22** Information in the Performance tab of the heat exchanger

The plot of temperature and heat flow for the heat exchanger is also available in the “Performance” tab (Figure 4-23):

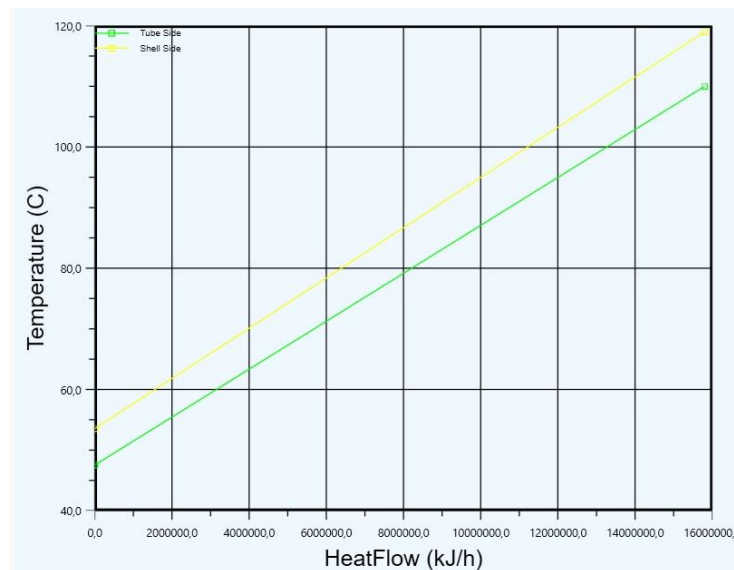

**Figure 4-23** Plot of temperature and heat flow in the Performance tab of the heat exchanger

Once the “Bottoms product” stream flows out of the heat exchanger, it heads towards the mixer in order to regenerate the original 30% amine solution. 5.128 kg/h of MEA (at 15°C

and 101,300 Pa) is added to the stream and 1810.21 kg/h (at 15°C and 101,300 Pa) of make-up water is added to the stream. The regenerated amine solution is then passed through a cooler (also a shell & tube heat exchanger) where water (as “Regen cool energy” energy stream) is used to achieve a 30°C solution temperature. There is a pressure rise in the cooler of 8650 Pa, bringing the solution pressure up to the original 110,000 Pa. From this point, the process with (regenerated) lean amine continues like from the beginning.

Table 4-38 shows all electricity duties in the case:

**Table 4-38** Electricity duties in the second case

Equipment	Energy stream name	Required power
High-temperature fan	Fan energy	329.9 kW
High-temperature fan 2	Fan energy 2	255.3 kW
Water pump 1 (P-100)	Main stream cooler Water utility	4.734 kW
Rich amine pump (P-102)	Rich amine pump energy	3.372 kW
Water pump 2 (P-100-2)	Separator pump utility	0.6151 kW
Make-up water pump (P-100-2-2)	Make-up water stream energy	0.0008723 kW

The total electricity duty in the case is 593.922 kW. The MEA make-up pump is not evaluated because of a very small capacity and duty.



Table 4-39 shows all mass flows of cooling water duties in the case.

**Table 4-39** Cooling water duties in the second case

Equipment	Energy stream name	Mass flow
Cooler of main stream	Main stream cooler energy	605,768.54 kg/h
Separator	Cooling separator energy	85,379.60 kg/h
Regenerated amine cooler	Regen cool energy	184,757.23 kg/h

Cooling water is presumed to enter into the heat exchanger at 16°C (the average yearly temperature of sea at the LNG terminal, obtained from LNG Croatia) and exit at 23°C. Steam mass flow required in the reboiler is 4997 kg/hr. LP Steam utility is used. The lean amine acid gas loading in the case is 0.2856 mol/mol, while the rich amine acid gas loading is 0.4736 mol/mol.

#### 4.5. Third case – MEA 40% conc. with 99% capture efficiency and 99% product purity

A third case is only going to be presented shortly. The third case was made with 40% MEA (%mass) and the goal was to achieve at least 99% capture efficiency in the absorber and at least 99% purity of the CO<sub>2</sub> mixture on exit from the condenser of the desorber (both %mass and %mol). Such criteria should largely increase the price of capture for reasons outlined above in chapter 4. Several optimizations are also done in the case, such as a water wash for the absorber and water from the partial reflux is reused both for the water wash and for the water make-up. The process diagram is shown in Figure 4-24:

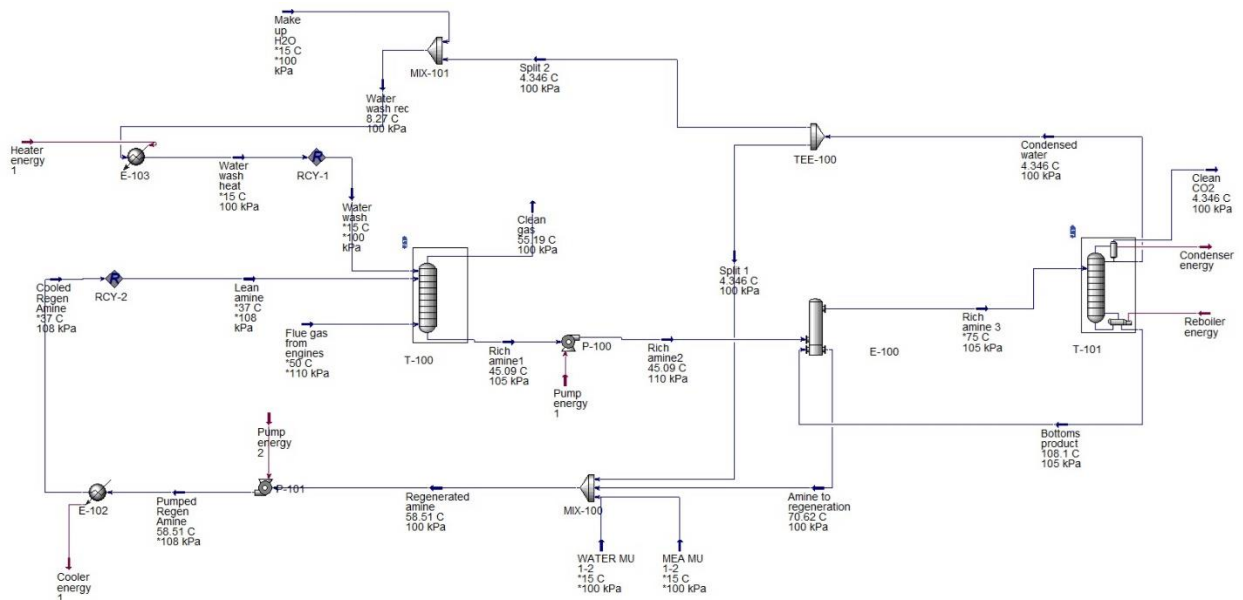
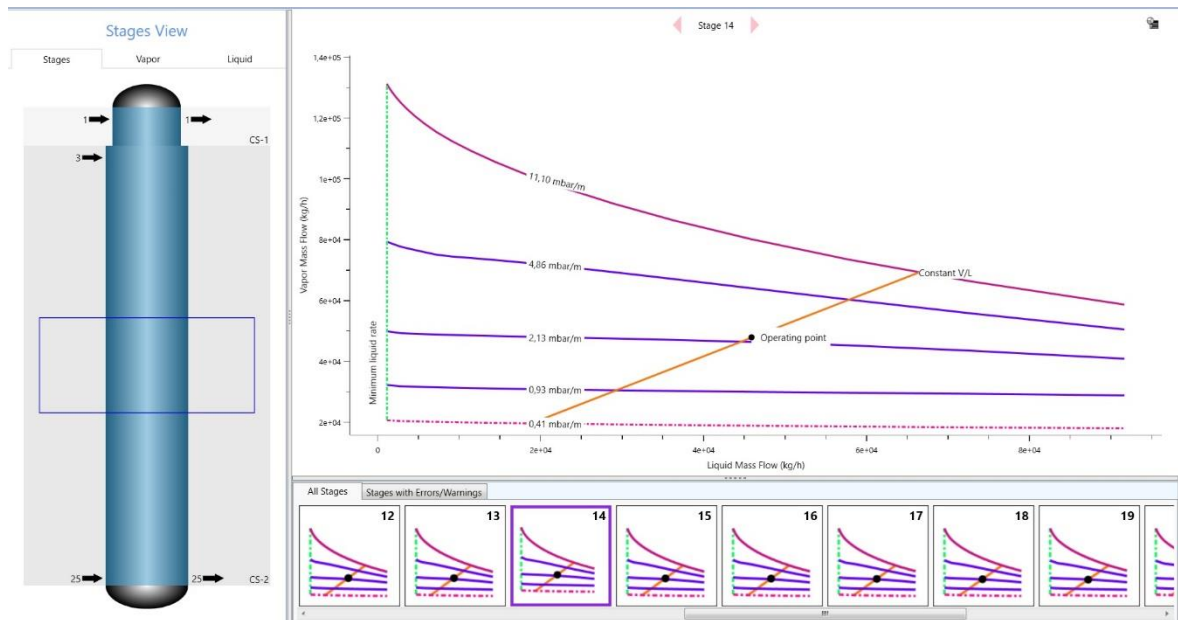

**Figure 4-24** The process diagram of the third case

The pre-treatment is the same as in the previous two cases, except one fan is used and the stream is compressed to 110,000 Pa. A mixture of 40% amine flows into the absorber at stage 3 with a mass flow rate of 40,001.98 kg/hr and a (lean) CO<sub>2</sub> loading of 0.1467 mol/mol. The water wash stream flows into the absorber at the top stage with a flow rate of 4220 kg/hr and a 99.77% (%mass) water content (or 99.91% mol). The purpose of the water wash is to reduce amine losses, as outlined in chapter “2.2.2. Process equipment”. In the “Clean gas”

stream, 21.55 kg/hr of CO<sub>2</sub> and 4.46 kg/hr of MEA flow out of the absorber. The rich amine flows out of the absorber with a mass flow rate of 45,497.64 kg/hr, of which 5535.87 kg/hr is carbon dioxide, and a (rich) CO<sub>2</sub> loading of 0.4798 mol/mol.

The absorber has 25 stages with packing and “Advanced Modeling” is chosen. Stage packing height is 1.00 m. The column has two diameters, 2.2 m for the first two stages and 2.65 m for the rest of the stages. Mellapak packing is used, packing vendor is Sulzer, packing material is Plastic, and 250Y is chosen as packing dimension (for both parts of the column). Hydraulic design was done accordingly and it is shown in Figure 4-25:



**Figure 4-25** Absorber hydraulics window with Stage 14 in focus for the third case

The lean/rich heat exchanger is a TEMA AFL type with LMTD of 29.15°C and detailed performance in Figure 4-26 and 4-27:

Overall Performance	
Duty	4,138e+006 kJ/h
Heat Leak	0,000e-01 kJ/h
Heat Loss	0,000e-01 kJ/h
UA	1,42e+05 kJ/C-h
Min. Approach	25,528 C
LMTD	29,15 C

Detailed Performance	
UA Curvature Error	0,0000 kJ/C-h
Hot Pinch Temp	70,6206 C
Cold Pinch Temp	45,0922 C
Ft Factor	1,000
Uncorrected LMTD	29,147 C

**Figure 4-26** Information in the Performance tab of the heat exchanger



**Figure 4-27** Plot of temperature and heat flow in the Performance tab of the heat exchanger

The heated rich amine stream enters into the stripper at stage 4. The desorber also has 25 stages with packing and “Advanced Modeling” is chosen. Stage packing height is also 1.00

m. The column has two diameters, 1.25 m for stages 1 - 3 and 1.85 m for the rest of the stages. Mellapak packing is used, packing vendor is Sulzer, packing material is Plastic, and 250Y is chosen as packing dimension (for both parts of the column). Hydraulic design was done accordingly and it is shown in Figure 4-28:

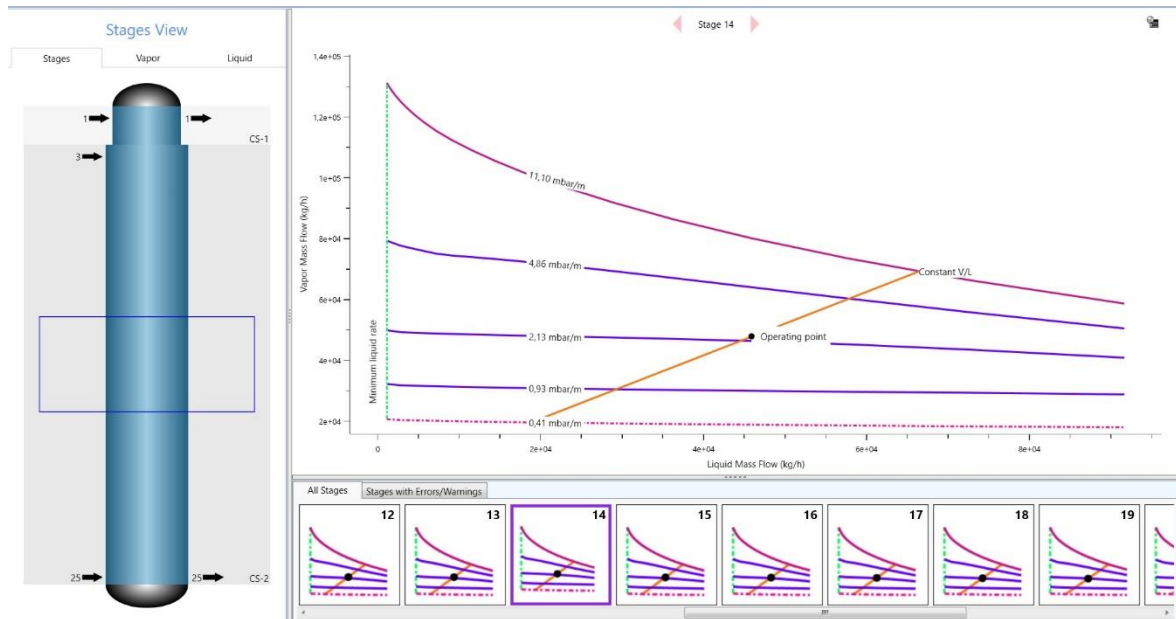

**Figure 4-28** Stripper hydraulics window with Stage 14 in focus for the third case

The desorber column was successfully converged with parameters of 88.00 kgmole/hr vapour flow from condenser, 500 kgmole/hr condensate flow from the condenser, and 3.500e+7 kJ/hr reboiler duty, as shown in Figure 4-29:

Specifications						
	Specified Value	Current Value	Wt. Error	Active	Estimate	Current
Vapour flow from cond.	<b>88,00 kgmole/h</b>	88,00	-0,0000	<input checked="" type="checkbox"/>	<input checked="" type="checkbox"/>	<input checked="" type="checkbox"/>
Condensate flow from cor	<b>500,0 kgmole/h</b>	500,1	0,0002	<input checked="" type="checkbox"/>	<input checked="" type="checkbox"/>	<input checked="" type="checkbox"/>
Reboiler Duty	<b>3,500e+007 kJ/h</b>	3,500e+007	-0,0000	<input checked="" type="checkbox"/>	<input checked="" type="checkbox"/>	<input checked="" type="checkbox"/>
CO2 recovery fraction	<empty>	0,6928	<empty>	<input type="checkbox"/>	<input checked="" type="checkbox"/>	<input type="checkbox"/>
Reflux Ratio	<b>1,200</b>	0,9122	-0,2398	<input type="checkbox"/>	<input checked="" type="checkbox"/>	<input type="checkbox"/>
Reflux Rate	<empty>	536,5	<empty>	<input type="checkbox"/>	<input checked="" type="checkbox"/>	<input type="checkbox"/>
CO2 product fraction	<b>0,9900</b>	0,9902	0,0002	<input type="checkbox"/>	<input checked="" type="checkbox"/>	<input type="checkbox"/>
Condenser temperature	<empty>	4,346	<empty>	<input type="checkbox"/>	<input checked="" type="checkbox"/>	<input type="checkbox"/>
Bottoms product Rate	<empty>	1129	<empty>	<input type="checkbox"/>	<input checked="" type="checkbox"/>	<input type="checkbox"/>
Reboiler temperature	<empty>	108,1	<empty>	<input type="checkbox"/>	<input checked="" type="checkbox"/>	<input type="checkbox"/>

**Figure 4-29** Stripper specifications

As mentioned previously, an additional, third, parameter must be defined in case partial reflux is used for the stripper, so that the “Degrees of Freedom” equal 0 and HYSYS can try to converge the column. 64.28% (%mass and %mol) recovery of CO<sub>2</sub> from the rich amine mixture entering the stripper has been achieved. 3835.07 kg/hr of CO<sub>2</sub> flow out of the condenser of the stripper with the “Clean CO<sub>2</sub>” stream. The purity of the CO<sub>2</sub> in the produced mixture is 99.57% (%mass) and 99.02% (%mol), so the goal of the case has been achieved.

The amine stream of the bottoms product goes to regeneration by three streams: 8.36 kg/hr of MEA and two make-up water streams. The standalone water make-up stream contributes 1010.56 kg/hr. The condensed water stream, from the condenser of the stripper, contributes the other part. The “Condensed water” stream has a flow rate of 9028.79 kg/hr and it is made up of 99.65% water (%mass), or 99.86% (%mol) of water, with a small amount of CO<sub>2</sub> (26.37 kg/hr) and MEA (5.57 kg/hr) contributing the rest. The condensed water stream is split into two parts to provide water for the water wash in the absorber and for the amine solution make-up process. The stream contributes to make-up water with a flow rate of 6353.79 kg/hr (6331.31 kg/hr of water).

The “Condensed water” stream also splits into another stream with the flow rate of 2675.00 kg/hr for the water wash. The flow ratios for the two streams in TEE-100 are approximately 0.704 and 0.296. The %mol and %mass compositions of the two streams are identical. Another stream of 1545.00 kg/hr of water is added to complete the water wash stream, which is then heated before entering the absorber at the top stage.

The regenerated amine stream is pumped and cooled before entering the absorber at the third stage. Steam mass flow required in the reboiler is 15,935.17 kg/hr. LP Steam utility is used. The reboiler heat duty has been set as 3.5e+7 kJ/h or 9722 kW (9.72 MW). Taking into account that the mass flow of CO<sub>2</sub> in the “Clean CO<sub>2</sub>” stream from the stripper is 3835.06 kg/h, the MEA regeneration energy for CO<sub>2</sub> in this simulation is 9.13 MJ/kgCO<sub>2</sub>. The total electricity duty in the case is 212.772 kW. All mass flows of cooling water duties in the case are 657,670.01 kg/hr.

## 5. ECONOMICS OF THE PROJECT

In this chapter, the foundational assumptions for the economic analysis are going to be provided and the scenarios presented in chapter “4. Modelling post-combustion capture of CO<sub>2</sub> with Aspen HYSYS” are going to be evaluated.

### 5.1. Foundational assumptions for the economic analysis

#### 5.1.1. Capital expenditures (CAPEX) and operating expenditures (OPEX)

The total costs of the project are divided into capital expenditures (CAPEX) and operating expenditures (OPEX). CAPEX are the “*funds used by a company to acquire, upgrade, and maintain physical assets such as property, plants, buildings, technology, or equipment*” (Investopedia, 2024a). Capital expenditures include purchases like buildings, land, ground preparations, engineering costs, equipment, utility connections to infrastructure, computers and servers, vehicles, furniture, and patents (Investopedia, 2024a; Kallevik, 2010; Orangi, 2021). OPEX are shorter-term expenses required for day-to-day costs of running a business and occur on a “*regular and predictable basis*”, such as wages and utility costs (Investopedia, 2024a). CAPEX in this thesis is going to include equipment costs and it is going to be based on the cost of equipment provided by the Aspen Process Economic Analyzer (APEA), an economic evaluation tool integrated into HYSYS. Because of an update of the HYSYS university licence during the drafting of the thesis, the economic evaluation has been conducted in HYSYS V14. Therefore, provided costs of this version of APEA refers to the year 2022. APEA provides the costs based on operating conditions and required materials. Of course, the actual, and most accurate, costs of equipment are going to be provided in a quotation offered by an equipment vendor.

Since the costs provided by APEA are for 2022, inflation must be taken into account to update the CAPEX for each case. In chemical engineering projects, the change in cost due to inflation can be evaluated by using the Chemical Engineering Plant Cost Index (CEPCI) (chemengonline.com, n.d.; Vatavuk, 2002; Orangi, 2021). The equation used for adjusting the CAPEX value with the help of CEPCI is:

$$CAPEX_{2024} = CAPEX_{2022} \times \frac{CEPCI_{2024}}{CEPCI_{2022}} \quad (5-1)$$

where  $CEPCI_{2024}$  is the average value of CEPCI for 2024,  $CEPCI_{2022}$  is the average value of CEPCI for 2022,  $CAPEX_{2024}$  is the updated amount of CAPEX for 2024 and  $CAPEX_{2022}$  is the amount of CAPEX obtained by APEA in HYSYS. Values of CEPCI are published monthly and lag three months (Maxwell, 2024), so there is a yearly average value available for 2022. However, an average of values up to, and including, April 2024 is going to be used for  $CEPCI_{2024}$ . The average value of CEPCI for 2022 is 816.0. The values used for 2024 are going to be for January (795.4), February (800.0), March (800.7), and April (799.1, a preliminary figure) (Maxwell, 2024). Therefore, the value of CEPCI for 2024 is currently 798.8.

Aspen HYSYS does not include the ability to estimate the cost of certain equipment, e.g. mixers, so a manual cost estimation procedure should be carried out for such equipment. Also, Aspen HYSYS does not include high-temperature industrial fans in its process equipment, so a manual cost estimation procedure should be carried out for these.

Since only major equipment is evaluated in this thesis, other items like control valves, mixers, piping, etc. are not evaluated. Therefore, the CAPEX for each case is going to be increased by 20% to better account for the cost of other equipment and capital costs, as recommended by Orangi (2021). The costs of design, engineering, procurement, and construction are also not covered in this thesis. Likewise, crew wages are not covered in OPEX by this analysis.

Net present value (NPV) calculation is going to be carried out in Microsoft Excel using the Equation 5-2 (Investopedia, 2024b):



$$NPV = \sum_{t=0}^n \frac{R_t}{(1+i)^t} \quad (5-2)$$

where NPV is the net present value of the project,  $R_t$  is the cash flow in year  $t$ ,  $i$  is the discount rate, and  $t$  is the number of the time period.

#### 5.1.2. The discount rate

The discount rate used in the economic analysis is going to be 7%, which is the value used by LNG Croatia (LNG Hrvatska, 2023b).

#### 5.1.3. Maintenance costs

Maintenance cost are yearly costs required to repair and upkeep owned assets (Orangi, 2021). The value of maintenance costs is usually expressed as a percentage of the CAPEX. A value of 4% of CAPEX, based on analysis by Orangi (2021) is going to be used in each case. Maintenance costs are a part of OPEX.

#### 5.1.4. Time of plant operation

The plant operation lifetime is taken as 25 years. The projected operation lifetime of the FSRU is 20 years, although this can be prolonged, while the projected operation lifetime of the mainland part of the terminal is 40 years (LNG Hrvatska, 2023b). Therefore, the plant could operate for even longer, but 25 years was selected as a safe timeframe before a complete overhaul would be required.

The number of working hours of the plant in a year is taken as 8598 hours. The LNG terminal has a 7-day general maintenance period each year, so the terminal operates for 358 days each regular year, or 8592 hours. However, there are 6 leap years in 25 years (if the 1st year of operation is a regular year and the 4th year of operation is the first leap year in the 25-year period), where the number of days is 366 and the number of working hours of the LNG terminal is, therefore, 8616. There are 19 non-leap years in such a case. Therefore, the

number of working hours in 25 years has been calculated as a weighted average of working hours in 19 non-leap years and of working hours in 6 leap years, as follows:

$$\frac{8592 \frac{hr}{year} \times 19 \text{ year} + 8616 \frac{hr}{year} \times 6 \text{ year}}{25 \text{ year}} = 8597.76 \frac{hr}{year} \quad (5-3)$$

The weighted average calculates to 8597.76 hours/year, which is rounded to 8598 hours/year. In reality, it cannot be guaranteed that the plant will commence operations on the first year after a leap year, so the actual number of average yearly working hours might be somewhat different.

#### 5.1.5. The price of electricity

The price of electricity was obtained from HEP OPSKRBA d.o.o. for their tariff model HEP PRO, which is aimed at large customers (e.g. shipyards, hospitals, ironworks, glass industry, aluminum industry, industrial plants, office buildings, etc.) and includes a higher (day) and a lower (night) tariff. The price of electricity in the HEP PRO model is currently 0.249187 EUR/kWh for the day tariff and 0.159225 EUR/kWh for the night tariff (HEP OPSKRBA, 2023b). The day tariff is applied from 07:00 to 21:00 hours during the winter time and from 08:00 to 22:00 during the Daylight Savings Time, while the night tariff is applied from 21:00 to 07:00 hours during the winter time and from 22:00 to 08:00 hours during the Daylight Savings time (HEP OPSKRBA, 2023a). In either case, the day tariff is applied during 14 hours of the day and the night tariff is applied during 10 hours of the day. Since the carbon capture plant is presumed to work 24 hours a day in a steady-state condition, an effective electricity price shall be used to simplify the calculation.

The effective electricity price for the period of 1 day (24 hours) is obtained by calculating a weighted arithmetic mean of the tariff prices:

$$\frac{14 h \times 0.249187 \frac{EUR}{kWh} + 10 h \times 0.159225 \frac{EUR}{kWh}}{24 h} = 0.2192 \frac{EUR}{kWh} \quad (5-4)$$

Therefore, 0.2192 EUR/kWh has been calculated as the effective electricity price for the plant.

#### 5.1.6. The price of MEA

The price of MEA has been sourced from Aromada et al. (2021), where it is declared as 2069 EUR/m<sup>3</sup>, which is 2.069 EUR/litre. The price can be recalculated for 2024 by using an online inflation calculator for the eurozone at officialdata.org (2024). Therefore, the price of MEA has been calculated as 2.49 EUR/litre for 2024 and, finally, 2.45 EUR/kg by using the MEA density value of 1016 kg/m<sup>3</sup> from Alliance Chemicals (2021). It should be noted that this calculation does not include changes in the real cost, but only in the nominal cost, so the real price is likely different. Some online MEA price indices claim an even lower price of MEA in Europe, such as Intratec Solutions (2024) and Business Analytiq (2024).

A few prices of MEA have been provided in literature for the US market as well. A price of 0.87 USD/lb was declared in Sexton et al. (2016). This would be 1.14 USD/lb in 2024 US dollars per usinflationcalculator.com (2024) and then 2.26 EUR/kg with the exchange rate of 1 USD = 0.89846689 EUR on 29<sup>th</sup> August 2024 from XE.com (2024). A conversion factor of 1 pound (lb) = 0.45359237 kilograms (kg) from RapidTables.com (2024) was also used. A technical report by Fisher et al. (2005) provides 1200 USD/tonne as the price of MEA, which converts into 1.74 EUR/kg in 2024.

As far as other amines are concerned, a price of 19.50 HRK/kg for MDEA in 2022 in Croatia was obtained from Hemetek Potroško (2023).

### 5.1.7. The price of process water

The price of process water (used for the MEA solution and the Make-up Water stream) is taken as 0.0002665064 EUR/kg. This is a price assumed for the purchase of process water directly from a vendor. The price has been deduced from several sources. Fisher et al. (2005) and Fisher et al. (2007) estimated the price of water at 0.92 USD/1000 gallons, which is 0.8265895388 EUR/1000 gallons. As 1 US gallon is 3.785411784 litres (unitconverters.net, 2024), the price of 0.0002184 EUR/litre can be obtained. Since HYSYS provides the density of make-up water at 15°C as 999.2 kg/m<sup>3</sup>, the price of 0.0002186 EUR/kg can be obtained. Adjusting for the 51.7% cumulative inflation rate for USD from 2007 until 2024 (usinflationcalculator.com, 2024) results in 0.0003316 EUR/kg.

Another estimate was given by Panja et al. (2022) as 1,465,000 USD/year for 3600 gpm (gallons per minute) for “Raw make-up water”. This would be 1,855,872,000 gallons per year (based on 8592 working hours per year), 13,627.482 litres per minute or 7,025,239,738.396 litres per year for a case with 90% capture of CO<sub>2</sub> from the flue gas of a power plant. In total, the price of make-up water amounts to 0.0002085338 USD/litre or 0.0001873607 EUR/litre. With the water density of 999.2 kg/m<sup>3</sup>, this results in 0.0001875107 EUR/kg. Adjusting for the 7.5% cumulative inflation rate for USD from 2022 until 2024 (usinflationcalculator.com, 2024) results in 0.0002014128 EUR/kg.

The arithmetic average of the two values (0.0003316 EUR/kg and 0.0002014128 EUR/kg) results in 0.0002665064 EUR/kg, which is going to be used in this thesis.

However, it is also possible to produce own water at the plant. A municipal water connection is available at the terminal and LNG terminals are usually located at a seashore, where seawater is also an available resource. Of course, demineralization and desalination would be required for such water sources. Desalination is the removal of minerals from water such that the water can become potable or non-potable water or used for irrigation (Devčić, 2022). Demineralization is the removal of all, or almost all, dissolved minerals from water such that the water can be used for chemical processes and steam boilers (Baranović, 2020).

Demineralization can be used to provide high-purity water for industrial, and chemical, processes and it is possible to apply demineralization to water sourced from a public utility (Crnobrnja, 2008; Čaušević Pokas, 2018; Baranović, 2020; Pahljina, 2023; Cigula, 2018). Desalination and demineralization would be required for sea water, which is overall more expensive to treat than freshwater (Pahljina, 2023; Džeko, 2009; Cigula, 2018). Evaluation of the price of demineralization and the price of desalination is beyond the scope of this thesis, although rough estimates are provided by Pahljina (2023) as 9.5 EUR/1000 litres, then from 0.5 USD/m<sup>3</sup> to 2.5 USD/m<sup>3</sup>, and up to 3.20 USD/m<sup>3</sup> for different types of plants. Estimates are also provided by Džeko (2009) as 9.2772 HRK/m<sup>3</sup> for seawater and 12.66 HRK/m<sup>3</sup> for brackish water. It should be noted that such water treatment plants entail a larger plant area overall, although the possible extent of the plant area is not considered in this thesis.

It is less likely that well water or surface freshwater would be available as a resource, as the land part of the terminal is located on a karst island with no surface freshwater bodies in the near vicinity, at least not of considerable size. Such sources are sometimes possible for other mainland plants, such as the demineralized well water used at CPS Molve in the process of treating produced natural gas (Hemetek Potroško, 2023).

#### 5.1.8. The price of steam

The price of steam for the plant is taken as 24.77 EUR/tonne. A price of 30 EUR/tonne for MP Steam at Rijeka Refinery was obtained from Dejanović (2023), while a price of 17 EUR/tonne for steam was obtained from Ali et al. (2019), and a price of 0.032 EUR/kWh for steam was obtained from Aromada et al. (2021). With the price of 0.032 EUR/kWh, a price of 19.52 EUR/tonne was calculated based on the first 30% MEA case:

$$\frac{4900 \text{ kW} \times 8598 \frac{\text{hr}}{\text{year}} \times 0.032 \frac{\text{EUR}}{\text{kWh}}}{8.031 \frac{\text{tonne}}{\text{hr}} \times 8598 \frac{\text{hr}}{\text{year}}} = 19.52 \frac{\text{EUR}}{\text{tonne}} \quad (5-5)$$

The three prices were then adjusted for eurozone inflation with the calculator from officialdata.org (2024) and 30.23 EUR/tonne, 20.60 EUR/tonne, and 23.48 EUR/tonne were obtained, respectively. An arithmetic average of 30.23 EUR/tonne, 20.60 EUR/tonne, and 23.48 EUR/tonne was considered as a reasonable estimation, since it takes into account values from literature and a similar plant in the proximity of the LNG terminal. The plant uses LP steam in the simulation, which is less expensive than MP and HP steam. It is unclear whether the price of steam in literature includes the price of water or not, but the cost of traditional energy (e.g. natural gas) contributes significantly more to the price of steam. Therefore, the cost of water for the production of steam is not evaluated in this thesis.

Furthermore, since the LNG terminal uses the LNG boil-off gas for free for electricity generation, it is possible that such natural gas could also be used for steam generation. In this case, the cost of steam generation (and, therefore, the regeneration energy) would be virtually free for the LNG terminal. Therefore, the price of carbon capture is going to be expressed with and without the cost of steam for each case in the economic analysis. Of course, if the terminal could not cover the entire consumption from the boil-off gas, it could possibly cover at least a part of it. The required yearly amount of natural gas to enable the heat transfer in the reboiler can be calculated for each case from the heat flow in the reboiler provided by HYSYS, the higher heating value (HHV) for natural gas, and the yearly amount of operating hours of the plant. HYSYS provides the heat flow value in kJ/hr, while HHV is usually provided in kWh/m<sup>3</sup> (Gradska plinara Zagreb - Opskrba [GPZ - Opskrba], 2024) or in MJ/m<sup>3</sup>. If HHV is expressed in MJ/m<sup>3</sup>, the required amount of natural gas can be calculated with the following equation:

$$\frac{\frac{\text{Heat flow} \frac{\text{kJ}}{\text{hr}}}{1000 \frac{\text{kJ}}{\text{MJ}}} \times 8598 \frac{\text{hr}}{\text{year}}}{\text{HHV} \frac{\text{MJ}}{\text{m}^3}} = \text{RNG} \frac{\text{m}^3}{\text{year}} \quad (5-6)$$

where heat flow is the amount of heat being transferred from the steam to the stripped amine mixture in the reboiler in kJ/hr, 1000 kJ/MJ is the factor used to transform the heating value from kJ to MJ, HHV is the higher heating value of natural gas in MJ/m<sup>3</sup>, and RNG is the volume of required natural gas per year. The HHV can be provided as a range by natural gas suppliers. For example, Gradska plinara Zagreb - Opskrba d.o.o. (GPZ) provides the HHV as a range from 10.28 kWh/m<sup>3</sup> to 12.75 kWh/m<sup>3</sup> (GPZ - Opskrba, 2024). Therefore, the arithmetic mean of the lower and higher value (11.515 kWh/m<sup>3</sup>) is going to be used for such calculations in this thesis.

If the HHV is expressed in kWh/m<sup>3</sup>, the heat flow can be transformed from kJ into kWh for an easier calculation:

$$\frac{\frac{\text{Heat flow} \frac{\text{kJ}}{\text{hr}}}{3600 \frac{\text{kJ}}{\text{kWh}}} \times 8598 \frac{\text{hr}}{\text{year}}}{\text{HHV} \frac{\text{kWh}}{\text{m}^3}} = \text{RNG} \frac{\text{m}^3}{\text{year}} \quad (5-7)$$

If 0.9 is assumed as heat transfer efficiency (e.g. in a direct fired heater) between natural gas and the water or steam, then the obtained RNG value should also be divided by 0.9.

In any case, if a fossil fuel, such as natural gas, is used for steam production, there are also associated CO<sub>2</sub> emissions as a by-product of the process. Natural gas is assumed as the fuel for steam generation at the plant in the simulation. To calculate the amount of CO<sub>2</sub> emissions, a CO<sub>2</sub> emissions factor of natural gas can be used. The CO<sub>2</sub> emissions factor obtained is 56.1 tonnes CO<sub>2</sub>/TJ (MINGOR, 2023; LNG Hrvatska, 2022a).

Usually, electricity and steam for industrial plants are generated in an on-site Combined Heat and Power (CHP) plant and extra electricity can be sold to a power utility company (Dejanović, 2023; Hemetek Potroško, 2023), but such a consideration is outside of the scope

of this thesis. Only a simple steam production process with natural and a direct fired heater is assumed in this thesis.

It is possible to integrate the capture of CO<sub>2</sub> from flue gas originating from steam generation into the amine carbon capture process at the plant. However, that is not considered in this thesis. Since it is possible that the real-world process would be designed in such a way, the price of CO<sub>2</sub> emission allowances possibly arising from steam generation will not be taken into account in the main techno-economic analysis, although the amount of such CO<sub>2</sub> emissions will be informatively declared for each case and the cost parameter of EUR/CO<sub>2</sub><sub>avoided</sub> is going to be introduced. Of course, such a design would increase the amount of amine, electricity, and steam needed for the process, but it could also result in increased revenue from the additional CO<sub>2</sub> production, although the net financial benefit of such a design is not explored in this thesis.

An alternative to the use of natural gas to produce steam could be to use the temperature of the flue gas from the electricity production process at the LNG terminal to heat up water, and possibly generate steam, before the flue gas enters the absorber. Additional use of the heat of flue gases is one of the working principles of a CHP plant. In the worst case, this could reduce the amount of fossil fuels required for steam generation and, therefore, reduce the CO<sub>2</sub> emissions of the process. There are several other alternatives, which will be mentioned in the next chapter (“6. Further study considerations”).

#### 5.1.9. Removal of NO<sub>x</sub> and PM

Determination of the price of removal of NO<sub>x</sub> and PM in the pre-treatment stage is beyond the scope of this thesis. Presumably, the process equipment is also covered by the 20% increase in the calculated CAPEX. However, a rough estimate can be obtained based on information provided in chapter 4.2. Modelling and simulation.



#### 5.1.10. Final purification

Determination of the price of final purification, for the last 10% of the CO<sub>2</sub> mixture purity, is beyond the scope of this thesis. Presumably, the process equipment is covered by the 20% increase in the calculated CAPEX. Nevertheless, it can be presumed that molecular sieves, active carbon, and cooling could be used for the final purification to remove water and other impurities before compression for pipeline transport or liquefaction and storage (White, 2002; Rai, 2016; Kumar et al., 2010; Meixner et al., 2013).

Dehydration, or the removal of water from the mixture, is an important part of the final purification process in order to lower the dew point before liquefaction of carbon dioxide from the mixture so that there would be no ice, hydrates or free water formation and corrosion in pipelines or pumps and compressors (Kumar et al., 2010; Rai, 2016; White, 2002; Øi et al., 2022) and to remain within product specifications (required purity). Øi et al., 2022 offers a cost estimation of dehydration of CO<sub>2</sub> by TEG and by molecular sieves in Aspen HYSYS.

#### 5.1.11. Storage and transportation

Storage of liquid CO<sub>2</sub> in steel tanks at the plant (the mainland part of the LNG terminal) and transportation of CO<sub>2</sub> as freight (by trucks and/or trains) to wholesale distributors is presumed. Pipeline and CO<sub>2</sub>-carrier (ship) transportation are also possible from the site of the potential project. However, a detailed evaluation of transportation costs is beyond the scope of this thesis. Markov (2022) provides an academic method of estimating the cost of pipeline CO<sub>2</sub> transportation within the scope of a hypothetical CCS project in Croatia.

Furthermore, as previously mentioned in chapter “3. Possible utilizations of the captured CO<sub>2</sub>”, an interactive tool was published in 2023, which presents transportation & storage costs of potential CCS projects in Europe. For included emitters near the LNG terminal (Thermal power plant Plomin and Plomin 2, Rijeka refinery, and Koromačno cement factory), transportation & storage costs are estimated at 20 EUR/tCO<sub>2</sub> for each plant (CATF, 2023b; CATF, 2023a) for pipeline transport. Without the possibility of pipeline transport,

the transportation & storage costs are estimated at 22 EUR/tCO<sub>2</sub> for Thermal power plant Plomin and Plomin 2 and Koromačno cement factory by the tool, while transportation & storage costs remain at 20 EUR/tCO<sub>2</sub> for the Rijeka refinery. If pipeline transport is not available, the tool presumes “*rail, a river barge, or a sea-going ship*” as possible modes of transport (CATF, 2023b). Finally, 20 EUR/tCO<sub>2</sub> is going to be assumed as transportation & storage costs for the project in this thesis. Depending on the delivery point, or point of collection, transportation costs might actually be borne by the buyer, in part or in full.

#### 5.1.12. The price of carbon dioxide

##### 5.1.12.1. *Supply issues*

Prices of CO<sub>2</sub> on the European and American markets have risen significantly from 2021. The CO<sub>2</sub> for industrial uses (described in chapter “3. Possible utilizations of the captured CO<sub>2</sub>”) is often produced as a by-product of an industrial process or from natural CO<sub>2</sub> underground deposits, depending on the region. In Europe, carbon dioxide is largely sourced from ammonia production plants (gasworld, 2022d). In the US, carbon dioxide is largely sourced from bioethanol production plants, in addition to natural underground deposits (gasworld, 2022d; gasworld, 2024e; Irwin, 2024). Bioethanol refers to ethanol produced from agricultural sources (crops), since ethanol can also be produced from petroleum. In any case, certain industrial processes contain a relatively high concentration of carbon dioxide in their by-product streams, as outlined in the chapter on possible utilizations of the captured CO<sub>2</sub>. The CO<sub>2</sub> can then be captured from the mixture of by-product gases, purified, transported, stored, and sold to end-customers.

However, a large number of ammonia plants, which had served as a major source of CO<sub>2</sub> in Europe, have closed in 2021 because of rising natural gas prices (Fertilizers Europe, 2024; U.S. Energy Information Administration, 2022; gasworld, 2021; gasworld, 2022b; Index.hr, 2022), thereby reducing the supply of carbon dioxide in Europe, while demand was retained or even grew (gasworld, 2024a; gasworld, 2024f; gasworld, 2024c), causing a drastic rise in prices of CO<sub>2</sub>. Emerging applications for CO<sub>2</sub>, like green concrete

and e-fuels (e.g. SAF and e-methanol), have the potential to drive the demand for CO<sub>2</sub> up even more in the medium to long term (gasworld, 2024i). 70 - 80% of ammonia plants in the EU closed in 2021 (Fertilizers Europe, 2024; Independent Commodity Intelligence Services, 2022). By 2023, 40 - 50% were still shut down. In 2024, 10 - 20% of EU production remains suspended (Fertilizers Europe, 2024). However, some ammonia plants are still closing down and the fertilizer industry in Europe faces a challenging next several years (S&P Global, 2023; MarketScreener, 2024; de Zeeuw, 2024; Fertilizers Europe, 2024). The price of natural gas has relatively dropped and become stabilized (de Zeeuw, 2024), although it is still higher than pre-2021 levels (de Zeeuw, 2024) and its direction in the future is unknown. The price of natural gas is also significantly higher in Europe than in the US (Argus Media, 2024; de Zeeuw, 2024).

Since the supply of CO<sub>2</sub> is mainly sourced as a by-product of other processes, the supply is overly dependent on other industries, which can cause instabilities and intermittenencies in the supply of carbon dioxide to the market (gasworld, 2024e). What is more, “*ammonia is a seasonal feedstock*” (gasworld, 2022d), important for the production of fertilizers. Each year, ammonia plants go into scheduled maintenance and shutdowns after the fertilizer season (gasworld, 2023; gasworld, 2022d), generally from April to July, while they produce the most from August to March (gasworld, 2022d). Therefore, CO<sub>2</sub> production shortages are already an annual occurrence.

Furthermore, a major supply disruption occurred in the US in 2022 because of a contamination issue with the CO<sub>2</sub> of a large producer which owns the Jackson Dome, a geological formation from which much of the carbon dioxide supply is produced in the US. The CO<sub>2</sub> was contaminated with elevated levels of hydrocarbons, including ethane and benzene, supposedly stemming from the CO<sub>2</sub> producer’s decision to quickly utilise more of its CO<sub>2</sub> supply for EOR projects, amidst a rise in oil and gas prices, while drilling additional wells to cover the rest of the CO<sub>2</sub> market demand (gasworld, 2023; gasworld, 2022c; Bettenhausen, 2022; gasworld, 2022a). Unfortunately, it seemed that the CO<sub>2</sub> produced from new wells had contained more impurities (gasworld, 2023). For several months, buyers were

only able to obtain 30% - 50% of required CO<sub>2</sub> volumes (Bettenhausen, 2022). The producer responded that, while customers had been facing issues with purity, all compositions had been within regulatory and contractual requirements and that it had been the responsibility of gas distributors to address the issues (Bettenhausen, 2022).

Despite all these issues in the past few years, prices and supply of carbon dioxide have somewhat stabilized (gasworld, 2024h; gasworld, 2024e), although prices remain higher than before (gasworld, 2024d) and it cannot be predicted what the situation with the supply and prices would be like in the future (gasworld, 2024i; gasworld, 2024k). Therefore, the CO<sub>2</sub> industry calls for diversification of supply and for more carbon capture and utilization projects (gasworld, 2024g; gasworld, 2024h, gasworld, 2024b). In the light of such a rise in CO<sub>2</sub> prices, the number of carbon capture projects has drastically increased in the last couple of years. In 2023, around 20 CCUS projects in 7 countries reached a final investment decision (FID) and around 110 projects could reach the same stage in 2024 (gasworld, 2024l; IEA, 2024).

The size of the US carbon dioxide market can currently be estimated at around 47 thousand tonnes per day or 17.2 million tonnes per year (Mtpa), based on the information from gasworld, 2024j, which states that a production of 1650 tonnes per day is about 3.5% of the US carbon dioxide market. The food and beverage industry comprises about 70% of the high purity merchant CO<sub>2</sub> demand in the US (gasworld, 2023). Merchant CO<sub>2</sub> is a category “*that includes all industrial uses except for enhanced oil recovery (EOR)*” (Bettenhausen, 2022). CO<sub>2</sub> produced from geological deposits makes up around 24% of the US supply of merchant CO<sub>2</sub>, while production from the Jackson Dome alone contributes around 15% to the overall US merchant CO<sub>2</sub> supply (Bettenhausen, 2022) and the other part of Jackson Dome’s CO<sub>2</sub> production is used for EOR (Vikara et al., 2019).

The yearly demand for carbon dioxide in the EU currently amounts to around 3.5 Mtpa (gasworld, 2024h). The European merchant CO<sub>2</sub> market sources more than 50% of carbon

dioxide from “*fossil-based sources, primarily ammonia*” (gasworld, 2024b; gasworld, 2024h).

#### 5.1.12.2. Prices

CO<sub>2</sub> price quotations for several purities and volumes were obtained in July 2023 from several vendors. Carbon dioxide is often sold in tanks (also known as cylinders) with a certain volume. When the user purchases a cylinder for the first time, the cylinder can come pre-filled with CO<sub>2</sub>. When the tank empties, users can then purchase re-fillings of the CO<sub>2</sub> volume of the tank or exchange the empty cylinder for another filled cylinder from the vendor at the price of a re-filling. Purchasing a new tank, which is pre-filled with carbon dioxide, is more expensive than purchasing only CO<sub>2</sub> (re-fills). The prices outlined in this sub-chapter relate only to purchasing CO<sub>2</sub> itself (or re-fillings of CO<sub>2</sub>). The CO<sub>2</sub> prices are provided without value-added tax (VAT, Cro. PDV), which is applied at the rate of 25% for CO<sub>2</sub> sales in Croatia.

Salona Var d.o.o. sells 40L of food-grade CO<sub>2</sub> (Linde “BIOGON”) at 50.4 EUR and 40L of industrial-grade CO<sub>2</sub> (e.g. for welding) at 34 EUR. A 40-litre tank of CO<sub>2</sub> contains 30 kg of carbon dioxide (Salona Var, 2023; Linde, n.d.-i). Therefore, that is a price of 1.68 EUR/kg (1680 EUR/tonne) for food-grade CO<sub>2</sub> and 1.13 EUR/kg (1130 EUR/tonne) for industrial-grade CO<sub>2</sub>.

Proinstal Škarec d.o.o. sells 10L of CO<sub>2</sub> (both food-grade and industrial) at 32 EUR. A 10-litre tank of CO<sub>2</sub> contains 8 kg of carbon dioxide (Proinstal Škarec, 2023). Therefore, that is a price of 4 EUR/kg (4000 EUR/tonne) of CO<sub>2</sub>. From July 2023, Proinstal Škarec d.o.o. has updated their price of 10 litres of CO<sub>2</sub> to 38.4 EUR (Proinstal Škarec, 2024), which is a price of 4.8 EUR/kg (4800 EUR/tonne).

Messer sells 40L of 2.5 grade CO<sub>2</sub> (99.5% purity) at 34.62 EUR. The 40-litre tank also contains 30 kg of carbon dioxide. Therefore, that is a price of 1.154 EUR/kg (1154

EUR/tonne). Messer sells 40L of food-grade CO<sub>2</sub> (“Gourmet C”) at 54.84 EUR. The 40-litre tank also contains 30 kg of carbon dioxide. Therefore, that is a price of 1.828 EUR/kg (1828 EUR/tonne). Messer sells 50L of 5.5 grade CO<sub>2</sub> (99.9995% purity) at 613.74 EUR. The 50-litre tank contains 37.5 kg of carbon dioxide. Therefore, that is a price of 16.3664 EUR/kg (16.366.4 EUR/tonne) (Messer, 2023a).

GTG plin d.o.o. outlined their CO<sub>2</sub> prices in a table, as shown in Table 5-1 (GTG plin, 2023).

**Table 5-1** Prices of carbon dioxide from GTG plin d.o.o. in 2023

Product	Volume	Mass	Price
CO <sub>2</sub>	40 L	30 kg	0.9954 EUR/kg (995.4 EUR/tonne)
CO <sub>2</sub>	50 L	37.5 kg	1 EUR/kg (1000 EUR/tonne)
CO <sub>2</sub> 4.8 grade	40 L	30 kg	1 EUR/kg (1000 EUR/tonne)
CO <sub>2</sub> FOOD 2	3 L	2.5 kg	3.5384 EUR/kg (3538.4 EUR/tonne)
CO <sub>2</sub> FOOD 2	7 L	5 kg	2.4328 EUR/kg (2432.8 EUR/tonne)
CO <sub>2</sub> FOOD 2	10 L	8 kg	2.0094 EUR/kg (2009.4 EUR/tonne)
CO <sub>2</sub> FOOD 2	14 L	10 kg	1.8794 EUR/kg (1879.4 EUR/tonne)
CO <sub>2</sub> FOOD 2	20 L	15 kg	1.6962 EUR/kg (1696.2 EUR/tonne)
CO <sub>2</sub> FOOD 2	27 L	20 kg	1.6046 EUR/kg (1604.6 EUR/tonne)
CO <sub>2</sub> FOOD 2	Battery (12x37.5 kg)	450 kg	0.95 EUR/kg (950 EUR/tonne)

CO <sub>2</sub>	Battery (12x37.5 kg)	450 kg	1 EUR/kg (1000 EUR/tonne)
CO <sub>2</sub>	Battery (16x40L)	480 kg	1 EUR/kg (1000 EUR/tonne)

An arithmetic mean of the outlined prices, 1.75 EUR/kg (1746.95 EUR/tonne) is going to be considered in this thesis for calculations of financial feasibility. The price of 5.5 grade CO<sub>2</sub> is not considered in the arithmetic average as it is a large outlier value and it is for a specific product. Also, cases with the lowest (0.95 EUR/kg, 950 EUR/tonne) and the highest price (4.8 EUR/kg, 4800 EUR/tonne) are going to be outlined. Furthermore, since it is expected that long-term, and large volume, supply contracts have a lower price, a case with the CO<sub>2</sub> price of 0.5 EUR/kg (500 EUR/tonne) is going to be outlined.

In Germany, even higher prices were observed for CO<sub>2</sub>. For example, a refill of a CO<sub>2</sub> tank of 0.425 kg of CO<sub>2</sub> for personal water carbonators is being sold at 5.0336 EUR (Saturn.de 2024; Sodabaer.de, 2024) and higher (dm.de, 2024; dieschweissprofis.de, 2024) in Germany. This corresponds to a price of 11.8438 EUR/kg (11,843.8 EUR/tonne). A 10 kg refill of food grade CO<sub>2</sub> can be bought at 41.65 EUR (4.165 EUR/kg or 4165 EUR/tonne) (sodao-shop.de., 2024). The CO<sub>2</sub> prices are provided here without VAT, (Ger. *MwSt.*), which is applied at the rate of 19% for CO<sub>2</sub> sales in Germany.

In Switzerland, Linde sells 4.5 grade (99.995% purity), 3.0 grade (99.9% purity), and food-grade CO<sub>2</sub> (Linde “BIOGON”), as shown in Table 5-2:

**Table 5-2** Prices of carbon dioxide from Linde in Switzerland (Linde Gas Schweiz, 2024a; Linde Gas Schweiz, 2024b)

Product	Volume	Mass	Price
CO <sub>2</sub> 3.0 grade	2 L	1.5 kg	49.10 CHF (32.73 CHF/kg; 32,733.33 CHF/tonne)

			(34.76 EUR/kg 34,762.80 EUR/tonne)
CO <sub>2</sub> 3.0 grade	10 L	7.5 kg	52.90 CHF (7.05 CHF/kg 7053.33 CHF/tonne)  (7.49 EUR/kg 7490.64 EUR/tonne)
CO <sub>2</sub> 3.0 grade	20 L	15 kg	73.60 CHF (4.91 CHF/kg 4906.67 CHF/tonne)  (5.21 EUR/kg 5210.88 EUR/tonne)
CO <sub>2</sub> 3.0 grade	40 L	30 kg	135.55 CHF (4.52 CHF/kg 4518.33 CHF/tonne)  (4.80 EUR/kg 4798.47 EUR/tonne)
CO <sub>2</sub> 3.0 grade	50 L	37.5 kg	169.40 CHF (4.52 CHF/kg 4517.33 CHF/tonne)  (4.80 EUR/kg 4797.41 EUR/tonne)
CO <sub>2</sub> 4.5 grade	10 L	7.5 kg	148.50 CHF (19.80 CHF/kg 19,800.00 CHF/tonne)  (21.03 EUR/kg 21,027.60 EUR/tonne)
CO <sub>2</sub> 4.5 grade	40 L	30 kg	387.25 CHF (12.91 CHF/kg 12,908.33 CHF/tonne)  (13.71 EUR/kg 13,708.65 EUR/tonne)
CO <sub>2</sub> BIOGON C 3.0 grade	-	667 kg	2996.50 CHF (4.49 CHF/kg 4492.50 CHF/tonne)



			(4.77 EUR/kg 4771.04 EUR/tonne)
--	--	--	------------------------------------

The middle reference exchange rate from CHF to EUR on 30th August 2024 (1 CHF = 1.062 EUR) from European Central Bank (2024) was used.

Information on CO<sub>2</sub> prices in the US and the UK were also obtained from another researcher in the field and presented in Table 5-3, with a note that the price greatly depends on the distance of the consumer from the source of CO<sub>2</sub> (Mikulandrić, 2023):

**Table 5-3** Prices of certain CO<sub>2</sub> products (Mikulandrić, 2023)

Product type	Price
Liquid CO <sub>2</sub> delivered by trucks (spot price)	From 500 USD/tonne in the US to 2000 EUR/tonne in the UK
Liquid CO <sub>2</sub> delivered by trucks (long-term contracts)	200 EUR/tonne to 300 EUR/tonne
Solid CO <sub>2</sub> (dry ice)	2000 EUR/tonne to 6000 EUR/tonne with delivery
Gaseous CO <sub>2</sub> (in cylinders)	1000 EUR/tonne to 6000 EUR/tonne (with delivery)

## 5.2. First case – MEA 30%

Based on foundational assumptions outlined in chapter “5.1. Foundational assumptions for the economic analysis”, and information obtained from Aspen Process Economic Analyzer, the capital expenditures for the case with 30% MEA (and a 5.36 MJ/kg of CO<sub>2</sub> regeneration energy) are presented in Table 5-4.

**Table 5-4** Capital expenditures in the first case

Equipment	Price (EUR)	Total direct cost (EUR)
Absorber	471,200.00	779,000.00
Desorber	141,000.00	565,300.00
High-temperature fan	161,487.94	161,487.94
High-temperature fan 2	161,487.94	161,487.94
Lean/rich heat exchanger (E-104)	58,200.00	179,000.00
Water pump 1 (P-100)	22,900.00	121,000.00
Rich amine pump (P-102)	9800.00	64,400.00
Water pump 2 (P-100-2)	17,500.00	81,900.00
Make-up water pump (P-100-2-2)	5120.00	35,200.00
Regenerated amine pump (P-103)	9,800.00	64,400.00
Main stream cooler	94,300.00	390,600.00
Regenerated amine cooler (E-105)	27,900.00	113,600.00
Separator (V-100)	24,900.00	150,400.00
MEA (starting stream)	15,000.00 kg at 2.45 EUR/kg	36,750.00

Water (starting stream)	33,199.94 kg at 0.0002665064 EUR/kg	8.85
-------------------------	--	------

The “Price” column refers to the cost of a piece of equipment, while the “Total direct cost” column refers to the complete costs associated with the equipment’s installation. Therefore, the capital expenditure for the project is 2,904,534.73 EUR.

Applying the CEPCI to account for inflation in the chemical engineering sector, as described in chapter “5.1.1 Capital expenditures (CAPEX) and operating expenditures (OPEX)”, the capital expenditure is actually slightly reduced to 2,843,311.69 EUR.

After applying the 20% increase to better account for the cost of other equipment and capital costs, as recommended by Orangi (2021), the CAPEX amounts to 3,411,974.03 EUR.

As indicated by Orangi (2021) and Razzaghianarmarzi (2024), there is a method that can be applied manually to equipment costs obtained from HYSYS in order to arrive at a better estimation of equipment installations costs (or “total direct costs”), such as the enhanced detail factor method (EDF). The EDF method allows for a more detailed manual design of process equipment with different materials.

It should be noted that the costs of design, engineering, procurement, and construction are not covered in this thesis. APEA states that the total capital cost of the project is 8,672,320 EUR, which is a figure that includes both total installed costs of equipment and the engineering and construction costs, as well as certain other cost categories, although no other data was specified for the economic analyser other than those mentioned in this thesis.

HYSYS (or APEA) could not estimate the cost of the two fans, since it does not have a high-temperature industrial fan model. Therefore, the power law method of cost estimation was used, as described by Orangi (2021), Razzaghianarmarzi (2024), and Smith (2005), based on the flue gas molar flow from the base case of Orangi (2021) and the scaling factor (exponential size factor,  $e$ ) of 0.65.

Based on foundational assumptions outlined in chapter “5.1. Foundational assumptions for the economic analysis”, and information obtained from Aspen Process Economic Analyzer, the operating expenditures for the case with 30% MEA (and a 5.36 MJ/kg of CO<sub>2</sub> regeneration energy) are presented in Table 5-5.

**Table 5-5** Yearly operating expenditures in the first case

Utility or material	Unit price	Required number of units	Yearly price
Electricity	0.2192 EUR/kWh	5,082,579.59 kWh	1,114,101.45 EUR
MEA make-up	2.45 EUR/kg	12.09 kg/hr	254,677.06 EUR
Make-up water	0.0002665064 EUR/kg	4088.90 kg/hr	9369.40 EUR
Steam	24.77 EUR/tonne	8.031 tonne/hr	1,710,168.85 EUR
Transportation costs	20 EUR/tonne	28,284.75 tonnes	565,694.92 EUR
Maintenance costs	4% of CAPEX	1	136,478.96 EUR

The required electrical energy is based on the total electricity duty of 591.135 kW, declared in chapter 4, and the yearly number of working hours of the plant. The same procedure is applied for other utilities in the table. The total yearly operating expenditure (OPEX) is 3,790,490.64 EUR. Therefore, the total cost (capital expenditure + operating expenditure) over 25 years of the project would be 98,174,240.03 EUR.

CO<sub>2</sub> makes up 90.73% mass in the “Dehydrated CO<sub>2</sub>” stream, which amounts to 3289.689 kg/hr. Therefore, the yearly amount of produced CO<sub>2</sub> in the project would be 28,284,746.022 kg or 28,284.75 tonnes. Therefore, the total amount of produced CO<sub>2</sub> over

25 years of the project would be 707,118,650.55 kg or 707,118.65 tonnes. Then, the cost of CO<sub>2</sub> capture would be 0.14 EUR/kg or 138.84 EUR/tonne.

With transportation costs not borne by the producer at all, the cost of CO<sub>2</sub> capture would be 0.12 EUR/kg or 118.84 EUR/tonne. Without the cost of steam, as outlined in chapter “5.1.8. The price of steam”, the cost of CO<sub>2</sub> capture would be 0.08 EUR/kg or 78.37 EUR/tonne. Without the cost of steam and without the cost of transportation, the cost of CO<sub>2</sub> capture would be 0.06 EUR/kg or 58.37 EUR/tonne.

Based on foundational assumptions outlined in chapter “5.1. Foundational assumptions for the economic analysis”, the yearly gross incomes possible for the case with 30% MEA (and a 5.36 MJ/kg of CO<sub>2</sub> regeneration energy) are presented in Table 5-6.

**Table 5-6** Yearly gross incomes possible for the first case

CO <sub>2</sub> production rate (kg/hr)	Price of CO <sub>2</sub> (EUR/kg)	Yearly income (EUR)
3289.689	0.5	14,142,373.01
3289.689	0.95	26,870,508.72
3289.689	1.75	49,498,305.54
3289.689	4.8	135,766,780.91

Based on the capital expenditure (CAPEX) of 3,411,974.03 EUR, yearly operating expenditure (OPEX) of 3,790,490.64 EUR, the price of CO<sub>2</sub> of 1.75 EUR/kg, and the discount rate of 7%, the NPV can then be calculated as 529,247,848.78 EUR with the Equation 5-2, as shown in Table 5-7.

**Table 5-7** NPV calculation table for the first case

Year	OPEX (EUR)	Gross income (EUR)	Cash flow (EUR)	Discounted cashflow (EUR)	NPV (EUR)
0			-3,411,974.03	-3,411,974.03	-3,411,974.03
1	-3,790,490.64	49,498,305.54	45,707,814.90	42,717,584.02	39,305,609.98
2	-3,790,490.64	49,498,305.54	45,707,814.90	39,922,975.72	79,228,585.70
3	-3,790,490.64	49,498,305.54	45,707,814.90	37,311,192.26	116,539,777.96
4	-3,790,490.64	49,498,305.54	45,707,814.90	34,870,273.14	151,410,051.10
5	-3,790,490.64	49,498,305.54	45,707,814.90	32,589,040.32	183,999,091.42
6	-3,790,490.64	49,498,305.54	45,707,814.90	30,457,047.03	214,456,138.44
7	-3,790,490.64	49,498,305.54	45,707,814.90	28,464,529.93	242,920,668.37
8	-3,790,490.64	49,498,305.54	45,707,814.90	26,602,364.42	269,523,032.79
9	-3,790,490.64	49,498,305.54	45,707,814.90	24,862,022.82	294,385,055.62
10	-3,790,490.64	49,498,305.54	45,707,814.90	23,235,535.35	317,620,590.96
11	-3,790,490.64	49,498,305.54	45,707,814.90	21,715,453.60	339,336,044.56
12	-3,790,490.64	49,498,305.54	45,707,814.90	20,294,816.45	359,630,861.01
13	-3,790,490.64	49,498,305.54	45,707,814.90	18,967,118.17	378,597,979.18
14	-3,790,490.64	49,498,305.54	45,707,814.90	17,726,278.67	396,324,257.85
15	-3,790,490.64	49,498,305.54	45,707,814.90	16,566,615.58	412,890,873.42
16	-3,790,490.64	49,498,305.54	45,707,814.90	15,482,818.30	428,373,691.72
17	-3,790,490.64	49,498,305.54	45,707,814.90	14,469,923.64	442,843,615.36
18	-3,790,490.64	49,498,305.54	45,707,814.90	13,523,293.12	456,366,908.48
19	-3,790,490.64	49,498,305.54	45,707,814.90	12,638,591.70	469,005,500.19
20	-3,790,490.64	49,498,305.54	45,707,814.90	11,811,767.95	480,817,268.13
21	-3,790,490.64	49,498,305.54	45,707,814.90	11,039,035.46	491,856,303.60
22	-3,790,490.64	49,498,305.54	45,707,814.90	10,316,855.57	502,173,159.17
23	-3,790,490.64	49,498,305.54	45,707,814.90	9,641,921.10	511,815,080.27
24	-3,790,490.64	49,498,305.54	45,707,814.90	9,011,141.21	520,826,221.48
25	-3,790,490.64	49,498,305.54	45,707,814.90	8,421,627.30	<b>529,247,848.78</b>

Additionally, the NPV for the case with the price of 0.5 EUR/kg is 117,224,548.23 EUR. The NPV for the case with the price of 0.95 EUR/kg is 265,552,936.43 EUR. Finally, the NPV for the case with the price of 4.8 EUR/kg is 1,534,584,702.13 EUR.

The minimum price of CO<sub>2</sub> required for the project to break even after 25 years (NPV = 0 EUR) is 0.14 EUR/kg or 144.36 EUR/tonne, obtained with the “What-If analysis” function in Excel. The yearly gross income in that case should be only 4,083,273.90 EUR.

The amount of natural gas required for amine regeneration in this case, based on equation (5-7) and division by 0.9, is 4,064,636.53 m<sup>3</sup>. If the terminal could not cover any of that amount from the boil-off gas, the yearly cost at the price of 41 EUR/MWh (approximately the price on CEGH on 1<sup>st</sup> September 2024) would be 1,918,975.88 EUR. It should be noted that this cost is already accounted for with the cost of steam in this thesis. In fact, it is very close to the figure outlined in chapter “5.1.8. The price of steam”.

The corresponding CO<sub>2</sub> emissions from the amine regeneration process, based on the CO<sub>2</sub> emissions factor of natural gas of 56.1 tonnes CO<sub>2</sub>/TJ and an HHV of 11.515 kWh/m<sup>3</sup>, are then 9452.59 tonnes/year. If CO<sub>2</sub> emissions would have to be paid for in the EU ETS system, their yearly cost would amount to 756,207.55 EUR/year, with a presumed CO<sub>2</sub> allowance price of 80 EUR/tonne.

The CO<sub>2</sub> emitted with the clean gas (the “Clean gas” stream) amounts to 563.81 kg/hr and, therefore, 4,847,638.38 kg/year (4847.64 tonne/year). If these CO<sub>2</sub> emissions would have to be paid for in the EU ETS system, their yearly cost would amount to 387,760.00 EUR/year, with a presumed CO<sub>2</sub> allowance price of 80 EUR/tonne.

Taking into consideration the CO<sub>2</sub> emissions from the reboiler, and the “cleaned” gas, the possible cost of carbon capture would then be 0.18 EUR/kg (179.28 EUR/tonne), after adding these costs to the yearly operational costs. This cost could be referred to as the “CO<sub>2</sub> avoided” cost, although the CO<sub>2</sub> avoided cost is usually calculated by subtracting the amount of emissions generated by the carbon capture process from the captured (i.e. produced) CO<sub>2</sub> amount, instead of adding the monetary values (IISD, 2023). The cost of 0.14 EUR/kg (138.84 EUR/tonne) can be referred to as the “CO<sub>2</sub> captured” cost.

As laid out in chapter “1. Introduction”, it is possible to exclude an installation from the EU ETS under criteria laid out in Article 27 and 27a of the Directive 2003/87/EC (OJ, Series L 275, 25.10.2003) and under criteria laid out in transposed Croatian national legislation (Article 39 and Article 40 of the Act on Climate Change and Ozone Layer Protection (OG 127/19) and Article 11 and Article 12 of the Regulation on trading greenhouse gas emission allowances). Most notably, Article 27 of the Directive states that “*Following consultation with the operator, Member States may exclude from the EU ETS installations which have reported to the competent authority emissions of less than 25 000 tonnes of carbon dioxide equivalent and, where they carry out combustion activities, have a rated thermal input below 35 MW,(...)*”, while Article 27a of the Directive states that “*Member States may exclude from the EU ETS installations that have reported to the competent authority of the Member State concerned emissions of less than 2 500 tonnes of carbon dioxide equivalent(...)*” (OJ, Series L 275, 25.10.2003).

Additionally, CCU plants might be exempted from the EU ETS, depending on the nature of the utilization and the duration of storage of the CO<sub>2</sub> in the end-product, although the emissions legislation on the EU level for such plants is still not complete (Publyon, 2024). It is also not clear whether emissions from the capture process would still be counted towards the EU ETS or not, and under what conditions, in case of a CCU plant, although it is probable that the real-world process would be designed in such a way that the CO<sub>2</sub> originating from the capture process would also be captured anyway, as outlined in chapter “5.1.8. The price of steam”.



### 5.3. Second case – MEA 30% and 3.83 MJ/kgCO<sub>2</sub> regeneration energy

CAPEX for the second case is presented in Table 5-8.

**Table 5-8** Capital expenditures in the second case

Equipment	Price (EUR)	Total direct cost (EUR)
Absorber	471,200.00	779,000.00
Desorber	557,700.00	1,101,800.00
High-temperature fan	161,487.94	161,487.94
High-temperature fan 2	161,487.94	161,487.94
Lean/rich heat exchanger (E-104)	202,800.00	385,300.00
Water pump 1 (P-100)	22,900.00	121,000.00
Rich amine pump (P-102)	11,300.00	66,000.00
Water pump 2 (P-100-2)	17,500.00	81,900.00
Make-up water pump (P- 100-2-2)	5000.00	31,100.00
Main stream cooler	94,300.00	390,600.00
Regenerated amine cooler (E-105)	31,900.00	117,700.00
Separator (V-100)	24,900.00	150,400.00
MEA (starting stream)	15,000.00 kg at 2.45 EUR/kg	51,817.50
Water (starting stream)	33,199.94 kg at 0.0002665064 EUR/kg	11.99

The “Price” column refers to the cost of a piece of equipment, while the “Total direct cost” column refers to the complete costs associated with the equipment’s installation. Therefore, the capital expenditure for the project is 3,599,605.37 EUR.

Applying the CEPCI to account for inflation in the chemical engineering sector, the capital expenditure is actually slightly reduced to 3,523,731.34 EUR.

After applying the 20% increase to better account for the cost of other equipment and capital costs, as recommended by Orangi (2021), the CAPEX amounts to 4,228,477.61 EUR.

It should be noted that the costs of design, engineering, procurement, and construction are not covered in this thesis. APEA states that the total capital cost of the project is 9,973,720 EUR, which is a figure that includes both total installed costs of equipment and the engineering and construction costs, as well as certain other cost categories, although no other data was specified for the economic analyser other than those mentioned in this thesis.

OPEX for the second case is presented in Table 5-9.

**Table 5-9** Yearly operating expenditures in the second case

Utility or material	Unit price	Required number of units	Yearly price
Electricity	0.2192 EUR/kWh	5,106,541.11 kWh	1,119,353.81 EUR
MEA make-up	2.45 EUR/kg	44,090.54 kg	108,021.83 EUR
Make-up water	0.0002665064 EUR/kg	15,564,185.58 kg	4147.96 EUR
Steam	24.77 EUR/tonne	42,968.47 tonnes	1,064,328.96 EUR
Transportation costs	20 EUR/tonne	24,635.71 tonnes	492,714.17 EUR
Maintenance costs	4% of CAPEX	1.00	169,139.10 EUR

The required electrical energy is based on the total electricity duty of 593.922 kW, declared in chapter 4, and the yearly number of working hours of the plant. The same procedure is applied for other utilities in the table. The total yearly operating expenditure

(OPEX) is 2,957,705.84 EUR. Therefore, the total cost (capital expenditure + operating expenditure) over 25 years of the project would be 78,171,123.55 EUR.

CO<sub>2</sub> makes up 95.33% mass in the “Dehydrated CO<sub>2</sub>” stream, which amounts to 2865.28 kg/hr. Therefore, the yearly amount of produced CO<sub>2</sub> in the project would be 24,635,708.53 kg or 24,635.71 tonnes. Therefore, the total amount of produced CO<sub>2</sub> over 25 years of the project would be 615,892,713.26 kg or 615,892.71 tonnes. Then, the cost of CO<sub>2</sub> capture would be 0.13 EUR/kg or 126.92 EUR/tonne.

With transportation costs not borne by the producer at all, the cost of CO<sub>2</sub> capture would be 0.11 EUR/kg or 106.92 EUR/tonne. Without the cost of steam, as outlined in chapter “5.1.8. The price of steam”, the cost of CO<sub>2</sub> capture would be 0.08 EUR/kg or 83.72 EUR/tonne. Without the cost of steam and without the cost of transportation, the cost of CO<sub>2</sub> capture would be 0.06 EUR/kg or 63.72 EUR/tonne.

The yearly gross incomes possible for the second case are presented in Table 5-10.

**Table 5-10** Yearly gross incomes possible for the second case

CO <sub>2</sub> production rate (kg/hr)	Price of CO <sub>2</sub> (EUR/kg)	Yearly income (EUR)
2865.28	0.5	12,317,838.720
2865.28	0.95	43,112,435.520
2865.28	1.75	23,403,893.568
2865.28	4.8	118,251,251.712

Based on the capital expenditure (CAPEX) of 4,228,477.61 EUR, yearly operating expenditure (OPEX) of 2,957,705.84 EUR, the price of CO<sub>2</sub> of 1.75 EUR/kg, and the

discount rate of 7%, the NPV can then be calculated as 463,718,004.75 EUR, as shown in Table 5-11.

**Table 5-11** NPV calculation table for the second case

Year	OPEX (EUR)	Gross income (EUR)	Cash flow (EUR)	Discounted cashflow (EUR)	NPV (EUR)
<b>0</b>			-4,228,477.61	-4,228,477.61	-4,228,477.61
<b>1</b>	-2,957,705.84	43,112,435.52	40,154,729.68	37,527,784.75	33,299,307.14
<b>2</b>	-2,957,705.84	43,112,435.52	40,154,729.68	35,072,696.03	68,372,003.17
<b>3</b>	-2,957,705.84	43,112,435.52	40,154,729.68	32,778,220.59	101,150,223.76
<b>4</b>	-2,957,705.84	43,112,435.52	40,154,729.68	30,633,851.02	131,784,074.77
<b>5</b>	-2,957,705.84	43,112,435.52	40,154,729.68	28,629,767.30	160,413,842.08
<b>6</b>	-2,957,705.84	43,112,435.52	40,154,729.68	26,756,791.87	187,170,633.95
<b>7</b>	-2,957,705.84	43,112,435.52	40,154,729.68	25,006,347.55	212,176,981.50
<b>8</b>	-2,957,705.84	43,112,435.52	40,154,729.68	23,370,418.27	235,547,399.76
<b>9</b>	-2,957,705.84	43,112,435.52	40,154,729.68	21,841,512.40	257,388,912.16
<b>10</b>	-2,957,705.84	43,112,435.52	40,154,729.68	20,412,628.41	277,801,540.57
<b>11</b>	-2,957,705.84	43,112,435.52	40,154,729.68	19,077,222.81	296,878,763.38
<b>12</b>	-2,957,705.84	43,112,435.52	40,154,729.68	17,829,180.20	314,707,943.58
<b>13</b>	-2,957,705.84	43,112,435.52	40,154,729.68	16,662,785.23	331,370,728.82
<b>14</b>	-2,957,705.84	43,112,435.52	40,154,729.68	15,572,696.48	346,943,425.29
<b>15</b>	-2,957,705.84	43,112,435.52	40,154,729.68	14,553,921.94	361,497,347.24
<b>16</b>	-2,957,705.84	43,112,435.52	40,154,729.68	13,601,796.21	375,099,143.45
<b>17</b>	-2,957,705.84	43,112,435.52	40,154,729.68	12,711,959.07	387,811,102.52
<b>18</b>	-2,957,705.84	43,112,435.52	40,154,729.68	11,880,335.58	399,691,438.10
<b>19</b>	-2,957,705.84	43,112,435.52	40,154,729.68	11,103,117.37	410,794,555.47
<b>20</b>	-2,957,705.84	43,112,435.52	40,154,729.68	10,376,745.20	421,171,300.67
<b>21</b>	-2,957,705.84	43,112,435.52	40,154,729.68	9,697,892.71	430,869,193.39
<b>22</b>	-2,957,705.84	43,112,435.52	40,154,729.68	9,063,451.13	439,932,644.52
<b>23</b>	-2,957,705.84	43,112,435.52	40,154,729.68	8,470,515.08	448,403,159.60
<b>24</b>	-2,957,705.84	43,112,435.52	40,154,729.68	7,916,369.23	456,319,528.83
<b>25</b>	-2,957,705.84	43,112,435.52	40,154,729.68	7,398,475.92	<b>463,718,004.75</b>

Additionally, the NPV for the case with the price of 0.5 EUR/kg is 104,850,609.50 EUR. The NPV for the case with the price of 0.95 EUR/kg is 234,042,871.79 EUR. Finally, the NPV for the case with the price of 4.8 EUR/kg is 1,339,354,449.16 EUR.

The minimum price of CO<sub>2</sub> required for the project to break even after 25 years (NPV = 0 EUR) is 0.13 EUR/kg or 134.79 EUR/tonne, obtained with the “What-If analysis” function in Excel. The yearly gross income in that case should be only 3,320,553.69 EUR.

The amount of natural gas required for amine regeneration in this case, based on equation (5-7) and division by 0.9, is 2,529,602.93 m<sup>3</sup>. If the terminal could not cover any of that amount from the boil-off gas, the yearly cost at the price of 41 EUR/MWh (approximately the price on CEGH on 1<sup>st</sup> September 2024) would be 1,194,263.49 EUR. It should be noted that this cost is already accounted for with the cost of steam in this thesis. In fact, it is very close to the figure outlined in chapter “5.1.8. The price of steam” and calculated for this case.

The corresponding CO<sub>2</sub> emissions from the amine regeneration process, based on the CO<sub>2</sub> emissions factor of natural gas of 56.1 tonnes CO<sub>2</sub>/TJ and an HHV of 11.515 kWh/m<sup>3</sup>, are then 5882.77 tonnes/year. If CO<sub>2</sub> emissions would have to be paid for in the EU ETS system, their yearly cost would amount to 470,621.37 EUR/year, with a presumed CO<sub>2</sub> allowance price of 80 EUR/tonne.

The CO<sub>2</sub> emitted with the clean gas (the “Clean gas” stream) amounts to 992.62 kg/hr and, therefore, 8,534,515.08 kg/year (8534.52 tonne/year). If these CO<sub>2</sub> emissions would have to be paid for in the EU ETS system, their yearly cost would amount to 682,761.21 EUR/year, with a presumed CO<sub>2</sub> allowance price of 80 EUR/tonne.

Taking into consideration the CO<sub>2</sub> emissions from the reboiler, and the “cleaned” gas, the possible cost of carbon capture would then be 0.17 EUR/kg (173.74 EUR/tonne), after adding these costs to the yearly operational costs. This cost could be referred to as the “CO<sub>2</sub> avoided” cost, although the CO<sub>2</sub> avoided cost is usually calculated by subtracting the amount of emissions generated by the carbon capture process from the captured (i.e. produced) CO<sub>2</sub> amount, instead of adding the monetary values (IISD, 2023). The cost of 0.13 EUR/kg (126.92 EUR/tonne) can be referred to as the “CO<sub>2</sub> captured” cost. It is probable that the real-world process would be designed in such a way that the CO<sub>2</sub> originating from the

capture process would be captured anyway, as outlined in chapter “5.1.8. The price of steam”.

#### 5.4. Third case – MEA 40% with 99% capture efficiency and 99% product purity

The economic analysis of the third case is going to be described just briefly. CAPEX for the third case is 4,624,432.10 EUR. The same cost for a single fan was used as in the previous two cases. Heating of the water wash stream was not considered towards CAPEX or OPEX. By applying the CEPCI to account for inflation in the chemical engineering sector, the capital expenditure is actually slightly reduced to 4,526,956.33 EUR. After applying the 20% increase to better account for the cost of other equipment and capital costs, as recommended by Orangi (2021), the CAPEX amounts to 5,432,347.59 EUR.

It should be noted that the costs of design, engineering, procurement, and construction are not covered in this thesis. APEA states that the total capital cost of the project is 11,549,500 EUR, which is a figure that includes both total installed costs of equipment and the engineering and construction costs, as well as certain other cost categories, although no other data was specified for the economic analyser other than those mentioned in this thesis.

OPEX for the third case is presented in Table 5-12.

**Table 5-12** Yearly operating expenditures in the third case

Utility or material	Unit price	Required number of units	Yearly price
Electricity	0.2192 EUR/kWh	1,829,410.00 kWh	401,006.67 EUR
MEA make-up	2.45 EUR/kg	71,853.49 kg	176,041.04 EUR
Make-up water	0.0002665064 EUR/kg	8,688,794.69 kg	2315.62 EUR
Steam	24.77 EUR/tonne	137,010.56 tonnes	3,393,751.63 EUR
Transportation costs	20 EUR/tonne	24,635.71 tonnes	492,714.17 EUR
Maintenance costs	4% of CAPEX	1.00	217,293.90 EUR

The total yearly operating expenditure (OPEX) is 4,683,123.04 EUR. Therefore, the total cost (capital expenditure + operating expenditure) over 25 years of the project would be 122,510,423.56 EUR.

CO<sub>2</sub> makes up 95.33% mass in the “Clean CO<sub>2</sub>” stream, which amounts to 3835.07 kg/hr. Therefore, the yearly amount of produced CO<sub>2</sub> in the project would be 32,973,898.96 kg or 32,973.90 tonnes. Therefore, the total amount of produced CO<sub>2</sub> over 25 years of the project would be 824,347,474.09 kg or 824,347.47 tonnes. Then, the cost of CO<sub>2</sub> capture would be 0.15 EUR/kg or 148.62 EUR/tonne.

With transportation costs not borne by the producer at all, the cost of CO<sub>2</sub> capture would be 0.13 EUR/kg or 133.67 EUR/tonne. Without the cost of steam, as outlined in chapter “5.1.8. The price of steam”, the cost of CO<sub>2</sub> capture would be 0.05 EUR/kg or 45.69 EUR/tonne. Without the cost of steam and without the cost of transportation, the cost of CO<sub>2</sub> capture would be 0.03 EUR/kg or 30.75 EUR/tonne.

The yearly gross incomes possible for the second case are presented in Table 5-13.

**Table 5-13** Yearly gross incomes possible for the third case

CO <sub>2</sub> production rate (kg/hr)	Price of CO <sub>2</sub> (EUR/kg)	Yearly income (EUR)
3835.07	0.5	16,486,949.48
3835.07	0.95	57,704,323.19
3835.07	1.75	31,325,204.02
3835.07	4.8	158,274,715.03

Based on the capital expenditure (CAPEX) of 5,432,347.59 EUR, yearly operating expenditure (OPEX) of 4,683,123.04 EUR, the price of CO<sub>2</sub> of 1.75 EUR/kg, and the discount rate of 7%, the NPV can then be calculated as 612,454,618.54 EUR. Additionally, the NPV for the case with the price of 0.5 EUR/kg is 132,124,525.69 EUR. The NPV for the case with the price of 0.95 EUR/kg is 305,043,359.11 EUR. Finally, the NPV for the case with the price of 4.8 EUR/kg is 1,784,460,045.11 EUR.

The minimum price of CO<sub>2</sub> required for the project to break even after 25 years (NPV = 0 EUR) is 0.16 EUR/kg or 156.16 EUR/tonne, obtained with the “What-If analysis function in Excel. The yearly gross income in that case should be only 5,149,275.60 EUR.

The amount of natural gas required for amine regeneration in this case, based on equation (5-7) and division by 0.9, is 8,065,968.69 m<sup>3</sup>. If the terminal could not cover any of that amount from the boil-off gas, the yearly cost at the price of 41 EUR/MWh (approximately the price on CEGH on 1<sup>st</sup> September 2024) would be 3,808,064.81 EUR. It should be noted that this cost is already accounted for with the cost of steam in this thesis. In fact, it is very close to the figure outlined in chapter “5.1.8. The price of steam” and calculated for this case.

The corresponding CO<sub>2</sub> emissions from the amine regeneration process, based on the CO<sub>2</sub> emissions factor of natural gas of 56.1 tonnes CO<sub>2</sub>/TJ and an HHV of 11.515 kWh/m<sup>3</sup>, are then 18,757.97 tonnes/year. If CO<sub>2</sub> emissions would have to be paid for in the EU ETS system, their yearly cost would amount to 1,500,637.60 EUR/year, with a presumed CO<sub>2</sub> allowance price of 80 EUR/tonne.

The CO<sub>2</sub> emitted with the clean gas (the “Clean gas” stream) amounts to 21.55 kg/hr and, therefore, 185,277.82 kg/year (185.28 tonne/year). If these CO<sub>2</sub> emissions would have to be paid for in the EU ETS system, their yearly cost would amount to 14,822.23 EUR/year, with a presumed CO<sub>2</sub> allowance price of 80 EUR/tonne.

Taking into consideration the CO<sub>2</sub> emissions from the reboiler, and the “cleaned” gas, the possible cost of carbon capture would then be 0.19 EUR/kg (194.57 EUR/tonne), after



adding these costs to the yearly operational costs. This cost could be referred to as the “CO<sub>2</sub> avoided” cost. The cost of 0.15 EUR/kg (148.62 EUR/tonne) can be referred to as the “CO<sub>2</sub> captured” cost. It is probable that the real-world process would be designed in such a way that the CO<sub>2</sub> originating from the capture process would be captured anyway, as outlined in chapter “5.1.8. The price of steam”.

## 6. FURTHER STUDY CONSIDERATIONS

Anything that has been mentioned to be outside of the scope of this thesis could be grounds for further research. Lowering the cost of carbon capture can be explored through different optimizations of the process in HYSYS, such as vapour recompression (Orangi, 2021; Razzaghianarmarzi, 2024), using a water wash in the absorber, reusing water from the condenser and the separator (and, perhaps, from the final purification process) for the water wash and the amine make-up, etc. Different amines, additives, certain amine blends, and solution concentrations could also be considered, as these have shown to be able to reduce the reboiler energy required for regeneration of the amine (Orangi, 2021).

Specific cost of a pipeline for a carbon capture project could be included in future research, as described by Markov (2022). The cost of different transport modalities might also be assessed, such as trains, trucks, and ships, as constructing a pipeline might not be a viable option for some emitters. There has already been an interest in alternative transport options in the Croatian region (Bellona, 2022). CO<sub>2</sub> carriers (ships) might play an important role in future carbon capture projects, as there are several carriers being built right now (Bond, 2024; upstreamonline.com, 2022), although this will depend on actually implemented projects. Several emitters could also work together to secure a good transportation deal. Further research could try to include estimation of the size of a considered carbon capture plant, as it is not possible to automatically estimate the area of a plant in Aspen HYSYS and some emitters might not have enough space for such an installation.

If an emitter from the Croatian coastal region would not invest in a CO<sub>2</sub> utilization project, and would rather hedge the cost of emissions with a CO<sub>2</sub> storage project, it could be an option to join the CCS Ravenna project. CCS Ravenna is going to store CO<sub>2</sub> from hard-to-abate sectors in a depleted natural gas field below the Adriatic Sea off the coast of Ravenna, Italy (Eni and Snam, 2024).

For more accurate results, heat exchangers could be rigorously modelled in dedicated programs, like ASPEN Exchanger Design and Rating (EDR). Other packing materials might also be considered. For example, it has been shown that 3D printed polymer packing could potentially replace conventional steel packing in the absorption process, which could help reduce high capital costs of the process (Chai et al., 2022).

Regarding the kind of plant considered in this thesis, it might be interesting to evaluate incorporating a cryogenic carbon capture plant at the LNG terminal or even an air separation plant, although there are other options for utilization of the cold energy as well (Noor Akashah et al., 2023; Lebedevas and Malūkas, 2024; Mikulić, 2023).

Other energy sources could be considered for steam generation in order to regenerate the amine in the stripper. For example, it has been proposed that deep geothermal energy might be used for steam generation instead of fossil fuels (Van Wagener et al., 2013; F. Wang et al., 2017), although such an option would depend on the availability of geothermal energy. Concentrated solar power was also proposed to alleviate steam generation costs. It could also be possible to combine multiple alternative sources of energy with auxiliary traditional sources (F. Wang et al., 2017; Y. Wu et al., 2022; Quang et al., 2023). Optimal selection of the source of energy for solvent regeneration is a current topic of research in the field of carbon capture (Y. Wu et al., 2022; F. Wang et al., 2017; Van Wagener et al., 2013; Quang et al., 2023).

Other kinds of carbon capture technologies could be considered, such as those presented in chapter “2. Carbon dioxide emissions reduction technologies”, although cost estimation for such methods can be difficult. Wärtsilä has been testing an onboard carbon capture system, which should be commercialised after a pilot installation (Wärtsilä, 2024b).

## 7. CONCLUSION

Since the price of carbon dioxide has become high enough in the past few years, this thesis has shown that it is now profitable to invest into post-combustion carbon capture on the example of flue gases from the Croatian LNG terminal. For the first case, a production price of 138.84 EUR/tonne CO<sub>2</sub> was calculated and an NPV of 529,247,849 EUR was calculated for the base selling price of 1.75 EUR/kg CO<sub>2</sub>. For the second case, a production price of 126.92 EUR/tonne CO<sub>2</sub> was calculated and an NPV of 463,718,005 EUR was calculated for the base selling price of 1.75 EUR/kg CO<sub>2</sub>. For the third case, a production price of 148.62 EUR/tonne CO<sub>2</sub> was calculated and an NPV of 612,454,619 EUR was calculated for the base selling price of 1.75 EUR/kg CO<sub>2</sub>. It has also been shown that spending more heat energy to achieve extra CO<sub>2</sub> recovery (i.e. having a larger regeneration energy) can pay off in terms of a significant NPV increase, if CO<sub>2</sub> is captured for a purpose with a potential positive revenue.

Therefore, it is possible that the number of investment decisions into pure CCS plants will be lower in the short to medium term, except if aided by subsidies in the US and the EU and by unfavourable CCU legislation, while it is impossible to predict carbon dioxide prices in the long-term with a high degree of confidence. Despite stabilized supply, a higher-than-before price of CO<sub>2</sub> currently remains in the market because traditional CO<sub>2</sub> producers (e.g. ammonia plants) have still not recuperated fully from the plant closures, while natural gas prices remain up as well. A larger number of post-combustion carbon capture and utilization plants are expected to come online in the medium term since many projects have entered serious planning and implementation stages in the last year. Also, a rise in the volume of CO<sub>2</sub> trading and transportation can be expected in the long-term, with more than a few CO<sub>2</sub> carriers currently being built and several CO<sub>2</sub> terminals planned.

Carbon dioxide already has many applications and a high degree of importance for the economy, while there are still emerging markets for CO<sub>2</sub> with a much greater potential demand in the future and the requirement to ensure a stable supply to the market.

## 8. REFERENCES

1. ABDULLAH, S. 2023. *Advantages of using Aspen Hysys and Aspen Plus Software in Process Design*. <https://www.linkedin.com/pulse/advantages-using-aspen-hysys-plus-software-process-design-abdullah/> (12.07.2023)
2. ACP. 2014. *Dry Ice for transporting pharmaceutical products*. <https://www.acpco2.com/en/chemical-industry/dry-ice-transporting-pharmaceutical-products> (12.04.2023)
3. AEROQUAL. 2024. *A Beginner's Guide to NOx, NO and NO2 as Air Pollutants*. <https://www.aeroqual.com/blog/meet-the-nitrogen-oxide-family> (25.08.2024)
4. AGBONGHAE, E. O., HUGHES, K. J., INGHAM, D. B., MA, L., POURKASHANIAN, M. 2014. *Optimal Process Design of Commercial-Scale Amine-Based CO2 Capture Plants*. *Industrial and Engineering Chemistry Research*, 53(38), 14815–14829. <https://doi.org/10.1021/ie5023767>
5. AIR LIQUIDE. 2024. *Gas Encyclopedia - Carbon dioxide*. <https://encyclopedia.airliquide.com/carbon-dioxide#applications> (26.01.2024)
6. AIR LIQUIDE. n.d. *Carbon Capture*. <https://engineering.airliquide.com/technologies/carbon-capture> (05.10.2023)
7. AIR SOURCE INDUSTRIES. 2023. *How Supercritical Carbon Dioxide Extraction is Used in Perfume Making*. <https://air-source.com/blog/how-supercritical-carbon-dioxide-extraction-is-used-in-perfume-making/> (10.01.2024)
8. AIRBUS. 2021a. *First A319neo flight with 100% sustainable aviation fuel*. Airbus. <https://www.airbus.com/en/newsroom/press-releases/2021-10-first-a319neo-flight-with-100-sustainable-aviation-fuel> (10.12.2023)
9. AIRBUS. 2021b. *Power-to-Liquids, explained*. Airbus. <https://www.airbus.com/en/newsroom/news/2021-07-power-to-liquids-explained> (10.12.2023)
10. AIRBUS. 2022. *Sustainable aviation fuels*. <https://www.airbus.com/en/innovation/energy-transition/sustainable-aviation-fuels> (10.12.2023)
11. AIRBUS. 2023a. *Airbus' most popular aircraft takes to the skies with 100% sustainable aviation fuel*. Airbus. <https://www.airbus.com/en/newsroom/stories/2023-03->

[airbus-most-popular-aircraft-takes-to-the-skies-with-100-sustainable](#) (10.12.2023)

12. AIRBUS. 2023b. *At Airbus, SAF-fuelled ferry flights are cleared for take off*. Airbus.

<https://www.airbus.com/en/newsroom/stories/2023-07-at-airbus-saf-fuelled-ferry-flights-are-cleared-for-take-off> (10.12.2023)

13. AKINDOYO, J. O., BEG, M. D. H., GHAZALI, S., ISLAM, M. R., JEYARATNAM, N., YUVARAJ, A. R. 2016. *Polyurethane types, synthesis and applications – a review*. RSC Advances, 6(115), 114453–114482.

<https://doi.org/10.1039/c6ra14525f>

14. ALAMI, A. H., HAWILI, A. A., HASSAN, R., AL-HEMYARI, M., AOKAL, K. 2019. *Experimental study of carbon dioxide as working fluid in a closed-loop compressed gas energy storage system*. Renewable Energy, 134, 603–611.

<https://doi.org/10.1016/j.renene.2018.11.046>

15. ALAMOOTI, A. M., MALEKABADI, F. K. 2018. *Chapter One - An Introduction to Enhanced Oil Recovery*. In *Fundamentals of Enhanced Oil and Gas Recovery from Conventional and Unconventional Reservoirs* (pp. 1–40). Amsterdam: Elsevier.

<http://dx.doi.org/10.1016/b978-0-12-813027-8.00001-1>

16. ALBRECHT, B. A. 2004. *Reactor Modeling and Process Analysis for Partial Oxidation of Natural Gas* [PhD Thesis, University of Twente].

<https://citeseerx.ist.psu.edu/document?repid=rep1&type=pdf&doi=b8815de74fa0fa75a1ea46dad1c129077e22ef40>

17. ALI, H., ELDRUP, N. H., NORMANN, F., SKAGESTAD, R., ØI, L. E. 2019. *Cost estimation of CO<sub>2</sub> absorption plants for CO<sub>2</sub> mitigation – method and assumptions*.

International Journal of Greenhouse Gas Control, 88, 10–23.

<https://doi.org/10.1016/j.ijggc.2019.05.028>

18. ALLIANCE CHEMICALS. 2021. *Product Data Sheet Monoethanolamine (MEA)*.

Amsterdam: Nouryon Chemicals Holding B.V. <https://www.alliancechemicals.com/wp-content/uploads/2019/01/MEA-Technical-Data-Sheet.pdf> (21.04.2023)

19. ALTUN, Z., BLEDA, E., TRINDLE, C. 2019. *Production of carbamic acid dimer from ammonia-carbon dioxide ices: Matching observed and computed IR spectra*. Life, 9(2).

<https://doi.org/10.3390/life9020034>

20. ALVARADO, V., MANRIQUE, E. 2010. *Enhanced oil recovery: An update review*. *Energies*, 3(9), 1529–1575. <https://doi.org/10.3390/en3091529>
21. APAIYAKUL, R., KANCHANAKUNGVALKUL, T., PUAPAN, P., NIMMANTERDWONG, P., LIU, H., GAO, H., LIANG, Z., TONTIWACHWUTHIKUL, P., SEMA, T. 2022a. *Absorption and Regeneration Performance of High Potential Second-Generation AMP-PZ-MEA Solvent for Carbon Capture*. Proceedings of the 16th Greenhouse Gas Control Technologies Conference (GHGT-16) 23-24 Oct 2022. [https://papers.ssrn.com/sol3/papers.cfm?abstract\\_id=4281523](https://papers.ssrn.com/sol3/papers.cfm?abstract_id=4281523)
22. APAIYAKUL, R., NIMMANTERDWONG, P., KANCHANAKUNGVALKUL, T., PUAPAN, P., GAO, H., LIANG, Z., TONTIWACHWUTHIKUL, P., SEMA, T. 2022b. *Precipitation behavior, density, viscosity, and CO<sub>2</sub> absorption capacity of highly concentrated ternary AMP-PZ-MEA solvents*. *International Journal of Greenhouse Gas Control*, 120, 103775. <https://doi.org/10.1016/j.ijggc.2022.103775>
23. APEKS SUPERCRITICAL. 2019. *Why Subcritical & Supercritical CO<sub>2</sub> Extraction*. <https://www.apekssupercritical.com/about/apeks-advantage/why-subcritical-supercritical-co2-extraction/> (15.12.2023)
24. ARACHCHIGE, U. S. P. 2019. *Carbon Dioxide Capture by Chemical Absorption: Energy Optimization and Analysis of Dynamic Viscosity of Solvents* [PhD Thesis, University of South-Eastern Norway]. <https://openarchive.usn.no/usn-xmlui/handle/11250/2583554>
25. ARAV, A. 2022. Cryopreservation by directional freezing and vitrification focusing on large tissues and organs. *Cells*, 11(7), 1072. <https://doi.org/10.3390/cells11071072>
26. ARGUS MEDIA. 2024. Low US natgas prices help ammonia economics. <https://www.argusmedia.com/en/news-and-insights/latest-market-news/2566315-low-us-natgas-prices-help-ammonia-economics>
27. ARNAUT, M., VULIN, D., LAMBERG, G. J. G., JUKIĆ, L. 2021. *Simulation analysis of CO<sub>2</sub>-EOR process and feasibility of CO<sub>2</sub> storage during EOR*. *Energies*, 14(4). <https://doi.org/10.3390/en14041154>
28. AROMADA, S. A., ELDRUP, N. H., NORMANN, F., ØI, L. E. 2021. *Simulation*

- and Cost Optimization of different Heat Exchangers for CO<sub>2</sub> Capture*. Linköping Electronic Conference Proceedings, 176, 318–325. <http://dx.doi.org/10.3384/ecp20176318>
29. ASPEN TECH SUPPORT CENTER. 2022. *Modeling of solids in Aspen HYSYS*. [https://esupport.aspentech.com/apex/s\\_search2?qry=Modeling%20of%20solids%20in%20Aspen%20HYSYS](https://esupport.aspentech.com/apex/s_search2?qry=Modeling%20of%20solids%20in%20Aspen%20HYSYS) (23.10.2022)
30. ASPEN TECHNOLOGY INC. 2007. *AspenTech Profile*. [https://web.archive.org/web/20070205182217/http://www.aspentech.com/corporate/press/mediakit/company\\_profile.pdf](https://web.archive.org/web/20070205182217/http://www.aspentech.com/corporate/press/mediakit/company_profile.pdf) (20.04.2024)
31. ASPEN TECHNOLOGY INC. 2008. *AspenTech Company History*. [https://web.archive.org/web/20080514172525/http://www.aspentech.com/corporate/index\\_history.cfm](https://web.archive.org/web/20080514172525/http://www.aspentech.com/corporate/index_history.cfm) (20.04.2024)
32. ASPEN TECHNOLOGY INC. 2023. *AspenTech: Over 40 years of innovation*. <https://www.aspentech.com/en/about-aspentech/history> (20.04.2024)
33. ASPEN TECHNOLOGY INC. 2022. *Acid Gas Cleaning – Efficiency vs. Advanced Modeling Calculation* [Aspen HYSYS V14 Help (software user manual)]. Bedford: Aspen Technology, Inc.
34. ATLAS COPCO. n.d. *What are commercial and industrial uses of carbon dioxide?* <https://www.atlascopco.com/en-us/compressors/wiki/compressed-air-articles/carbon-dioxide-uses> (20.12.2023)
35. AUDI. 2018. *Audi advances e-fuels technology: new “e-benzin” fuel being tested*. <https://www.audi-mediacycenter.com/en/press-releases/audi-advances-e-fuels-technologynew-e-benzin-fuel-being-tested-9912> (05.01.2024)
36. AUDI. 2023. *CEO Markus Duesmann: “China is getting on the sustainability train, and our model initiative is the perfect response”*. <https://www.audi-mediacycenter.com/en/press-releases/ceo-markus-duesmann-china-is-getting-on-the-sustainability-train-and-our-model-initiative-is-the-perfect-response-15315> (05.01.2024)
37. BABCOCK & WILCOX. 2024. *Flue Gas Treatment for Carbon Capture*. <https://www.babcock.com/home/environmental/emission-control/flue-gas-pre-treatment-for-post-combustion-carbon-capture/> (05.07.2024)



38. BAGHERANI, N., SMOLLER, B. R., TAVOOSIDANA, G., GHANADAN, A., WOLLINA, U., LOTTI, T. 2023. *An overview of the role of carboxytherapy in dermatology*. *Journal of Cosmetic Dermatology*, 22(9), 2399–2407. <https://doi.org/10.1111/jocd.15741>
39. BAGNATO, G., SANNA, A. 2018. *Chapter 15 - Membrane Considerations and Plant Design for Pre-Combustion CO<sub>2</sub> Capture*. In *Current Trends and Future Developments on (Bio-) Membranes* (pp. 415–435). Amsterdam: Elsevier. <https://doi.org/10.1016/B978-0-12-813645-4.00015-5>
40. BAHRAMI, M. 2015. *Chemical reactions*. <https://www.sfu.ca/~mbahrami/ENSC%20461/Notes/Chemical%20Reactions.pdf> (16.03.2024)
41. BALLAMINE, A., KOTNI, A., LLORED, J.-P., CAILLOL, S. 2022. *Valuing CO<sub>2</sub> in the development of polymer materials*. *Science and Technology for Energy Transition*, 77, 1. <https://doi.org/10.2516/stet/2021001>
42. BALTICSHIPPING.COM. 2024. <https://www.balticshipping.com/vessel/imo/9256767> (16.08.2024)
43. BANDILLA, K. W. 2020. *31 - Carbon capture and storage*. In *Future Energy* (pp. 669–692). Amsterdam: Elsevier. <http://dx.doi.org/10.1016/b978-0-08-102886-5.00031-1>
44. BARANOVIĆ, L. 2020. *Ion exchangers and their application in water demineralization* [Bachelor thesis, Division of Chemistry, Faculty of Chemistry and Technology, University of Split]. <https://urn.nsk.hr/urn:nbn:hr:167:121482>
45. BAUKAL, C. E., Jr. 2013. *Oxygen-Enhanced Combustion*. CRC Press. <https://doi.org/10.1201/b13974>
46. BELLONA. 2022. *Rail and Ship Transport of CO<sub>2</sub> to Storage: Key to Enable Slovenian Industrial Decarbonisation at Salonit Anhavo Cement Plant* [Interview]. <https://bellona.org/news/eu/2022-06-rail-and-ship-transport-of-co2-to-storage-key-to-enable-slovenian-industrial-decarbonisation-at-salonit-anhavo-cement-plant> (16.08.2023)
47. BENJAMINSEN, C. 2019. *This is what you need to know about CCS – Carbon Capture and Storage*. SINTEF. <https://www.sintef.no/en/latest-news/2019/this-is-what-you-need-to-know-about-ccs-carbon-capture-and-storage/> (16.11.2022)
48. BETTENHAUSEN, C. 2022. *US faces CO<sub>2</sub> shortage*. *American Chemical Society*.

<https://cen.acs.org/materials/US-faces-CO-shortage/100/i29> (20.08.2024)

49. BHATTACHARYA, SANKHA. 2018. *Cryoprotectants and their usage in cryopreservation process*. IntechOpen. <https://www.intechopen.com/chapters/64165>
50. BHATTACHARYA, SOUMYADEEP. 2021. *Kinetic study of CO<sub>2</sub> absorption in aqueous amine solutions of MEA-AMP: experiment and numerical modeling* [Master thesis, Faculty of Graduate Studies and Research, University of Regina]. <https://ourspace.uregina.ca/items/9ecd2929-65f6-41a3-b588-528d9278e420>
51. BLAGEC, T. 2023. *Uklanjanje CO<sub>2</sub> iz otpadnih plinova procesom adsorpcije s promjenom tlaka* [Master thesis, Faculty of Chemical Engineering and Technology]. <https://repozitorij.fkit.unizg.hr/islandora/object/fkit%3A2419>
52. BOC LIMITED. n.d. *Purity, Grades and Concentration*. <https://www.boconline.co.uk/en/contact-and-support/technical-advice/speciality-products-advice/purity-grades-concentration/purity-grades.html> (21.05.2023)
53. BOHONĚK, M. 2012. *Cryopreservation of blood*. In *Blood Transfusion in Clinical Practice*. London: InTech. <http://dx.doi.org/10.5772/36146>
54. BOND, S. 2024. *Ship Design for CO<sub>2</sub> Transportation*. <https://wwwcdn.imo.org/localresources/en/About/Events/Documents/Science%20Day%20Symposium%202024/5.%20ABS%20Europe%20Sean%20Bond%20Science%20Day%202024%20MS.pdf> (21.08.2024)
55. BREZOVAC, I. 2021. *Definiranje dubokog slanog vodonosnika Osijek u Osječkim pješčenjacima istočnog dijela Dravske depresije i procjena perspektivnosti za geološko skladištenje ugljičnog dioksida* [Master thesis, Faculty of Mining, Geology and Petroleum Engineering, University of Zagreb]. <https://urn.nsk.hr/urn:nbn:hr:169:227892>
56. BRKIĆ, V. 2020. *Gas lift, Oil and Gas Production 2 course material*. Zagreb: Faculty of Mining, Geology and Petroleum Engineering, University of Zagreb
57. BROGAN, R. J. 2011. *SHELL AND TUBE HEAT EXCHANGERS*. <https://www.thermopedia.com/content/1121/> (21.06.2023)
58. BROWNSORT, D. P. A. 2019. *Briefing on carbon dioxide specifications for transport - 1st Report of the Thematic Working Group on: CO<sub>2</sub> transport, storage and*

[https://www.ccusnetwork.eu/sites/default/files/TG3\\_Briefing-CO2-Specifications-for-Transport.pdf](https://www.ccusnetwork.eu/sites/default/files/TG3_Briefing-CO2-Specifications-for-Transport.pdf)

59. BRYNOLF, S., TALJEGARD, M., GRAHN, M., HANSSON, J. 2018. Electrofuels for the transport sector: A review of production costs. *Renewable and Sustainable Energy Reviews*, 81, 1887–1905. <https://doi.org/10.1016/j.rser.2017.05.288>
60. BUDIŠA, M., BURELA, S., VASILJEVIĆ, R., ŠEPAROVIĆ, M., MIKULIĆ, K., MIHALJINEC, M., KONČURAT, L. 2013. *Tehničko - tehnološko rješenje postojećeg postrojenja INA - industrija nafte d.d. Rafinerija nafte Rijeka*. Zagreb: ECOINA d.o.o. [https://mingo.gov.hr/UserDocsImages/NASLOVNE%20FOTOGRAFIJE%20I%20KORI%20C5%A0TENI%20LOGOTIPOVI/doc/tehnicko-tehnolosko\\_rjesenje\\_21.pdf](https://mingo.gov.hr/UserDocsImages/NASLOVNE%20FOTOGRAFIJE%20I%20KORI%20C5%A0TENI%20LOGOTIPOVI/doc/tehnicko-tehnolosko_rjesenje_21.pdf) (20.06.2023)
61. BUSINESS ANALYTIQ. 2024. *Monoethanolamine price index*. <https://businessanalytiq.com/procurementanalytics/index/monoethanolamine-price-index/> (15.08.2024)
62. BUTTERWORTH, P. 2023. *Carbon capture economics: Why \$200 /tCO<sub>2</sub> is the crucial figure*. CRU Group. <https://sustainability.crugroup.com/article/carbon-capture-economics-why-usd-200-per-tco2-is-the-crucial-figure> (15.04.2023)
63. CALIFORNIA AIR RESOURCES BOARD. n.d. *Cap-and-Trade Program*. <https://ww2.arb.ca.gov/our-work/programs/cap-and-trade-program> (15.04.2023)
64. CAPUZZO, A., MAFFEI, M., OCCHIPINTI, A. 2013. *Supercritical fluid extraction of plant flavors and fragrances*. *Molecules*, 18(6), 7194–7238. <https://doi.org/10.3390/molecules18067194>
65. CATF. 2023a. *Europe CCS Cost Tool*. <https://www.catf.us/ccs-cost-tool/> (18.12.2023)
66. CATF. 2023b. *The cost of carbon capture and storage in Europe*. Clean Air Task Force. <https://www.catf.us/ccs-cost-tool/> (19.12.2023)
67. CCSNORWAY.COM. 2022. *Developing Longship – Key lessons learned - Experiences from the Norwegian Full-scale CCS Demonstration project*. In *Fullskala*. Porsgrunn: Gassnova SF. <https://ccsnorway.com/publication/developing-longship-key->

[lessons-learned/](#) (19.12.2023)

68. CECELSKI, C. E., HARRIS, K. J., GOODMAN, C. A., KIMES, W. A., LIU, Q., MILLER, W. R., CARNEY, J. 2022. *Certification of NIST gas mixture Standard Reference Materials*. National Institute of Standards and Technology (U.S.). <http://dx.doi.org/10.6028/nist.sp.260-222>
69. CHAI, S. Y. W., NGU, L. H., HOW, B. S. 2022. *Review of carbon capture absorbents for CO<sub>2</sub> utilization*. *Greenhouse Gases: Science and Technology*, 12(3), 394–427. <https://doi.org/10.1002/ghg.2151>
70. CHEMENGGUY. n.d.-a. *Aspen Plus vs. HYSYS? What's the difference?* – *ChemEngGuy*. <https://chemicalengineeringguy.com/the-blog/process-simulation/aspen-plus-vs-hysys-whats-the-difference/> (19.10.2022)
71. CHEMENGGUY. n.d.-b. *This is WHY I like HYSYS!* <https://chemicalengineeringguy.com/the-blog/process-simulation/this-is-why-i-like-hysys/>
72. CHEMENGONLINE.COM. n.d. *The Chemical Engineering Plant Cost Index* ®. <https://www.chemengonline.com/pci-home> (19.10.2022)
73. CHEMEUROPE.COM. 2024. *Reflux*. <https://www.chemeurope.com/en/encyclopedia/Reflux.html> (19.06.2024)
74. CHEN, J., LIU, X., HU, Y., CHEN, X., TAN, S. 2023. *Cryopreservation of tissues and organs: Present, bottlenecks, and future*. *Frontiers in Veterinary Science*, 10. <https://doi.org/10.3389/fvets.2023.1201794>
75. CHEN, Z. 2022. *A review of pre-combustion carbon capture technology*. *Advances in Economics, Business and Management Research*. <http://dx.doi.org/10.2991/aebmr.k.220405.086>
76. CHILDREN'S HOSPITAL OF PHILADELPHIA. n.d. *Traveling with breast milk*. <https://www.chop.edu/pages/traveling-breast-milk> (27.12.2023)
77. CHIRCOP, D., FORMOSA, C. 2015. *Comparación de la eficacia de dos técnicas de crioterapia para el tratamiento de las verrugas plantares*. *Revista Internacional de Ciencias Podológicas*, 9(1), 44–49. [https://doi.org/10.5209/rev\\_RICP.2015.v9.n1.47316](https://doi.org/10.5209/rev_RICP.2015.v9.n1.47316)
78. CHOWDHURY, F. A., OKABE, H., SHIMIZU, S., ONODA, M., FUJIOKA, Y.

2009. *Development of novel tertiary amine absorbents for CO<sub>2</sub> capture*. Energy Procedia, 1(1), 1241–1248. <https://doi.org/10.1016/j.egypro.2009.01.163>
79. CIGULA, L. 2018. *Desalinacija morske vode napajana fotonaponskim sustavima*. Faculty of Geotechnical Engineering, University of Zagreb. <https://urn.nsk.hr/urn:nbn:hr:130:097898>
80. CLEAN AIR TASK FORCE [CATF]. 2023. *Mapping the cost of carbon capture and storage in Europe*. <https://www.catf.us/2023/02/mapping-cost-carbon-capture-storage-europe/> (19.12.2023)
81. CO2METER. 2024. *Carbon Dioxide (CO<sub>2</sub>) Purity Grade Chart*. <https://www.co2meter.com/blogs/news/co2-purity-grade-charts> (19.12.2023)
82. CORNWALL, W. 2023. *How to deep freeze an entire organ—and bring it back to life*. American Association for the Advancement of Science (AAAS). <https://www.science.org/content/article/how-to-deep-freeze-entire-organ-bring-it-back-to-life> (19.11.2023)
83. COSTA, J. 2021. *WHAT IS THE DIFFERENCES BETWEEN ASPEN HYSYS and ASPEN PLUS? – JEFERSON COSTA*. <https://jefersoncosta.com/what-is-the-differences-between-aspen-hysys-and-aspen-plus/> (25.11.2022)
84. CRNOBRNJA, B. 2008. *Projekt uređaja za desalinizaciju bočate vode reverznom osmozom* [Master thesis, Faculty of Mechanical Engineering and Naval Architecture, University of Zagreb]. <https://urn.nsk.hr/urn:nbn:hr:235:414240>
85. CVRILA, I. n.d. *e-škola: kemija*. <http://eskola.chem.pmf.hr/odgovori/odgovor.php3?sif=15457> (26.01.2024)
86. ČAUŠEVIĆ POKAS, J. 2018. *Application of ion exchange in water preparation* [Bachelor thesis, Faculty of Metallurgy, University of Zagreb]. <https://urn.nsk.hr/urn:nbn:hr:115:411920>
87. ČULINA, M. 2016. *Protupožarna zaštita zaštićenih područja na primjeru Nacionalnog parka “Krka”* [Bachelor thesis, Karlovac University of Applied Sciences]. <https://repozitorij.vuka.hr/islandora/object/vuka:597>
88. ČATIĆ, A. 2021. *Pregled CCUS projekata u naftnoj industriji* [Master thesis,

Faculty of Mining, Geology and Petroleum Engineering, University of Zagreb].  
<https://repozitorij.rgn.unizg.hr/en/islandora/object/rgn%3A1924>

89. DA ROSA, A. V., ORDÓÑEZ, J. C. 2022. *Chapter 10 - Hydrogen production*. In *Fundamentals of Renewable Energy Processes* (pp. 419–470). Amsterdam: Elsevier.  
<http://dx.doi.org/10.1016/b978-0-12-816036-7.00021-x>

90. DE RIVA, J., SUAREZ-REYES, J., MORENO, D., DÍAZ, I., FERRO, V., PALOMAR, J. 2017. *Ionic liquids for post-combustion CO<sub>2</sub> capture by physical absorption: Thermodynamic, kinetic and process analysis*. *International Journal of Greenhouse Gas Control*, 61, 61–70. <https://doi.org/10.1016/j.ijggc.2017.03.019>

91. DE VRIES, R. J., TESSIER, S. N., BANIK, P. D., NAGPAL, S., CRONIN, S. E. J., OZER, S., HAFIZ, E. O. A., VAN GULIK, T. M., YARMUSH, M. L., MARKMANN, J. F., TONER, M., YEH, H., UYGUN, K. 2019. *Supercooling extends preservation time of human livers*. *Nature Biotechnology*, 37(10), 1131–1136. <https://doi.org/10.1038/s41587-019-0223-y>

92. DE ZEEUW, H.-J. 2024. *Drastic changes ahead for the nitrogen fertilizer industry in the EU*. Rabobank. <https://www.rabobank.com/knowledge/d011411121-drastic-changes-ahead-for-the-nitrogen-fertilizer-industry-in-the-eu> (17.08.2024)

93. DEJANOVIĆ, I. 2023. Electronic mail with prof. Igor Dejanović, 31<sup>st</sup> August 2023.

94. DEMIROVIĆ, F. 2016. *Sustav za odabir optimalne EOR metode* [Master thesis, Faculty of Mining, Geology and Petroleum Engineering, University of Zagreb].  
<https://repozitorij.rgn.unizg.hr/islandora/object/rgn:486>

95. DESPORT, L., SELOSSE, S. 2022. *Perspectives of CO<sub>2</sub> utilization as a negative emission technology*. *Sustainable Energy Technologies and Assessments*, 53, 102623.  
<https://doi.org/10.1016/j.seta.2022.102623>

96. DEVČIĆ, I. 2022. *Metode desalinizacije* [Bachelor thesis, Faculty of Mining, Geology and Petroleum Engineering, University of Zagreb].  
<https://urn.nsk.hr/urn:nbn:hr:169:339419>

97. DIERINGER, P., MARX, F., ALOBAID, F., STRÖHLE, J., EPPLÉ, B. 2020. *Process control strategies in chemical looping gasification—a novel process for the*

- production of biofuels allowing for net negative CO2 emissions*. Applied Sciences, 10(12). <https://doi.org/10.3390/app10124271>
98. DIESCHWEISSPROFIS.DE. 2024. *CO2 Flasche 10 kg - Füllung im Tausch*. <https://www.dieschweissprofis.de/gase-zubehoer/co2-kohlensaure/6005/co2-flasche-10-kg-fuellung-im-tausch?number=TGF6014> (10.08.2024)
99. DILSHAD, S., KALAIR, A. R., KHAN, N. 2019. *Review of carbon dioxide (CO2) based heating and cooling technologies: Past, present, and future outlook*. International Journal of Energy Research, 44(3), 1408–1463. <https://doi.org/10.1002/er.5024>
100. DM.DE. 2024. *CO2-Zylinder Bei Dm Tauschen*. <https://www.dm.de/services/services-im-markt/co2-zylinder-tauschen-158374> (10.08.2024)
101. DONALDSON, E. C., CHILINGARIAN, G. V., YEN, T. F., SHARMA, M. K. 1989. *Chapter 1 Introduction*. In *Developments in Petroleum Science* (pp. 1–11). Amsterdam: Elsevier. [http://dx.doi.org/10.1016/s0376-7361\(08\)70453-9](http://dx.doi.org/10.1016/s0376-7361(08)70453-9)
102. DRAGOBRA TOVIĆ, A., HOLEND A, K. 2018. *Zasićeni ugljikovodici – alkani – Kemija 8*. <https://edutorij-admin-api.carnet.hr/storage/extracted/7b5e1fe5-86e2-4142-af6c-5197c4a08148/kemija-8/m03/j02/index.html> (10.02.2024)
103. DROGOVOZ, S., TSUVUNIN, V., LAZORENKO, S., KALYNYCHENKO, I., LATINA, H., KALKO, K. 2021. *CARBOXYTHERAPY AS DOPING IN ATHLETES*. *PharmacologyOnLine Archives*, 3, 1824–1830.
104. DULEY, W. 1976. *CO2 lasers effects and applications*. Amsterdam: Elsevier.
105. DUTCH EMISSIONS AUTHORITY. 2023a. *Surrendering allowances*. <https://www.emissionsauthority.nl/topics/year-end-closing-ets/surrendering-allowances> (10.01.2024)
106. DUTCH EMISSIONS AUTHORITY. 2023b. *Transactions*. <https://www.emissionsauthority.nl/topics/eu-ets-registry-2021-2030/transactions> (10.01.2024)
107. DUTCH EMISSIONS AUTHORITY. 2023c. *What is emissions trading?* <https://web.archive.org/web/20230323004801/https://www.emissionsauthority.nl/topics/what-is-emissions-trading> (10.01.2024)

108. DUVAL, S. 2023. *Chapter 2 - Natural gas sweetening*. In *Surface Process, Transportation, and Storage* (pp. 37–78). Amsterdam: Elsevier. <http://dx.doi.org/10.1016/b978-0-12-823891-2.00007-7>
109. DŽEKO, A. 2009. *Analiza varijanti osiguranja pitke vode koristeći LCA metodologiju na primjeru otoka Lastova* [Master thesis, Faculty of Mechanical Engineering and Naval Architecture, University of Zagreb]. <https://urn.nsk.hr/urn:nbn:hr:235:332123>
110. EEX. 2023. *EU ETS – Participation in the auctions and outlook secondary market*. [https://web.archive.org/web/20230811014119/https://www.eex.com/fileadmin/Global/Webinar/20230607\\_EU\\_ETS -  
Auction participation and Secondary Market Outlook EEX.pdf](https://web.archive.org/web/20230811014119/https://www.eex.com/fileadmin/Global/Webinar/20230607_EU_ETS_-_Auction_participation_and_Secondary_Market_Outlook_EEX.pdf) (10.01.2023)
111. ELECTREK. 2022. *The world's first CO2 battery for long-duration energy storage is headed to the US*. <https://electrek.co/2022/11/14/the-worlds-first-co2-battery-for-long-duration-energy-storage-is-headed-to-the-us/> (10.01.2023)
112. ELECTREK. 2023. *German automakers take different sides on the use of e-fuels over EVs*. <https://electrek.co/2023/04/28/german-automakers-take-different-sides-on-e-fuel-use-over-evs/> (10.12.2024)
113. ELECTRIC POWER RESEARCH INSTITUTE. 2002. *CO2 Blast Cleaning Process*. Palo Alto: Electric Power Research Institute. <https://www.epri.com/research/products/000000000001006617> (10.10.2023)
114. ELLIOTT, D. C. 2004. *Biomass, chemicals from*. In *Encyclopedia of Energy* (pp. 163–174). Amsterdam: Elsevier. <https://doi.org/10.1016/B0-12-176480-X/00358-2>
115. EMBER-CLIMATE.ORG. 2024. *Electricity and carbon prices*. <https://ember-climate.org/data/data-tools/european-electricity-prices-and-costs/> (28.08.2024)
116. EMERSON.COM. 2024. *Level measurement solutions for distillation column reflux drums*. <https://www.emerson.com/en-gb/automation/measurement-instrumentation/common-applications/level-measurement-for-distillation-column-reflux-drums> (28.04.2024)
117. ENCYCLOPAEDIA BRITANNICA. 2019. *Urea-formaldehyde resin*. <https://www.britannica.com/science/urea-formaldehyde-resin> (12.12.2023)



118. ENCYCLOPAEDIA BRITANNICA. 2024a. *Adsorption*. <https://www.britannica.com/science/adsorption> (29.12.2023)
119. ENCYCLOPAEDIA BRITANNICA. 2024b. *Dry ice*. <https://www.britannica.com/technology/dry-ice> (28.12.2023)
120. ENERGY DOME. 2024. *CO2 battery*. <https://energydome.com/co2-battery/> (10.01.2024)
121. ENERQUIP. 2018. *7 shell configurations to consider when designing a shell and tube heat exchanger*. <https://www.enerquip.com/7-shell-configurations-what-you-need-to-know-when-designing-a-shell-and-tube-heat-exchanger/> (28.04.2023)
122. ENERQUIP. 2024. *Difference Between Parallel Flow, Counter Flow, and Crossflow Heat Exchangers*. <https://www.enerquip.com/whats-the-difference-between-parallel-flow-counter-flow-and-crossflow-heat-exchangers/> (01.05.2023)
123. ENGGCYCLOPEDIA.COM. 2023. *Kettle reboilers*. EnggCyclopedia. <https://enggcyclopedia.com/2023/02/kettle-reboilers/> (01.05.2023)
124. ENI, SNAM. 2024. *Ravenna CCS*. <https://ravennaccs.com/en-IT/home> (14.02.2023)
125. EPA. 2016. *Monitoring by Control Technique - Electrostatic Precipitators*. <https://www.epa.gov/air-emissions-monitoring-knowledge-base/monitoring-control-technique-electrostatic-precipitators> (05.10.2022)
126. EUROPEAN CENTRAL BANK. 2024. *Swiss franc (CHF)*. [https://www.ecb.europa.eu/stats/policy\\_and\\_exchange\\_rates/euro\\_reference\\_exchange\\_rates/html/eurofxref-graph-chf.en.html](https://www.ecb.europa.eu/stats/policy_and_exchange_rates/euro_reference_exchange_rates/html/eurofxref-graph-chf.en.html) (30.08.2024)
127. EUROPEAN CHEMICALS AGENCY. 2014. *Regulation (EU) n°528/2012 concerning the making available on the market and use of biocidal products - Evaluation of active substances - Competent Authority Report - Carbon dioxide*.
128. EUROPEAN COMMISSION. 2019. *Upute br. 8 za usklađenu metodologiju besplatne dodjele emisijskih jedinica za razdoblje EU ETS-a nakon 2020. godine - Otpadni plinovi i potpostrojenje s procesnim emisijama*. [https://mingo.gov.hr/UserDocsImages/klimatske\\_aktivnosti/emisijske\\_jedinice/upute\\_dodjela\\_emisijskih\\_jedinica/gd8\\_up\\_otp\\_plin\\_pot\\_emis.pdf](https://mingo.gov.hr/UserDocsImages/klimatske_aktivnosti/emisijske_jedinice/upute_dodjela_emisijskih_jedinica/gd8_up_otp_plin_pot_emis.pdf)

(30.07.2024)

129. EUROPEAN COMMISSION. 2020a. *European Energy Exchange appointed as EU ETS common auction platform from 2021*. [https://climate.ec.europa.eu/news-your-voice/news/european-energy-exchange-appointed-eu-ets-common-auction-platform-2021-2020-11-09\\_en](https://climate.ec.europa.eu/news-your-voice/news/european-energy-exchange-appointed-eu-ets-common-auction-platform-2021-2020-11-09_en) (29.02.2024)
130. EUROPEAN COMMISSION. 2020b. *List of appointed Auctioneers*. [https://climate.ec.europa.eu/system/files/2020-10/list\\_of\\_auctioneers\\_en.pdf](https://climate.ec.europa.eu/system/files/2020-10/list_of_auctioneers_en.pdf) (29.10.2023)
131. EUROPEAN COMMISSION. 2021a. *Auctioning*. [https://climate.ec.europa.eu/eu-action/eu-emissions-trading-system-eu-ets/auctioning\\_en](https://climate.ec.europa.eu/eu-action/eu-emissions-trading-system-eu-ets/auctioning_en) (29.10.2023)
132. EUROPEAN COMMISSION. 2021b. *Questions and Answers - Emissions Trading – Putting a Price on carbon*. European Commission. [https://ec.europa.eu/commission/presscorner/detail/en/qanda\\_21\\_3542](https://ec.europa.eu/commission/presscorner/detail/en/qanda_21_3542) (29.10.2023)
133. EUROPEAN COMMISSION. 2023. *Auctions by the Common Auction Platform April, May, June 2023*. [https://climate.ec.europa.eu/document/download/12cff3db-19fe-41a1-9da6-1103f93f2410\\_en?filename=cap\\_report\\_202306\\_en.pdf](https://climate.ec.europa.eu/document/download/12cff3db-19fe-41a1-9da6-1103f93f2410_en?filename=cap_report_202306_en.pdf) (29.10.2023)
134. EUROPEAN COMMISSION. 2024a. *Conversion of CO<sub>2</sub>/H<sub>2</sub>O to Polyethylene through Cascade Electro-reduction–Polymerisation Catalysis*. <https://cordis.europa.eu/project/id/892003> (10.08.2024)
135. EUROPEAN COMMISSION. 2024b. *European Union Transaction Log*. <https://ec.europa.eu/clima/ets/oha.do> (10.03.2024)
136. EUROPEAN COMMISSION. n.d. *What is the EU ETS?*. [https://climate.ec.europa.eu/eu-action/eu-emissions-trading-system-eu-ets/what-eu-ets\\_en](https://climate.ec.europa.eu/eu-action/eu-emissions-trading-system-eu-ets/what-eu-ets_en) (10.10.2023)
137. EUROPEAN COMMITTEE FOR STANDARDIZATION. 2022. CEN/TR 15281:2022. Potentially explosive atmospheres - Explosion prevention and protection - Guidance on inerting for the prevention of explosions. Bruxelles: CEN
138. EUROPEAN ENERGY EXCHANGE [EEX]. 2024. *EU ETS auctions*. <https://www.eex.com/en/markets/environmental-markets/eu-ets-auctions> (10.03.2024)
139. EVANS, L. B., BOSTON, J. F., BRITT, H. I., GALLIER, P. W., GUPTA, P. K.,

- JOSEPH, B., MAHALEC, V., NG, E., SEIDER, W. D., YAGI, H. 1979. ASPEN: *An advanced system for process engineering*. Computers & Chemical Engineering, 3(1–4), 319–327. [https://doi.org/10.1016/0098-1354\(79\)80053-8](https://doi.org/10.1016/0098-1354(79)80053-8)
140. FAISAL ELMOBARAK, W., ALMOMANI, F., TAWALBEH, M., AL-OTHMAN, A., MARTIS, R., RASOOL, K. 2023. *Current status of CO<sub>2</sub> capture with ionic liquids: Development and progress*. Fuel, 344, 128102. <https://doi.org/10.1016/j.fuel.2023.128102>
141. FARAJZADEH, R., EFTEKHARI, A. A., DAFNOMILIS, G., LAKE, L. W., BRUINING, J. 2020. *On the sustainability of CO<sub>2</sub> storage through CO<sub>2</sub> – Enhanced oil recovery*. Applied Energy, 261, 114467. <https://doi.org/10.1016/j.apenergy.2019.114467>
142. FERTILIZERS EUROPE. 2024. *Beyond Gas. The Risks of Fertilizer Dependence for EU*. <https://www.fertilizerseurope.com/beyond-gas-the-risks-of-fertilizer-dependence-for-eu/> (17.08.2024)
143. FISHER, K. S., BEITLER, C., RUETER, C., SEARCY, K., ROCHELLE, G., JASSIM, M. 2005. *Integrating MEA regeneration with CO<sub>2</sub> compression and peaking to reduce CO<sub>2</sub> capture costs*. <https://www.osti.gov/biblio/842857>
144. FISHER, K. S., SEARCY, K., ROCHELLE, G. T., ZIAII, S., SCHUBERT, C. 2007. *Advanced amine solvent formulations and process integration for near-term CO<sub>2</sub> capture success*. OSTI.GOV. <https://www.osti.gov/biblio/945367>
145. FLOROS, J. D., MATSOS, K. I. 2005. *Introduction to modified atmosphere packaging*. In *Innovations in Food Packaging* (pp. 159–172). Amsterdam: Elsevier. <http://dx.doi.org/10.1016/b978-012311632-1/50042-5>
146. FONDER, M., COUNOTTE, P., DACHET, V., DE SÉJOURNET, J., ERNST, D. 2024. *Synthetic methane for closing the carbon loop: Comparative study of three carbon sources for remote carbon-neutral fuel synthetization*. Applied Energy, 358, 122606. <https://doi.org/10.1016/j.apenergy.2023.122606>
147. FRAIJ, H. A. 2023. *Evaluating and Optimizing the Performance of Single and Blended Amines Based on their Chemical Structures for Carbon Dioxide Capture from Industrial Gas Streams* [PhD Thesis, Faculty of Graduate Studies and Research, University of Regina]. <https://www.proquest.com/docview/2890694606>

148. FRANCHI, G., CAPOCELLI, M., DE FALCO, M., PIEMONTE, V., BARBA, D. 2020. *Hydrogen production via steam reforming: A critical analysis of MR and RMM technologies*. *Membranes*, 10(1), 10. <https://doi.org/10.3390/membranes10010010>
149. FRANKI, V., VIŠKOVIĆ, A., ŠAPIĆ, A. 2019. *Carbon capture and storage retrofit: Case study for Croatia*. *Energy Sources, Part A: Recovery, Utilization, and Environmental Effects*, 43(24), 3238–3250. <https://doi.org/10.1080/15567036.2019.1587077>
150. GALÈS, A., TRIPLET, S., GEOFFROY, T., ROQUES, C., CARRÉ, C., LE FLOC'H, E., LANFRANCHI, M., SIMIER, M., ROQUE D'ORBCASTEL, E., PRZYBYLA, C., FOUILLAND, E. 2020. *Control of the pH for marine microalgae polycultures: A key point for CO<sub>2</sub> fixation improvement in intensive cultures*. *Journal of CO<sub>2</sub> Utilization*, 38, 187–193. <https://doi.org/10.1016/j.jcou.2020.01.019>
151. GAO, H., HUANG, Y., ZHANG, X., BAIRQ, Z. A. S., HUANG, Y., TONTIWACHWUTHIKUL, P., LIANG, Z. 2020. *Catalytic performance and mechanism of SO<sub>4</sub><sup>2-</sup>/ZrO<sub>2</sub>/SBA-15 catalyst for CO<sub>2</sub> desorption in CO<sub>2</sub>-loaded monoethanolamine solution*. *Applied Energy*, 259, 114179. <https://doi.org/10.1016/j.apenergy.2019.114179>
152. GASWORLD. 2021. *CO<sub>2</sub>: Fertiliser plant closures confirmed, more expected*. <https://www.gasworld.com/story/co2-fertiliser-plant-closures-confirmed-more-expected/2092559.article/> (25.08.2023)
153. GASWORLD. 2022a. 2022: *The most challenging year for CO<sub>2</sub> supply*. <https://www.gasworld.com/feature/2022-the-most-challenging-year-for-co2-supply/2118799.article/> (25.08.2023)
154. GASWORLD. 2022b. *UK CO<sub>2</sub> shortage concerns erupt as Billingham halts ammonia production*. <https://www.gasworld.com/story/uk-co2-shortage-concerns-erupt-as-billingham-halts-ammonia-production/> (25.08.2023)
155. GASWORLD. 2022c. *US CO<sub>2</sub> shortage: Benzine and its impact on the US CO<sub>2</sub> market*. <https://www.gasworld.com/story/us-co2-shortage-benzine-and-its-impact-on-the-us-co2-market/2094527.article/> (25.08.2023)
156. GASWORLD. 2022d. *US CO<sub>2</sub> shortage: Strains set to continue throughout the*

- coming months. <https://www.gasworld.com/story/us-co2-shortage-strains-set-to-continue-throughout-the-coming-months/2094525.article/> (25.08.2023)
157. GASWORLD. 2023. *US CO2 shortage: One year on.* <https://www.gasworld.com/story/us-co2-shortage-one-year-on/2126236.article/> (25.08.2023)
158. GASWORLD. 2024a. *2024 US merchant CO2 report.* <https://www.gasworld.com/feature/2024-us-merchant-co2-report/2136587.article/> (25.08.2024)
159. GASWORLD. 2024b. *CCU more an opportunity than storage, says Nippon Gases Director.* <https://www.gasworld.com/story/ccu-more-an-opportunity-than-storage-says-nippon-gases-director/2135938.article/> (25.08.2024)
160. GASWORLD. 2024c. *CO2 Solutions Coalition wants a shake-up of CO2 policy in the US.* <https://www.gasworld.com/feature/co2-solutions-coalition-wants-a-shake-up-of-co2-policy-in-the-us/2136555.article/> (25.08.2024)
161. GASWORLD. 2024d. *Distributors “still facing CO2 challenges” – Meritus.* <https://www.gasworld.com/story/distributors-still-facing-co2-challenges-meritus/2140295.article/> (25.08.2024)
162. GASWORLD. 2024e. *Embracing a new era in CO2.* Gasworld. <https://www.gasworld.com/story/embracing-a-new-era-in-co2/2142043.article/> (25.08.2024)
163. GASWORLD. 2024f. *European CO2 Summit.* <https://www.gasworldconferences.com/conference/european-co2-summit-2024/> (25.08.2024)
164. GASWORLD. 2024g. *European CO2 Summit 2024, day one.* <https://www.gasworld.com/story/european-co2-summit-2024-day-one/2134497.article/> (25.08.2024)
165. GASWORLD. 2024h. *European CO2 Summit 2024: Preview.* <https://www.gasworld.com/feature/european-co2-summit-2024-preview/2132752.article/> (25.08.2024)

166. GASWORLD. 2024i. *The 1895 Podcast - Episode XX*. <https://www.gasworld.com/the-1895-podcast/> (25.08.2024)
167. GASWORLD. 2024j. *Virginia plant shutdown could be 'massive' for CO<sub>2</sub> market*. <https://www.gasworld.com/story/virginia-plant-shutdown-could-be-massive-for-co2-market/2142084.article/> (25.08.2024)
168. GASWORLD. 2024k. *We haven't weathered the CO<sub>2</sub> storm, says Carson*. <https://www.gasworld.com/feature/we-havent-weathered-the-co2-storm-says-carson/2134931.article/> (25.08.2024)
169. GASWORLD. 2024l. *Investment builds in CCUS and hydrogen*. <https://www.gasworld.com/story/investment-builds-in-ccus-and-hydrogen/2139794.article/> (25.08.2024)
170. GIBIOMED. 2016. *ORGANS Capsules for transplants*. <https://gibiomed.com/wp-content/uploads/2016/09/GIBIOMED-Organs.pdf> (25.11.2023)
171. GLOBAL CCS INSTITUTE. 2021. *Global Status of CCS 2021*. Docklands: Global CCS Institute. <https://www.globalccsinstitute.com/resources/publications-reports-research/global-status-of-ccs-2021/> (23.11.2023)
172. GOOGLE PATENTS. 1978. *Urea derivative and use as polyurethane catalyst*. <https://patents.google.com/patent/US4194069A/en> (15.01.2024)
173. GOOGLE PATENTS. 1979. *Urea derivatives and use as polyurethane catalysts*. <https://patents.google.com/patent/US4242467A/en> (15.01.2024)
174. GOOGLE PATENTS. 2001. *Catalytic partial oxidation process using staged oxygen addition*. <https://patents.google.com/patent/WO2001051412A1/en> (15.01.2024)
175. GOOGLE PATENTS. 2005. *PECVD processes for silicon dioxide films*. <https://patents.google.com/patent/US20070054505A1/en> (15.01.2024)
176. GOOGLE PATENTS. 2006. *Removal of CO<sub>2</sub> from flue gas*. <https://patents.google.com/patent/GB2434330A/en> (15.01.2024)
177. GOOS, E., RIEDEL, U., ZHAO, L., BLUM, L. 2011. *Phase diagrams of CO<sub>2</sub> and CO<sub>2</sub>-N<sub>2</sub> gas mixtures and their application in compression processes*. Energy Procedia, 4, 3778–3785. <https://doi.org/10.1016/j.egypro.2011.02.312>

178. GORRE, J., ORTLOFF, F., VAN LEEUWEN, C. 2019. *Production costs for synthetic methane in 2030 and 2050 of an optimized Power-to-Gas plant with intermediate hydrogen storage*. *Applied Energy*, 253, 113594. <https://doi.org/10.1016/j.apenergy.2019.113594>
179. GOTO, K., CHOWDHURY, F. A., OKABE, H., SHIMIZU, S., FUJIOKA, Y. 2011. *Development of a low cost CO<sub>2</sub> capture system with a novel absorbent under the COCS project*. *Energy Procedia*, 4, 253–258. <https://doi.org/10.1016/j.egypro.2011.01.049>
180. GOVERNMENT OF THE REPUBLIC OF CROATIA. 2022. *ODLUKA o donošenju Plana korištenja financijskih sredstava dobivenih od prodaje emisijskih jedinica putem dražbi u Republici Hrvatskoj od 2021. do 2025. godine*. Zagreb: Ministry of Economy and Sustainable Development
181. GRADSKA PLINARA ZAGREB - OPSKRBA [GPZ - Opskrba]. 2024. *Općenito o kvaliteti prirodnog plina*. <https://www.gpz-opskrba.hr/korisne-informacije/kvaliteta-prirodnog-plina-64/opcenito-o-kvaliteti-prirodnog-plina-254/254> (25.08.2024)
182. GRAF, K. 2011. *Determining Packing Height With Accuracy*. *Chemical Engineering*. <https://www.chemengonline.com/determining-packing-height-with-accuracy/> (25.07.2024)
183. GREEN, DR. D. W., SOUTHARD, Dr. M. Z. 2019. *Perry's Chemical Engineers' Handbook, 9th Edition*. McGraw-Hill Education.
184. GREENHOUSE GAS MANAGEMENT INSTITUTE, STOCKHOLM ENVIRONMENT INSTITUTE. n.d. *Allowances - Carbon Offset Guide*. <https://offsetguide.org/understanding-carbon-offsets/other-instruments-for-claiming-emission-reductions/allowances/> (25.07.2024)
185. GTG PLIN. 2023. Electronic mail with GTG plin, 28<sup>th</sup> July 2023.
186. GUO, Y., ZHANG, M., LIU, Z., TIAN, X., ZHANG, S., ZHAO, C., LU, H. 2018. *Modeling and Optimizing the Synthesis of Urea-formaldehyde Fertilizers and Analyses of Factors Affecting these Processes*. *Scientific Reports*, 8(1). <https://doi.org/10.1038/s41598-018-22698-8>
187. HAHN, W.-H., BAE, S. P., SONG, S., PARK, S., LEE, J., SEO, J.-B., KANG, N.

- M. 2018. *The freeze-drying does not influence the proteomic profiles of human milk*. The Journal of Maternal-Fetal & Neonatal Medicine, 33(12), 2069–2074. <https://doi.org/10.1080/14767058.2018.1538349>
188. HAMZA, A., HUSSEIN, I. A., AL-MARRI, M. J., MAHMOUD, M., SHAWABKEH, R., APARICIO, S. 2021. *CO<sub>2</sub> enhanced gas recovery and sequestration in depleted gas reservoirs: A review*. Journal of Petroleum Science and Engineering, 196, 107685. <https://doi.org/10.1016/j.petrol.2020.107685>
189. HEDGEWEEK. 2020. *EEX selected to host EU common auction platform for emission allowances for a further five years*. <https://www.hedgeweek.com/eex-selected-host-eu-common-auction-platform-emission-allowances-further-five/> (25.01.2024)
190. HEMETEK POTROŠKO, I. 2023. Electronic mail with Ines Hemetek Potroško, 1<sup>st</sup> September 2023.
191. HENKELMAN, S., NOORMAN, F., BADLOE, J. F., LAGERBERG, J. W. M. 2014. *Utilization and quality of cryopreserved red blood cells in transfusion medicine*. Vox Sanguinis, 108(2), 103–112. <https://doi.org/10.1111/vox.12218>
192. HEP OPSKRBA. 2023a. *Day tariff and night tariff in HEP PRO model*. [https://www.hep.hr/opskrba/UserDocsImages/opskrba%20-%20tarife/VT\\_NT.pdf](https://www.hep.hr/opskrba/UserDocsImages/opskrba%20-%20tarife/VT_NT.pdf) (25.08.2023)
193. HEP OPSKRBA. 2023b. Telephone call with HEP OPSKRBA d.o.o., 24<sup>th</sup> August 2023.
194. HEPBURN, C., ADLEN, E., BEDDINGTON, J., CARTER, E. A., FUSS, S., MAC DOWELL, N., MINX, J. C., SMITH, P., WILLIAMS, C. K. 2019. *The technological and economic prospects for CO<sub>2</sub> utilization and removal*. Nature, 575(7781), 87–97. <https://doi.org/10.1038/s41586-019-1681-6>
195. HIF GLOBAL. 2023. *HIF Haru Oni Demonstration Plant*. <https://hifglobal.com/haru-oni> (15.01.2023)
196. HILLER, H., REIMERT, R., STÖNNER, H. 2011. *Gas production, I. Introduction*. In *Ullmann's Encyclopedia of Industrial Chemistry*. Weinheim: Wiley-VCH Verlag GmbH & Co. KGaA. [https://doi.org/10.1002/14356007.a12\\_169.pub3](https://doi.org/10.1002/14356007.a12_169.pub3)



197. HO, H.-J., IIZUKA, A., SHIBATA, E. 2019. *Carbon capture and utilization technology without carbon dioxide purification and pressurization: A review on its necessity and available technologies*. *Industrial & Engineering Chemistry Research*, 58(21), 8941–8954. <https://doi.org/10.1021/acs.iecr.9b01213>
198. HOSSAIN, MD. J., SALMAN, H. M., AHMED, S. I., MONIR, M. U., TECHATO, K., CHOWDHURY, S., HABIB, MD. A., PHOUNGTHONG, K. 2023. 7 - *Separation and purification apparatus safety: Separators, trays, towers, etc.* In *Crises in Oil, Gas and Petrochemical Industries* (pp. 177–209). Amsterdam: Elsevier. <http://dx.doi.org/10.1016/b978-0-323-95163-0.00014-1>
199. HRVATSKA TEHNIČKA ENCIKLOPEDIJA. 2022. *Procesno projektiranje*. <https://tehnika.lzmk.hr/procesno-projektiranje/> (25.08.2023)
200. HUANG, W., ZHENG, D., XIE, H., LI, Y., WU, W. 2019. *Hybrid physical-chemical absorption process for carbon capture with strategy of high-pressure absorption/medium-pressure desorption*. *Applied Energy*, 239, 928–937. <https://doi.org/10.1016/j.apenergy.2019.02.007>
201. HUSSAIN, I., JALIL, A. A., HASSAN, N. S., HAMID, M. Y. S. 2021. *Recent advances in catalytic systems for CO<sub>2</sub> conversion to substitute natural gas (SNG): Perspective and challenges*. *Journal of Energy Chemistry*, 62, 377–407. <https://doi.org/10.1016/j.jechem.2021.03.040>
202. IEA. 2019a. *Can CO<sub>2</sub>-EOR really provide carbon-negative oil?* <https://www.iea.org/commentaries/can-co2-eor-really-provide-carbon-negative-oil> (25.08.2023)
203. IEA. 2019b. *Putting CO<sub>2</sub> to Use*. Report. <https://www.iea.org/reports/putting-co2-to-use>. Paris: IEA.
204. IEA. 2020. *CCUS in Clean Energy Transitions*. Report. <https://www.iea.org/reports/ccus-in-clean-energy-transitions>. Paris: IEA.
205. IEA. 2021. *Is carbon capture too expensive?* <https://www.iea.org/commentaries/is-carbon-capture-too-expensive>. (25.10.2023)
206. IEA. 2024. *World Energy Investment 2024*. Report.

<https://www.iea.org/reports/world-energy-investment-2024>. Paris: IEA.

207. INDEPENDENT COMMODITY INTELLIGENCE Services. 2022. *EPCA '22: European shut ammonia production unlikely to return – analyst*. <https://www.icis.com/explore/resources/news/2022/10/04/10811649/epca-22-european-shut-ammonia-production-unlikely-to-return-analyst/> (20.08.2024)
208. INDEX.HR. 2022. *U Njemačkoj problemi, u Hrvatskoj nije ugrožena proizvodnja piva*. <https://www.index.hr/vijesti/clanak/u-hrvatskoj-nema-nestacije-co2-kao-u-njemackoj-proizvodnja-piva-nije-ugrozena/2396943.aspx> (25.10.2022)
209. INTERNATIONAL CARBON ACTION PARTNERSHIP. n.d. *USA - California Cap-and-Trade Program*. <https://icapcarbonaction.com/en/ets/usa-california-cap-and-trade-program> (25.05.2023)
210. INTERNATIONAL INSTITUTE FOR SUSTAINABLE DEVELOPMENT [IISD]. 2023. *Why the Cost of Carbon Capture and Storage Remains Persistently High*. <https://www.iisd.org/articles/deep-dive/why-carbon-capture-storage-cost-remains-high> (25.01.2024)
211. INTERNATIONAL ORGANIZATION FOR STANDARDIZATION. 2015. ISO 6141:2015. *Gas analysis — Contents of certificates for calibration gas mixtures*. Vernier: ISO
212. INTERNATIONAL ORGANIZATION FOR STANDARDIZATION. 2024. ISO/DIS 27927. *Carbon dioxide capture — Key performance parameters and characterization methods of absorption liquids for post-combustion CO<sub>2</sub> capture*. Vernier: ISO
213. INTRATEC SOLUTIONS. 2024. *Monoethanolamine Prices | Historical and Current*. <https://www.intratec.us/chemical-markets/monoethanolamine-price> (20.08.2024)
214. INVESTOPEDIA. 2024a. *Capital Expenditure (CapEx) Definition, Formula, and Examples*. <https://www.investopedia.com/terms/c/capitalexpenditure.asp> (23.08.2023)
215. INVESTOPEDIA. 2024b. *Net Present Value (NPV): What It Means and Steps to Calculate It*. <https://www.investopedia.com/terms/n/npv.asp> (23.08.2023)
216. IRLAM, L. 2017. *GLOBAL COSTS OF CARBON CAPTURE AND STORAGE 2017*

<https://web.archive.org/web/20240129145045/https://www.globalccsinstitute.com/archive/hub/publications/201688/global-ccs-cost-updatev4.pdf>

217. IRWIN, S. 2024. *CO<sub>2</sub> Production by the U.S. Ethanol Industry and the Potential Value of Sequestration*. *Farmdoc Daily*, 14(34).
218. JAMES O2. n.d. *10 Questions & Answers About Draft Beer CO<sub>2</sub>*. <https://www.jameso2.com/draft-beer-co2/> (23.12.2023)
219. JANSEN, D., GAZZANI, M., MANZOLINI, G., DIJK, E. VAN, CARBO, M. 2015. Pre-combustion CO<sub>2</sub> capture. *International Journal of Greenhouse Gas Control*, 40, 167–187. <https://doi.org/10.1016/j.ijggc.2015.05.028>
220. JÄRVINEN, A., LEHTORANTA, K., AAKKO-SAKSA, P., KARPPANEN, M., MURTONEN, T., MARTIKAINEN, J., KUUSISTO, J., NYSSÖNEN, S., KOPONEN, P., PIIMÄKORPI, P., FRIMAN, E., ORASUO, V., RINTANEN, J., JOKILUOMA, J., KUITTINEN, N., RÖNKKÖ, T. 2023. *Performance of a wet electrostatic precipitator in marine applications*. *Journal of Marine Science and Engineering*, 11(2), 393. <https://doi.org/10.3390/jmse11020393>
221. JONES, D. A. 2018. *Technoeconomic Evaluation of MEA versus Mixed Amines and a Catalyst System for CO<sub>2</sub> Removal at Near-Commercial Scale at Duke Energy Gibson 3 Plant and Duke Energy Buck NGCC Plant*. <https://www.osti.gov/biblio/1476188>
222. JOVIĆ, M. 2016. *Uzorkovanje komaraca tijekom 2015. godine na području Međimurske županije* [Master thesis, University of Applied Health Sciences]. <https://urn.nsk.hr/urn:nbn:hr:139:690176>
223. JOVIĆ, M. 2017. *Uzorkovanje komaraca tijekom 2015. godine na području Međimurske županije*. *Nove Staze* Nr. 34, 34–36. [https://www.zzjz-kkz.hr/dokumenti/Nove\\_staze\\_broj\\_34.pdf](https://www.zzjz-kkz.hr/dokumenti/Nove_staze_broj_34.pdf)
224. JURIC, I. 2021. *Održavanje stabilnog sustava za gašenje požara s CO<sub>2</sub>* [Master thesis, Karlovac University of Applied Sciences]. <https://urn.nsk.hr/urn:nbn:hr:128:795812>
225. KAH, P., MARTIKAINEN, J. 2012. *Influence of shielding gases in the welding of metals*. *The International Journal of Advanced Manufacturing Technology*, 64(9–12), 1411–

1421. <https://doi.org/10.1007/s00170-012-4111-6>
226. KALLEVIK, O. B. 2010. *Cost estimation of CO2 removal in HYSYS* [Master thesis, University of South-Eastern Norway]. <https://openarchive.usn.no/usn-xmlui/handle/11250/2439023>
227. KARDUM, Z. 2014. *Priručnik za osposobljavanje iz zaštite od požara*. Zagreb: HD usluge d.o.o. [https://issuu.com/hdusluge/docs/prirucnik\\_za\\_osposobljavanje\\_iz\\_za/21](https://issuu.com/hdusluge/docs/prirucnik_za_osposobljavanje_iz_za/21)
228. KHAN, U., OGBAGA, C. C., ABIODUN, O.-A. O., ADELEKE, A. A., IKUBANNI, P. P., OKOYE, P. U., OKOLIE, J. A. 2023. *Assessing absorption-based CO2 capture: Research progress and techno-economic assessment overview*. Carbon Capture Science & Technology, 8, 100125. <https://doi.org/10.1016/j.ccst.2023.100125>
229. KILLINGLAND, M., BOGE, M. K., MAGNESCHI, G. 2020. *THE NORWEGIAN FULL-SCALE CCS DEMONSTRATION PROJECT - Potential for reduced costs for carbon capture, transport and storage value chains (CCS)*. Porsgrunn: Gassnova SF. <https://ccsnorway.com/app/uploads/sites/6/2020/07/Report-Cost-reduction-curves-for-CCS-Gassnova-version-2b-1.pdf>
230. KIMRAY.COM. 2023. *Gas Absorber Tower: How the 3 Types Work to Dehydrate Your Natural Gas*. <https://kimray.com/training/gas-absorber-tower-how-3-types-work-dehydrate-your-natural-gas> (26.01.2024)
231. KNAPIK, E., KOSOWSKI, P., STOPA, J. 2018. *Cryogenic liquefaction and separation of CO2 using nitrogen removal unit cold energy*. Chemical Engineering Research and Design, 131, 66–79. <https://doi.org/10.1016/j.cherd.2017.12.027>
232. KOHLI, R. 2019. *Applications of solid carbon dioxide (dry ice) pellet blasting for removal of surface contaminants*. In *Developments in Surface Contamination and Cleaning: Applications of Cleaning Techniques* (pp. 117–169). Amsterdam: Elsevier. <http://dx.doi.org/10.1016/b978-0-12-815577-6.00004-9>
233. KOSAKA, F., SASAYAMA, T., LIU, Y., CHEN, S.-Y., MOCHIZUKI, T., MATSUOKA, K., URAKAWA, A., KURAMOTO, K. 2022. *Direct and continuous conversion of flue gas CO2 into green fuels using dual function materials in a circulating fluidized bed system*. Chemical Engineering Journal, 450, 138055.

<https://doi.org/10.1016/j.cej.2022.138055>

234. KOSIN, P., SAVEL, J., EVANS, D. E., BROZ, A. 2012. *How the method of beer dispense influences the served co2content and the sensory profile of beer*. Journal of the American Society of Brewing Chemists, 70(2), 103–108. <https://doi.org/10.1094/asbcj-2012-0315-01>
235. KOSIR, D. 2017. *Ekstrakcija eteričnog ulja i koncentrata iz smilja* [Master thesis, Faculty of Chemical Engineering and Technology]. <https://urn.nsk.hr/urn:nbn:hr:149:178716>
236. KOTHANDARAMAN, A. 2010. *Carbon dioxide capture by chemical absorption : A solvent comparison study* [PhD Thesis, Massachusetts Institute of Technology. Dept. of Chemical Engineering.]. <https://dspace.mit.edu/handle/1721.1/59877>
237. KRIZMANIĆ, P. 2016. *Postupak ispitivanja dimnih plinova* [Master thesis, Faculty of Mechanical Engineering and Naval Architecture, University of Zagreb]. <https://urn.nsk.hr/urn:nbn:hr:235:946264>
238. KRUŽIĆ, V. 2021. *Mogućnost negativnih emisija utilizacijom CO2 u slučaju poboljšane proizvodnje prirodnog plina* [Bachelor Thesis, Faculty of Mining, Geology and Petroleum Engineering, University of Zagreb]. <https://urn.nsk.hr/urn:nbn:hr:169:167609>
239. KUMAR, S., ZARZOUR, O., KING, G., CARBON, M. 2010. *Design of CO2 Dehydration and Compression Facilities*. Paper Presented at the Abu Dhabi International Petroleum Exhibition and Conference, Abu Dhabi, UAE, November 2010. <http://dx.doi.org/10.2118/137284-ms>
240. LAI, J. Y., NGU, L. H., HASHIM, S. S. 2021. *A review of CO2 adsorbents performance for different carbon capture technology processes conditions*. Greenhouse Gases: Science and Technology, 11(5), 1076–1117. <https://doi.org/10.1002/ghg.2112>
241. LAUERMANN, G., HÄUSSINGER, P., LOHMÜLLER, R., WATSON, A. M. 2013. *Hydrogen, 1. Properties and occurrence*. In *Ullmann's Encyclopedia of Industrial Chemistry*. Weinheim: Wiley-VCH Verlag GmbH & Co. KGaA. [https://onlinelibrary.wiley.com/doi/10.1002/14356007.a13\\_297.pub3](https://onlinelibrary.wiley.com/doi/10.1002/14356007.a13_297.pub3)
242. LEBEDEVAS, S., MALŪKAS, A. 2024. *The application of cryogenic carbon*

- capture technology on the dual-fuel ship through the utilisation of LNG cold potential.* Journal of Marine Science and Engineering, 12(2), 217. <https://doi.org/10.3390/jmse12020217>
243. LECOMTE, T., FERRERIA DE LA FUENTE, J. F., NEUWAHL, F., CANOVA, M., PINASSEAU, A., JANKOV, I., BRINKMANN, T., ROUDIER, S., DELGADO, S. L. 2017. *Best Available Techniques (BAT) Reference Document for Large Combustion Plants. Industrial Emissions Directive 2010/75/EU (Integrated Pollution Prevention and Control).* Publications Office of the European Union. <https://publications.jrc.ec.europa.eu/repository/handle/JRC107769>
244. LEESON, D., MAC DOWELL, N., SHAH, N., PETIT, C., FENNELL, P. S. 2017. *A Techno-economic analysis and systematic review of carbon capture and storage (CCS) applied to the iron and steel, cement, oil refining and pulp and paper industries, as well as other high purity sources.* International Journal of Greenhouse Gas Control, 61, 71–84. <https://doi.org/10.1016/j.ijggc.2017.03.020>
245. LEWIS, A. C. 2021. *Optimising air quality co-benefits in a hydrogen economy: A case for hydrogen-specific standards for NO<sub>x</sub> emissions.* Environmental Science: Atmospheres, 1(5), 201–207. <https://doi.org/10.1039/d1ea00037c>
246. LEWIS, M. J., YOUNG, T. W. 2001. *Beer packaging and dispense.* In *Brewing* (pp. 351–368). Boston: Springer US. [http://dx.doi.org/10.1007/978-1-4615-0729-1\\_20](http://dx.doi.org/10.1007/978-1-4615-0729-1_20)
247. LI, H. 2008. *Thermodynamic Properties of CO<sub>2</sub> Mixtures and Their Applications in Advanced Power Cycles with CO<sub>2</sub> Capture Processes* [PhD thesis, Department of Chemical Engineering and Technology, Royal Institute of Technology, Sweden]. <https://kth.diva-portal.org/smash/record.jsf?pid=diva2%3A15031&dswid=-6029>
248. LI, N., MO, L., UNLUER, C. 2022. *Emerging CO<sub>2</sub> utilization technologies for construction materials: A review.* Journal of CO<sub>2</sub> Utilization, 65, 102237. <https://doi.org/10.1016/j.jcou.2022.102237>
249. LI, Y., DING, Y., LI, D., MIAO, Z. 2018. *Automatic carbon dioxide enrichment strategies in the greenhouse: A review.* Biosystems Engineering, 171, 101–119. <https://doi.org/10.1016/j.biosystemseng.2018.04.018>

250. LI, Z., CHEN, S., HOPKINSON, D., LUEBKE, D. 2015. *Verification of a solvent optimization approach for postcombustion CO<sub>2</sub> capture using commercial alkanolamines*. *International Journal of Greenhouse Gas Control*, 44. <https://doi.org/10.1016/j.ijggc.2015.11.002>
251. LIANG, Z. H., SANPASERTPARNICH, T., TONTIWACHWUTHIKUL, P. P., GELOWITZ, D., IDEM, R. 2014. *Part 1: Design, modeling and simulation of post-combustion CO<sub>2</sub> capture systems using reactive solvents*. *Carbon Management*, 2(3), 265–288. <https://doi.org/10.4155/cmt.11.19>
252. LIM, J., KIM, J. 2022. *Designing and integrating NO<sub>x</sub>, SO<sub>2</sub> and CO<sub>2</sub> capture and utilization process using desalination wastewater*. *Fuel*, 327, 124986. <https://doi.org/10.1016/j.fuel.2022.124986>
253. LINDE GAS SCHWEIZ. 2024a. *Kohlendioxid*. <https://www.linde.ch/shop/de/ch-ig/ig-gase-de/ig-kohlendioxid-de> (23.08.2024)
254. LINDE GAS SCHWEIZ. 2024b. *Kohlendioxid, CO<sub>2</sub> (verdichtet, unter Druck verflüssigt)*. Dagmersellen: Linde Gas Schweiz AG. [https://www.linde.ch/wcsstore/CH\\_REC\\_Industrial\\_Ntl\\_Store/datasheets/de\\_CH/MS-27463-kohlendioxid-kk-3-4-5-r744-dfie.pdf](https://www.linde.ch/wcsstore/CH_REC_Industrial_Ntl_Store/datasheets/de_CH/MS-27463-kohlendioxid-kk-3-4-5-r744-dfie.pdf) (23.08.2024)
255. LINDE. 2017a. *Gases & Applications*. Pullach: Linde. [https://static.prd.echannel.linde.com/wcsstore/NL\\_RES\\_Industrial\\_Gas\\_Store/Attachment/Downloads/Gases\\_and\\_Applications\\_eBook\\_Linde\\_Gas.pdf](https://static.prd.echannel.linde.com/wcsstore/NL_RES_Industrial_Gas_Store/Attachment/Downloads/Gases_and_Applications_eBook_Linde_Gas.pdf) (03.01.2024)
256. LINDE. 2017b. *Safety advice. Carbon Dioxide*. Pullach: Linde. [https://web.archive.org/web/20240117175241/https://www.linde-gas.com/en/images/LMB\\_Safety%20Advice\\_01\\_66881\\_tcm17-165650.pdf](https://web.archive.org/web/20240117175241/https://www.linde-gas.com/en/images/LMB_Safety%20Advice_01_66881_tcm17-165650.pdf) (03.01.2024)
257. LINDE. 2024. *Carbon Dioxide Replaces Mineral Acid to Reduce pH*. <https://www.lindeus.com/industries/water-and-wastewater-treatment/wastewater-treatment/ph-control> (03.01.2024)
258. LINDE. n.d.-a. *Atmospheric Gases: Carbon Dioxide. Tapping Both Industrial and Natural Sources for Flexibility of Supply and Carbon Mitigation*. [https://www.linde-gas.com/en/products\\_and\\_supply/gases\\_atmospheric/carbon\\_dioxide.html](https://www.linde-gas.com/en/products_and_supply/gases_atmospheric/carbon_dioxide.html) (03.01.2024)

259. LINDE. n.d.-b. *Carbonation*.  
[https://web.archive.org/web/20240221214911/https://www.linde-gas.com/en/processes/controlled\\_and\\_modified\\_atmospheres/carbonation/index.html](https://web.archive.org/web/20240221214911/https://www.linde-gas.com/en/processes/controlled_and_modified_atmospheres/carbonation/index.html)  
 (03.01.2024)
260. LINDE. n.d.-c. *Controlled Atmosphere Stunning (CAS)*.  
[https://web.archive.org/web/20240228113612/https://www.linde-gas.com/en/processes/controlled\\_and\\_modified\\_atmospheres/controlled\\_atmosphere\\_stunning/index.html](https://web.archive.org/web/20240228113612/https://www.linde-gas.com/en/processes/controlled_and_modified_atmospheres/controlled_atmosphere_stunning/index.html) (03.01.2024)
261. LINDE. n.d.-d. *Dry Ice*.  
[https://web.archive.org/web/20240227014403/https://www.linde-gas.com/en/products\\_and\\_supply/food\\_chilling\\_cooling/dry\\_ice\\_sol.html](https://web.archive.org/web/20240227014403/https://www.linde-gas.com/en/products_and_supply/food_chilling_cooling/dry_ice_sol.html) (03.01.2024)
262. LINDE. n.d.-e. *Enhancing Greenhouse Growth*.  
[https://web.archive.org/web/20240227002855/https://www.linde-gas.com/en/processes/controlled\\_and\\_modified\\_atmospheres/greenhouses/index.html](https://web.archive.org/web/20240227002855/https://www.linde-gas.com/en/processes/controlled_and_modified_atmospheres/greenhouses/index.html)  
 (03.01.2024)
263. LINDE. n.d.-f. *Fumigation & Pest Control*.  
[https://web.archive.org/web/20240228121012/https://www.linde-gas.com/en/processes/fumigation\\_and\\_pest\\_control/index.html](https://web.archive.org/web/20240228121012/https://www.linde-gas.com/en/processes/fumigation_and_pest_control/index.html) (03.01.2024)
264. LINDE. n.d.-g. *In-Transit Refrigeration & Catering*.  
[https://web.archive.org/web/20240228112154/https://www.linde-gas.com/en/products\\_and\\_supply/food\\_chilling\\_cooling/transport\\_controlled\\_temperature.html](https://web.archive.org/web/20240228112154/https://www.linde-gas.com/en/products_and_supply/food_chilling_cooling/transport_controlled_temperature.html) (03.01.2024)
265. LINDE. n.d.-h. *Modified Atmosphere Packaging (MAP)*.  
[https://web.archive.org/web/20240221224758/https://www.linde-gas.com/en/processes/controlled\\_and\\_modified\\_atmospheres/modified\\_atmosphere\\_packaging/index.html](https://web.archive.org/web/20240221224758/https://www.linde-gas.com/en/processes/controlled_and_modified_atmospheres/modified_atmosphere_packaging/index.html) (03.01.2024)
266. LINDE. n.d.-i. *Product information: BIOGON® food grade gases. BIOGON® C (E 290). Carbon dioxide, CO<sub>2</sub>*. Pullach: Linde. [https://www.linde-gas.no/en/images/Linde\\_BIOGON%20C%20Datasheet%20EN\\_tcm630-483768.pdf](https://www.linde-gas.no/en/images/Linde_BIOGON%20C%20Datasheet%20EN_tcm630-483768.pdf)



(03.01.2024)

267. LINDE. n.d.-j. *Tapping Both Industrial and Natural Sources for Flexibility of Supply and Carbon Mitigation*. <https://www.linde-gas.com/what-we-offer/gases/atmospheric-gases/carbon-dioxide> (03.01.2024)

268. LIOVIĆ, M. 2021. *Mehanizam rada i raspon djelovanja ventila za plinsko podizanje* [Bachelor Thesis, Faculty of Mining, Geology and Petroleum Engineering, University of Zagreb]. <https://urn.nsk.hr/urn:nbn:hr:169:551103>

269. LIU, B., LUO, X., GAO, H., IDEM, R., TONTIWACHWUTHIKUL, P., OLSON, W., LIANG, Z. 2017. *Reaction kinetics of the absorption of carbon dioxide (CO<sub>2</sub>) in aqueous solutions of sterically hindered secondary alkanolamines using the stopped-flow technique*. *Chemical Engineering Science*, 170, 16–25. <https://doi.org/10.1016/j.ces.2017.02.044>

270. LIU, S.-Y., REN, B., LI, H.-Y., YANG, Y.-Z., WANG, Z.-Q., WANG, B., XU, J.-C., AGARWAL, R. 2022. *CO<sub>2</sub> storage with enhanced gas recovery (CSEGR): A review of experimental and numerical studies*. *Petroleum Science*, 19(2), 594–607. <https://doi.org/10.1016/j.petsci.2021.12.009>

271. LIU, Z., YANG, X., JIA, W., LI, H., YANG, X. 2020. *Justification of CO<sub>2</sub> as the working fluid for a compressed gas energy storage system: A thermodynamic and economic study*. *Journal of Energy Storage*, 27, 101132. <https://doi.org/10.1016/j.est.2019.101132>

272. LNG Hrvatska. 2022b. *Glavne tehničke karakteristike*. <https://lng.hr/terminal/glavne-tehnicke-karakteristike/> (03.10.2022)

273. LNG Hrvatska. 2022c. *Terminal - LNG Hrvatska*. <https://lng.hr/terminal/> (03.10.2022)

274. LNG Hrvatska. 2023c. *Potpisan ugovor za isporuku dodatnog modula za uplinjavanje*. <https://lng.hr/2023/04/14/potpisan-ugovor-za-isporku-dodatnog-modula-za-uplinjavanje> (03.07.2023)

275. LNG HRVATSKA. 2022a. Electronic mail with LNG Hrvatska, 5<sup>th</sup> October 2022.

276. LNG HRVATSKA. 2023a. Electronic mail with LNG Hrvatska, 26<sup>th</sup> January 2023.

277. LNG HRVATSKA. 2023b. Electronic mail with LNG Hrvatska, 24<sup>th</sup> August 2023.

278. LNG HRVATSKA. 2024. Electronic mail with LNG Hrvatska, 9<sup>th</sup> September 2024.
279. LNG Prime. 2020. *Croatian first FSRU arrives in Rijeka*. LNG Prime. <https://lngprime.com/vessels/croatian-first-fsru-arrives-in-rijeka/5333/> (30.08.2024)
280. LONG, B., RYAN, K. M., PADRELA, L. 2019. *From batch to continuous — New opportunities for supercritical CO<sub>2</sub> technology in pharmaceutical manufacturing*. *European Journal of Pharmaceutical Sciences*, 137, 104971. <https://doi.org/10.1016/j.ejps.2019.104971>
281. LU, S., YANG, F., ZHANG, J., WANG, N., LIU, L., KANG, G., ZHAO, D., YU, X., LI, Q. 2023. *Experimental analysis of reaction heat of CO<sub>2</sub> absorption of phase change absorber AEP-DPA at low partial pressure*. *Energies*, 16(4). <https://doi.org/10.3390/en16041867>
282. LU, Y., LU, H., NIELSEN, P., WHITTAKER, S. 2020. *Modeling assessment of retrofitting power plants and industrial facilities for carbon capture and storage in the Illinois Basin (Task 10)*. <https://www.osti.gov/biblio/1871169>
283. LV, B., GUO, B., ZHOU, Z., JING, G. 2015. *Mechanisms of CO<sub>2</sub> capture into monoethanolamine solution with different CO<sub>2</sub> loading during the absorption/desorption processes*. *Environmental Science & Technology*, 49(17), 10728–10735. <https://doi.org/10.1021/acs.est.5b02356>
284. MA, C., PIETRUCCHI, F., ANDREONI, W. 2023. *CO<sub>2</sub> capture and release in amine solutions: To what extent can molecular simulations help understand the trends?*. *Molecules*, 28(18). <https://doi.org/10.3390/molecules28186447>
285. MA'MUN, S. 2005. *Selection and Characterization of New Absorbents for Carbon Dioxide Capture* [PhD Thesis, Norwegian University of Science and Technology]. <https://ntnuopen.ntnu.no/ntnu-xmlui/handle/11250/248080>
286. MACDOUGALL, SCOTT, ARNOLD, JONATHAN, MCKENZIE, J. 2023. *Cash flow modeling shows carbon capture and storage can help meet climate goals*. The Pembina Institute. <https://www.pembina.org/pub/cash-flow-modeling-shows-carbon-capture-storage-can-help-meet-climate-goals>
287. MACHADO, B. A. S., PEREIRA, C. G., NUNES, S. B., PADILHA, F. F., UMSZA-

- GUEZ, M. A. 2013. *Supercritical fluid extraction using CO<sub>2</sub>: Main applications and future perspectives*. Separation Science and Technology, 48(18), 2741–2760. <https://doi.org/10.1080/01496395.2013.811422>
288. MAČKOVIĆ, M. 2012. *Eksperimentalno istraživanje učinkovitosti inertizacije eksplozivnih atmosfera* [Master thesis, Faculty of Mechanical Engineering and Naval Architecture, University of Zagreb]. <https://urn.nsk.hr/urn:nbn:hr:235:925107>
289. MADEDDU, C., ERRICO, M., BARATTI, R. 2017. *Rigorous Modeling of a CO<sub>2</sub>-MEA Stripping System*. Proceedings of the 13th International Conference on Chemical and Process Engineering, 57, 451–456. <https://portal.findresearcher.sdu.dk/en/publications/rigorous-modeling-of-a-co2-mea-stripping-system>
290. MAĐERIĆ, D., KONDIĆ, Ž., BOTAK, Z. 2007. *CO<sub>2</sub> kao radna tvar u suvremenim rashladnim sustavima*. Tehnički Glasnik, 1(1–2), 24–30.
291. MAHAPATRA, M. P. 2023. *The Price Tag of Carbon Capture: Analysis of the Economics of CCUS*. LinkedIn. <https://www.linkedin.com/pulse/price-tag-carbon-capture-analysis-economics-ccus-mahapatra-pmp-/>
292. MAJIĆ, M. 2017. *Ekološke prednosti, rizici i monitoring utiskivanja CO<sub>2</sub> u podzemlje* [Master thesis, Faculty of Mining, Geology and Petroleum Engineering, University of Zagreb]. <https://repozitorij.rgn.unizg.hr/islandora/object/rgn:550>
293. MAKARYAN, I. A., SALGANSKY, E. A., ARUTYUNOV, V. S., SEDOV, I. V. 2023. *Non-Catalytic partial oxidation of hydrocarbon gases to syngas and hydrogen: A systematic review*. Energies, 16(6). <https://doi.org/10.3390/en16062916>
294. MAKUL, N. 2021. *Towards computational CO<sub>2</sub> capture and storage models*. The Global Environmental Engineers, 8, 55–69. <https://doi.org/10.15377/2410-3624.2021.08.5>
295. MAN ENERGY SOLUTIONS. 2023. *The e-fuels revolution at the “End of the World.”* <https://www.man-es.com/discover/haru-oni-e-fuels> (30.12.2023)
296. MARCO, I. D., RIEMMA, S., IANNONE, R. 2017. *Supercritical carbon dioxide decaffeination process: A life cycle assessment study*. Chemical Engineering Transactions, 57, 1699–1704. <https://doi.org/10.3303/CET1757284>

297. MARKETSCREENER. 2024. *BASF: Plant shutdowns are a sign of changes in the chemical industry.* <https://uk.marketscreener.com/quote/stock/BASF-SE-6443227/news/BASF-Plant-shutdowns-are-a-sign-of-changes-in-the-chemical-industry-47015115/> (30.08.2024)
298. MARKOV, I. 2022. *Tehno-ekonomska analiza cjevovodnog transporta CO<sub>2</sub> u Republici Hrvatskoj* [Master thesis, Faculty of Mining, Geology and Petroleum Engineering, University of Zagreb]. <https://repositorij.rgn.unizg.hr/islandora/object/rgn%3A1937>
299. MARTIĆ, V. 2014. *Promjene koje nastaju tijekom čuvanja koncentrata eritrocita* [Bachelor Thesis, University Department of Health Studies, University of Split]. <https://urn.nsk.hr/urn:nbn:hr:176:316691>
300. MASSACHUSETTS INSTITUTE OF TECHNOLOGY. 1982. *Computed-aided industrial process design. The ASPEN Project. Final report, June 1, 1976 to November 30, 1981.* ASPEN). <https://www.osti.gov/biblio/5385627>
301. MAXWELL, C. 2024. *Cost Indices.* In *Towering Skills.* <https://toweringskills.com/financial-analysis/cost-indices/> (30.08.2024)
302. MCCANN, N., MAEDER, M., HASSE, H. 2011. *Prediction of the overall enthalpy of CO<sub>2</sub> absorption in aqueous amine systems from experimentally determined reaction enthalpies.* Energy Procedia, 4, 1542–1549. <https://doi.org/10.1016/j.egypro.2011.02.023>
303. MCMASTER UNIVERSITY. 2023a. *Dr. Vladimir Mahalec – Faculty of Engineering.* <https://www.eng.mcmaster.ca/chemeng/faculty/dr-vladimir-mahalec/> (30.04.2024)
304. MCMASTER UNIVERSITY. 2023b. *Dr. Vladimir Mahalec Professor and Associate Director.* <https://macc.mcmaster.ca/macc/MACCRResearcher/4> (30.04.2024)
305. MECHANICREALM.COM. 2022. *Electrostatic Precipitator Working Principle.* <https://mechanicrealm.com/electrostatic-precipitator-working-principle/> (16.02.2023)
306. MEIXNER, I., KARAŠIĆ, M., KRIŠKOVIĆ, D., MARKOTA, B., KRAJINA, D., ALIĆAJIĆ, G., DUBOVEČAK, I. 2013. *Tehničko - tehnološko rješenje postrojenja Messer Croatia Plin d.o.o. – pogona Kutina.* Rijeka: DLS d.o.o. <https://mingo.gov.hr/UserDocsImages/Okoli%C5%A1na%20dozvola/OUZO->

[postoje%C4%87e/Tehnicko-tehnolosko\\_rjesenje\\_\(Messer\).pdf](#) (16.07.2023)

307. MENEGHEL, J., KILBRIDE, P., MORRIS, G. J. 2020. *Cryopreservation as a key element in the successful delivery of cell-based therapies—a review*. *Frontiers in Medicine*, 7. <https://doi.org/10.3389/fmed.2020.592242>
308. MESSER. 2023a. Electronic mail with Messer, 31<sup>st</sup> August 2023.
309. MESSER. 2023b. Telephone call with Messer, 28<sup>th</sup> July 2023.
310. METROALFA. 2020. *Izveštaj o ocjeni rezultata emisija onečišćujućih tvari u zrak iz nepokretnog izvora tvrtke GOLAR VIKING MANAGEMENT d.o.o., Zrinski Frankopanska 64, 21000 Split Plutajući terminal za prihvata, skladištenje i uplinjavanje LNG-a*. Report. Zagreb: Metroalfa d.o.o., I-1041-1-13-20-RM.
311. METROALFA. 2022. *Izveštaj o ocjeni rezultata emisija onečišćujućih tvari u zrak iz nepokretnog izvora tvrtke GOLAR VIKING MANAGEMENT d.o.o., Zrinski Frankopanska 64, 21000 Split Plutajući terminal za prihvata, skladištenje i uplinjavanje LNG-a*. Report. Zagreb: Metroalfa d.o.o., I-75-1-13-22-RM.
312. MICHAELS, A. 2024. *Analysis of methods to calculate efficiency in packed columns: HETP and HTU*. Engineeringness. <https://engineeringness.com/analysis-of-methods-to-calculate-efficiency-in-packed-columns-hetp-and-htu/> (16.02.2024)
313. MICHEL, S. G., LAMURAGLIA II, G. M., MADARIAGA, M. L. L., ANDERSON, L. M. 2015. *Innovative cold storage of donor organs using the Paragonix Sherpa Pak™ devices*. *Heart, Lung and Vessels*, 7(3), 246–255.
314. MIKULANDRIĆ, I. 2023. Electronic mail with Robert Mikulandrić, 10<sup>th</sup> June 2023.
315. MIKULIĆ, F. 2023. *Thermodynamic aspects of natural gas liquefaction and regasification processes at the LNG terminal* [Master thesis, Faculty of Chemical Engineering and Technology, University of Zagreb]. <https://urn.nsk.hr/urn:nbn:hr:149:312894>
316. MILNER, C. P., TRENGOVE, R. D., BIGNELL, C. M., DUNLOP, P. J. 1997. *Supercritical CO<sub>2</sub> extraction of the essential oils of eucalypts: A comparison with other methods*. In *Modern Methods of Plant Analysis* (pp. 141–158). Berlin: Springer Berlin Heidelberg. [http://dx.doi.org/10.1007/978-3-662-03331-9\\_7](http://dx.doi.org/10.1007/978-3-662-03331-9_7)

317. MINES PARIS – PSL. n.d. *Stoichiometric combustion*. [https://diren.mines-paristech.fr/Sites/Thopt/DiapTradJS/doc/S15\\_En/Combustion.pdf](https://diren.mines-paristech.fr/Sites/Thopt/DiapTradJS/doc/S15_En/Combustion.pdf) (16.02.2024)
318. MINISTRY OF ECONOMY AND SUSTAINABLE DEVELOPMENT [MINGOR]. 2022. *Izvešće o korištenju financijskih sredstava dobivenih od prodaje emisijskih jedinica putem dražbi u Republici Hrvatskoj u 2019. i 2020.* Zagreb: MINGOR. [https://mingo.gov.hr/UserDocsImages/klimatske\\_aktivnosti/izvjesca/drazbe/izvjesce\\_o\\_koristenju\\_prihoda\\_2019\\_2020.pdf](https://mingo.gov.hr/UserDocsImages/klimatske_aktivnosti/izvjesca/drazbe/izvjesce_o_koristenju_prihoda_2019_2020.pdf) (16.02.2023)
319. MINISTRY OF ECONOMY AND SUSTAINABLE DEVELOPMENT. 2023. *Izvešće o inventaru stakleničkih plinova na području Republike Hrvatske za razdoblje 1990. – 2021. NIR 2023.* Zagreb: MINGOR. [https://www.haop.hr/sites/default/files/uploads/dokumenti/012\\_klima/dostava\\_podataka/Izvjesca/Hrvatski%20NIR%202023.pdf](https://www.haop.hr/sites/default/files/uploads/dokumenti/012_klima/dostava_podataka/Izvjesca/Hrvatski%20NIR%202023.pdf) (16.02.2024)
320. MINISTRY OF ECONOMY. 2024. *Sustav trgovanja emisijama stakleničkih plinova.* <https://mingo.gov.hr/o-ministarstvu-1065/djelokrug/uprava-za-klimatske-aktivnosti-1879/sustav-trgovanja-emisijama-staklenickih-plinova/1890> (16.02.2024)
321. MIZUNO, A. 2000. *Electrostatic precipitation*. IEEE Transactions on Dielectrics and Electrical Insulation, 7(5), 615–624. <https://doi.org/10.1109/94.879357>
322. MOCH, J. M., XUE, W., HOLDREN, J. P. 2022. *Carbon Capture, Utilization, and Storage: Technologies and Costs in the U.S. Context*. Cambridge, Massachusetts, USA: Harvard Kennedy School Belfer Center for Science and International Affairs. <https://www.belfercenter.org/publication/carbon-capture-utilization-and-storage-technologies-and-costs-us-context> (16.12.2023)
323. MOK, Y. S., JWA, E., LEE, H. W. 2013. *Production of methane from carbon monoxide and carbon dioxide in a plasma-catalytic combined reactor system*. International Journal of Sustainable Development and Planning, 8(2), 186–196. <https://doi.org/10.2495/sdp-v8-n2-186-196>
324. MUKHERJEE, S., SAMANTA, A. N. 2019. *Heat of Absorption of CO<sub>2</sub> and Heat Capacity Measurements in Aqueous Solutions of Benzylamine, N-(2-Aminoethyl)-ethanolamine, and Their Blends Using a Reaction Calorimeter*. Journal of Chemical &

- Engineering Data, 64(8), 3392–3406. <https://doi.org/10.1021/acs.jced.9b00205>
325. NADY, S., FADIL, H. E., KOUNDI, M., HAMED, A., GIRI, F. 2022. *Power to X systems: STATE-OF-THE-ART (PTX)*. IFAC-PapersOnLine, 55(12), 300–305. <https://doi.org/10.1016/j.ifacol.2022.07.328>
326. NARODNE NOVINE no. 127/19. *Zakon o klimatskim promjenama i zaštiti ozonskog sloja*. Zagreb: Narodne novine d.d.
327. NARODNE NOVINE no. 84/14. *Odluka o dražbovatelju za obavljanje poslova dražbe emisijskih jedinica i izboru dražbenog sustava*. Zagreb: Narodne novine d.d.
328. NARODNE NOVINE no. 89/20. *Uredba o načinu trgovanja emisijskim jedinicama stakleničkih plinova*. Zagreb: Narodne novine d.d.
329. NATIONAL CENTER FOR BIOTECHNOLOGY INFORMATION [NCBI]. 2024. *PubChem Compound Summary for CID 700, Monoethanolamine*. <https://pubchem.ncbi.nlm.nih.gov/compound/Monoethanolamine>
330. NATIONAL ENERGY TECHNOLOGY LABORATORY [NETL]. n.d.-a. 5.1.2. *Reactions & Transformations*. <https://netl.doe.gov/research/coal/energy-systems/gasification/gasifipedia/reaction-transformations> (16.02.2023)
331. NATIONAL ENERGY TECHNOLOGY LABORATORY [NETL]. n.d.-b. 9.2. *Commercial Carbon Dioxide Uses: Carbon Dioxide Enhanced Oil Recovery*. <https://netl.doe.gov/research/coal/energy-systems/gasification/gasifipedia/eor> (16.01.2024)
332. NATIONAL HEALTH SERVICE. 2023. *Storing tissue safely*. <https://www.nhsbt.nhs.uk/tissue-and-eye-services/support/storing-tissue-safely/> (16.12.2023)
333. NATIONAL INSTITUTE OF STANDARDS AND TECHNOLOGY [NIST]. 2023. *Monoethanolamine*. <https://webbook.nist.gov/cgi/cbook.cgi?ID=C141435> (16.02.2024)
334. NATIONAL OCEANIC AND ATMOSPHERIC ADMINISTRATION [NOAA]. 2024. *Ethanolamine*. <https://cameochemicals.noaa.gov/chemical/1146> (16.02.2024)
335. NBTC.NACO.GOV.IN. n.d. *Storage and Transportation of Blood and its components*. <http://nbt.naco.gov.in/assets/resources/training/8.pdf> (16.02.2024)
336. NEVEUX, T., MOULLEC, Y. L., CORRIOU, J. P., FAVRE, E. 2013. *Energy*

- performance of CO<sub>2</sub> capture processes: Interaction between process design and solvent.* Chemical Engineering Transactions, 35, 337–342. <https://doi.org/10.3303/CET1335056>
337. NGUYEN, T. 2020. *Gas lift.* In *Artificial Lift Methods* (pp. 41–106), Part of the book series *Petroleum Engineering*. Cham: Springer International Publishing. [http://dx.doi.org/10.1007/978-3-030-40720-9\\_2](http://dx.doi.org/10.1007/978-3-030-40720-9_2)
338. NIEMZ, M. H. 2019. *Medical applications of lasers.* In *Laser-Tissue Interactions* (pp. 153–249). Cham: Springer International Publishing. [http://dx.doi.org/10.1007/978-3-030-11917-1\\_4](http://dx.doi.org/10.1007/978-3-030-11917-1_4)
339. NIPPON GASES. 2023. *Dry Ice for Pharma & Biotech Industry.* <https://nippongases.com/gb-en/gases/dry-ice-for-pharma-and-biotech> (16.12.2023)
340. NOOR AKASHAH, M. H., MOHAMMAD ROZALI, N. E., MAHADZIR, S., LIEW, P. Y. 2023. *Utilization of cold energy from LNG regasification process: A review of current trends.* Processes, 11(2), 517. <https://doi.org/10.3390/pr11020517>
341. NOORMAN, F., VAN DONGEN, T. T. C. F., PLAT, M.-C. J., BADLOE, J. F., HESS, J. R., HOENCAMP, R. 2016. *Transfusion: -80°C frozen blood products are safe and effective in military casualty care.* PloS One, 11(12), e0168401. <https://doi.org/10.1371/journal.pone.0168401>
342. NORDIC ELECTROFUEL. 2022. *What we do.* <https://nordicelectrofuel.no/what-we-do/>
343. NOVAK, K. 2015. *Modeliranje površinskoga transporta i geološki aspekti skladištenja ugljikova dioksida u neogenska pješčenjačka ležišta Sjeverne Hrvatske na primjeru polja Ivanić* [PhD Thesis, Faculty of Mining, Geology and Petroleum Engineering, University of Zagreb]. <https://repositorij.rgn.unizg.hr/islandora/object/rgn:644>
344. NWAOHA, C., IDEM, R., SUPAP, T., SAIWAN, C., TONTIWACHWUTHIKUL, P., RONGWONG, W., AL-MARRI, M. J., BENAMOR, A. 2017. *Heat duty, heat of absorption, sensible heat and heat of vaporization of 2-Amino-2-Methyl-1-Propanol (AMP), Piperazine (PZ) and Monoethanolamine (MEA) tri-solvent blend for carbon dioxide (CO<sub>2</sub>) capture.* Chemical Engineering Science, 170, 26–35. <https://doi.org/10.1016/j.ces.2017.03.025>



345. NWAHOHA, C., SAIWAN, C., SUPAP, T., IDEM, R., TONTIWACHWUTHIKUL, P., RONGWONG, W., AL-MARRI, M. J., BENAMOR, A. 2016. *Carbon dioxide (CO<sub>2</sub>) capture performance of aqueous tri-solvent blends containing 2-amino-2-methyl-1-propanol (AMP) and methyldiethanolamine (MDEA) promoted by diethylenetriamine (DETA)*. *International Journal of Greenhouse Gas Control*, 53, 292–304. <https://doi.org/10.1016/j.ijggc.2016.08.012>
346. NYSSSEN, T. 2022. *Modelisation and optimisation of a CO<sub>2</sub> capture process with a new benchmark solvent for the Sart-Tilman cogeneration plant* [Master thesis, University of Liège]. [https://matheo.uliege.be/bitstream/2268.2/14573/5/TFE\\_NYSSSEN\\_Thomas.pdf](https://matheo.uliege.be/bitstream/2268.2/14573/5/TFE_NYSSSEN_Thomas.pdf)
347. NJIRIĆ, M. 2022. *Optimiranje strukture energetskeg sustava za proizvodnju sintetskog plina korištenjem programa EnergyPLAN* [Master thesis, Faculty of Mining, Geology and Petroleum Engineering, University of Zagreb]. <https://urn.nsk.hr/urn:nbn:hr:169:717248>
348. OBEROI DRAŽIĆ, A. O. 2023. *Projekti kaptiranja i geološkog skladištenja CO<sub>2</sub> s aspekta procjene rizika migracije* [Master thesis, Faculty of Mining, Geology and Petroleum Engineering, University of Zagreb]. <https://urn.nsk.hr/urn:nbn:hr:169:137634>
349. OCHOA ROBLES, J., DE-LEÓN ALMARAZ, S., AZZARO-PANTEL, C. 2018. *Chapter 2 - Hydrogen supply chain design: Key technological components and sustainable assessment*. In *Hydrogen Supply Chains* (pp. 37–79). Amsterdam: Elsevier. <http://dx.doi.org/10.1016/b978-0-12-811197-0.00002-6>
350. OFFICIAL JOURNAL OF THE EUROPEAN UNION, L 275, 25 OCTOBER 2003. *Directive 2003/87/EC of the European Parliament and of the Council of 13 October 2003 establishing a system for greenhouse gas emission allowance trading within the Union and amending Council Directive 96/61/EC*. Luxembourg: Publications Office of the European Union
351. OFFICIAL JOURNAL OF THE EUROPEAN UNION, Series L 2012/083 22.3.2012. *COMMISSION REGULATION (EU) No 231/2012 of 9 March 2012 laying down specifications for food additives listed in Annexes II and III to Regulation (EC) No 1333/2008 of the European Parliament and of the Council*. Luxembourg: Publications

Office of the European Union

352. OFFICIAL JOURNAL OF THE EUROPEAN UNION, Series L 2023/2830 20.12.2023. *COMMISSION DELEGATED REGULATION (EU) 2023/2830 of 17 October 2023 supplementing Directive 2003/87/EC of the European Parliament and of the Council by laying down rules on the timing, administration and other aspects of auctioning of greenhouse gas emission allowances.* Luxembourg: Publications Office of the European Union

353. OFFICIALDATA.ORG. 2024. *Euro Inflation Calculator.* <https://www.officialdata.org/europe/inflation/2020> (14.08.2024)

354. OFFSHORE-ENERGY.BIZ. 2021. *Croatia's LNG terminal starts commercial operation.* <https://www.offshore-energy.biz/croatias-lng-terminal-starts-commercial-operation/> (05.09.2024)

355. ØI, L. E., NITSCHKE, P., AROMADA, S. 2022. Comparison of absorption and adsorption processes for CO<sub>2</sub> dehydration. *Linköping Electronic Conference Proceedings.* <http://dx.doi.org/10.3384/ecp21185287>

356. OLABI, A. G., ALAMI, A. H., AYOUB, M., ALJAGHOUB, H., ALASAD, S., INAYAT, A., ABDELKAREEM, M. A., CHAE, K.-J., SAYED, E. T. 2023. *Membrane-based carbon capture: Recent progress, challenges, and their role in achieving the sustainable development goals.* *Chemosphere*, 320, 137996. <https://doi.org/10.1016/j.chemosphere.2023.137996>

357. ORANGI, S. 2021. *Simulation and cost estimation of CO<sub>2</sub> capture processes using different solvents/blends* [Master thesis, University of South-Eastern Norway]. <https://openarchive.usn.no/usn-xmlui/handle/11250/2774682>

358. ORANGI, S. 2023. Electronic mail with Sina Orangi, 16<sup>th</sup> June 2023.

359. OSBORN, P. D. 2014. *Handbook of Energy Data and Calculations: Including Directory of Products and Services.* Amsterdam: Elsevier Science. <https://books.google.hr/books?id=aWs-AwAAQBAJ&dq>

360. OUELLETTE, R. J., RAWN, J. D. 2015. *15 - Synthetic polymers.* In *Principles of Organic Chemistry* (pp. 397–419). Amsterdam: Elsevier. <http://dx.doi.org/10.1016/b978-0->

[12-802444-7.00015-x](#)

361. OYENEKAN, B. A., ROCHELLE, G. T. 2007. *Alternative stripper configurations for CO<sub>2</sub> capture by aqueous amines*. *AIChE Journal*, 53(12), 3144–3154. <https://doi.org/10.1002/aic.11316>
362. PAHLJINA, L. 2023. *Integracija proizvodnje desalinizirane vode u postojeći kogeneracijski sustav* [Master thesis, Faculty of Engineering, University of Rijeka]. <https://urn.nsk.hr/urn:nbn:hr:190:899864>
363. PAL, M., GIRI, R., SHARMA, R. K. 2022. *Chapter 15 - Production of biofuels in a microbial electrochemical reactor*. In *Biofuels and Bioenergy* (pp. 303–319). Amsterdam: Elsevier. <http://dx.doi.org/10.1016/b978-0-323-85269-2.00010-1>
364. PANJA, P., MCPHERSON, B., DEO, M. 2022. *Techno-Economic analysis of amine-based CO<sub>2</sub> capture technology: Hunter plant case study*. *Carbon Capture Science & Technology*, 3, 100041. <https://doi.org/10.1016/j.ccst.2022.100041>
365. PAREKH, S. 2020. *Hybrid system – an emerging solution to sour gas treatment*. OnePetro. <https://onepetro.org/IPTCONF/proceedings-abstract/20IPTC/2-20IPTC/D022S143R001/154542>
366. PARMAR, N., SHAH, K. 2017. *Design and analysis shell and tube type heat exchanger; Taguchi method and CFD analysis*. Saarbrücken: Lambert Academic Publishing. [https://www.researchgate.net/publication/318815034\\_Design\\_and\\_analysis\\_shell\\_and\\_tube\\_type\\_heat\\_exchanger\\_Taguchi\\_method\\_and\\_CFD\\_analysis](https://www.researchgate.net/publication/318815034_Design_and_analysis_shell_and_tube_type_heat_exchanger_Taguchi_method_and_CFD_analysis)
367. PASHAEI, H., GHAEMI, A. 2022. *Review of CO<sub>2</sub> capture using absorption and adsorption technologies*. *Iranian Journal of Chemistry and Chemical Engineering*, 41(8), 2771–2789. <https://doi.org/10.30492/ijcce.2021.141772.4453>
368. PATEL, M. M. 2023. *TEMA standards and the shell & tube heat exchanger design*. <https://heat-exchanger-world.com/tema-standards-and-the-shell-and-tube-heat-exchanger-design/> (21.05.2023)
369. PATONIA, A., POUDINEH, R. 2023. *Hydrogen storage for a net-zero carbon future*. Oxford: Oxford Institute for Energy Studies.

- <https://www.oxfordenergy.org/publications/hydrogen-storage-for-a-net-zero-carbon-future/>
370. PAVLIĆ, M. 2021. *Analiza distribucije lijekova u Republici Hrvatskoj* [Master thesis, Faculty of Transport and Traffic Sciences, University of Zagreb]. <https://urn.nsk.hr/urn:nbn:hr:119:783291>
371. PAVLOVIĆ, M. 2021. *Thermodynamics, FUEL COMBUSTION - course material*. Požega: Tehnička škola Požega. Accessed at: [https://arhiva-2021.loomen.carnet.hr/pluginfile.php/5209643/mod\\_folder/content/0/IZGARANJE%20GORIVA..pdf](https://arhiva-2021.loomen.carnet.hr/pluginfile.php/5209643/mod_folder/content/0/IZGARANJE%20GORIVA..pdf) (21.05.2024)
372. PERKOVIĆ, L. 2021. *Podizanje kapljevine primjenom povremenog plinskog lifta* [Bachelor Thesis, Faculty of Mining, Geology and Petroleum Engineering, University of Zagreb]. <https://urn.nsk.hr/urn:nbn:hr:169:785261>
373. PESCARMONA, P. P. 2021. *Cyclic carbonates synthesised from CO<sub>2</sub>: Applications, challenges and recent research trends*. *Current Opinion in Green and Sustainable Chemistry*, 29, 100457. <https://doi.org/10.1016/j.cogsc.2021.100457>
374. PEU, S. D., DAS, A., HOSSAIN, MD. S., AKANDA, MD. A. M., AKANDA, MD. M. H., RAHMAN, M., MIAH, MD. N., DAS, B. K., ISLAM, A. R. MD. T., SALAH, M. M. 2023. *A comprehensive review on recent advancements in absorption-based post combustion carbon capture technologies to obtain a sustainable energy sector with clean environment*. *Sustainability*, 15(7). <https://doi.org/10.3390/su15075827>
375. PORSCHE. 2023. *E-fuels*. <https://newsroom.porsche.com/en/press-kits/Porsche-Heritage-Experience/eFuels.html> (11.01.2024)
376. PORSCHE. 2022. *eFuels pilot plant in Chile officially opened*. <https://newsroom.porsche.com/en/2022/company/porsche-highly-innovative-fuels-hif-opening-efuels-pilot-plant-haru-oni-chile-synthetic-fuels-30732.html> (11.01.2024)
377. POWER, N. E., SILBERSTEIN, J. L., GHONEIM, T. P., GUILLONNEAU, B., TOUIJER, K. A. 2012. *Environmental impact of minimally invasive surgery in the United States: An estimate of the carbon dioxide footprint*. *Journal of Endourology*, 26(12), 1639–1644. <https://doi.org/10.1089/end.2012.0298>
378. PROINSTAL ŠKAREC. 2024. *Zamjena boca CO<sub>2</sub>, Argon, Argon + Co<sub>2</sub>, Dušik*,

Kisik, Helij – punjenje. <https://proinstal.hr/shop/zamjena-boca/zamjena-boca-co2-argon-argon-co2-dusik-kisik-helij-punjenje/> (21.05.2024)

379. PROINSTAL ŠKAREC. 2023. Telephone call with Proinstal Škarec d.o.o., 20<sup>th</sup> July 2023.

380. PRUESS, K. 2007. *Enhanced Geothermal Systems (EGS) comparing water with CO<sub>2</sub> as heat transmission fluids*. Lawrence Berkeley National Laboratory. <https://escholarship.org/uc/item/1fr9q7q8>

381. PUBLIYON. 2024. *Carbon capture, utilisation and storage (CCUS): what is the EU's plan?* <https://publyon.com/carbon-capture-utilisation-and-storage-ccus-what-is-the-eus-plan/> (21.08.2024)

382. QUANG, D. V., MILANI, D., ABU ZAHRA, M. 2023. *A review of potential routes to zero and negative emission technologies via the integration of renewable energies with CO<sub>2</sub> capture processes*. International Journal of Greenhouse Gas Control, 124, 103862. <https://doi.org/10.1016/j.ijggc.2023.103862>

383. RAHO, B., COLANGELO, G., MILANESE, M., DE RISI, A. 2022. *A critical analysis of the oxy-combustion process: From mathematical models to combustion product analysis*. Energies, 15(18). <https://doi.org/10.3390/en15186514>

384. RAI, B. 2016. *CO<sub>2</sub> dehydration after CO<sub>2</sub> capture* [Master thesis, University of South-Eastern Norway]. <https://openarchive.usn.no/usn-xmlui/handle/11250/2479825>

385. RAMACHANDRAN, N., ABOUDHEIR, A., IDEM, R., TONTIWACHWUTHIKUL, P. 2006. *Kinetics of the absorption of CO<sub>2</sub> into mixed aqueous loaded solutions of monoethanolamine and methyldiethanolamine*. Industrial & Engineering Chemistry Research, 45(8), 2608–2616. <https://doi.org/10.1021/ie0505716>

386. RAO, A. D. 2010. *Gas-fired combined-cycle power plant design and technology*. In *Advanced Power Plant Materials, Design and Technology* (pp. 32–53). Amsterdam: Elsevier. <http://dx.doi.org/10.1533/9781845699468.1.32>

387. RAPIDTABLES.COM. 2024. *Pounds to kg conversion*. <https://www.rapidtables.com/convert/weight/pound-to-kg.html> (21.04.2024)

388. RAZZAGHIANARMARZI, A. 2024. *Process simulation and cost estimation of*

*CO2 capture configurations in Aspen HYSYS including Vapour Recompression* [Master thesis, University of South-Eastern Norway]. <https://openarchive.usn.no/usn-xmlui/handle/11250/3126335>

389. REĐEP, A. 2021. *Analiza troškova hvatanja, transporta i skladištenja ugljikovog dioksida i razvitak projekata u Norveškoj* [Master thesis, Faculty of Mining, Geology and Petroleum Engineering, University of Zagreb]. <https://repozitorij.rgn.unizg.hr/islandora/object/rgn:1843>

390. REGIONAL GREENHOUSE GAS INITIATIVE. n.d. *The Regional Greenhouse Gas Initiative of Eastern - an initiative of Eastern States of the US*. <https://www.rggi.org/> (21.05.2023)

391. REIMERT, R., MARSCHNER, F., RENNER, H., BOLL, W., SUPP, E., BREJC, M., LIEBNER, W., SCHAUB, G. 2011. *Gas production, 2. Processes*. In *Ullmann's Encyclopedia of Industrial Chemistry*. Weinheim: Wiley-VCH Verlag GmbH & Co. KGaA. [https://doi.org/10.1002/14356007.o12\\_o01](https://doi.org/10.1002/14356007.o12_o01)

392. RIDJAN, I., MATHIESEN, B. V., CONNOLLY, D. 2016. *Terminology used for renewable liquid and gaseous fuels based on the conversion of electricity: A review*. *Journal of Cleaner Production*, 112, 3709–3720. <https://doi.org/10.1016/j.jclepro.2015.05.117>

393. RIVIERAMM.COM. 2020. *Golar LNG FSRU converted for Croatia*. <https://www.rivieramm.com/news-content-hub/news-content-hub/golar-lng-fsru-converted-for-croatia-60996> (21.08.2024)

394. ROBERTSON, B., MOUSAVIAN, M. 2022. *The Carbon Capture Crux: Lessons Learned*. Lakewood: Institute for Energy Economics and Financial Analysis (IEEFA). <https://ieefa.org/resources/carbon-capture-crux-lessons-learned>

395. ROONEY, P., EAGLE, M. J., KEARNEY, J. N. 2015. *Validation of cold chain shipping environment for transport of allografts as part of a human tissue bank returns policy*. *Cell and Tissue Banking*, 16(4), 553–558. <https://doi.org/10.1007/s10561-015-9502-0>

396. RUFFORD, T. E., SMART, S., WATSON, G. C. Y., GRAHAM, B. F., BOXALL, J., DINIZ DA COSTA, J. C., MAY, E. F. 2012. The removal of CO<sub>2</sub> and N<sub>2</sub> from natural

- gas: A review of conventional and emerging process technologies. *Journal of Petroleum Science and Engineering*, 94–95, 123–154. <https://doi.org/10.1016/j.petrol.2012.06.016>
397. S&P GLOBAL. 2023. *No recovery in sight in 2024 for Europe's crisis-ridden chemical industry*. <https://www.spglobal.com/commodityinsights/en/market-insights/latest-news/chemicals/122923-no-recovery-in-sight-in-2024-for-europes-crisis-ridden-chemical-industry> (21.07.2023)
398. SALONA VAR. 2023. Telephone call with Salona Var, 28th July 2023.
399. SAMIPOUR, S., MANSHADI, M. D., SETOODEH, P. 2020. *Chapter 20 - CO<sub>2</sub> removal from biogas and syngas*. In *Advances in Carbon Capture* (pp. 455–477). Amsterdam: Elsevier. <http://dx.doi.org/10.1016/b978-0-12-819657-1.00020-7>
400. SARAVANAN, A., DEIVAYANAI, V. C., SENTHIL KUMAR, P., RANGASAMY, G., VARJANI, S. 2022. *CO<sub>2</sub> bio-mitigation using genetically modified algae and biofuel production towards a carbon net-zero society*. *Bioresource Technology*, 363, 127982. <https://doi.org/10.1016/j.biortech.2022.127982>
401. SASS, B., MONZYK, B., RICCI, S., GUPTA, A., HINDIN, B., GUPTA, N. 2005. *Chapter 17 - Impact of SO<sub>x</sub> and NO<sub>x</sub> in Flue Gas on CO<sub>2</sub> Separation, Compression, and Pipeline Transmission*. In *Carbon Dioxide Capture for Storage in Deep Geologic Formations* (pp. 955–981). Amsterdam: Elsevier. <http://dx.doi.org/10.1016/b978-008044570-0/50144-6>
402. SATURN.DE. 2024. *KOENIC KCO2F CO<sub>2</sub>-Zylinder nur bei Rückgabe eines Leerzylinders, nur Marktabholung CO<sub>2</sub>-Gas*. [https://www.saturn.de/de/product/\\_koenic-kco2f-co2-zylinder-fullung-2722384.html](https://www.saturn.de/de/product/_koenic-kco2f-co2-zylinder-fullung-2722384.html) (21.08.2024)
403. SCHASCHKE, C. 2014. *A Dictionary of Chemical Engineering*. Oxford University Press. <http://dx.doi.org/10.1093/acref/9780199651450.001.0001>
404. SCHMELZ, W. J., HOCHMAN, G., MILLER, K. G. 2020. *Total cost of carbon capture and storage implemented at a regional scale: Northeastern and midwestern United States*. *Interface Focus*, 10(5), 20190065. <https://doi.org/10.1098/rsfs.2019.0065>
405. SCHMIDT, L. D., HUFF, M., BHARADWAJ, S. S. 1994. *Catalytic partial oxidation reactions and reactors*. *Chemical Engineering Science*, 49(24), 3981–3994.

[https://doi.org/10.1016/s0009-2509\(05\)80002-8](https://doi.org/10.1016/s0009-2509(05)80002-8)

406. SEENEWS. 2014. *Croatia to join emissions auctions on common EU platform - EEX*. SeeNews. <https://seenews.com/news/croatia-to-join-emissions-auctions-on-common-eu-platform-eex-455272> (07.01.2024)

407. SEMELSBERGER, T. A. 2009. *FUELS – HYDROGEN STORAGE | Chemical Carriers*. In *Encyclopedia of Electrochemical Power Sources* (pp. 504–518). Amsterdam: Elsevier. <http://dx.doi.org/10.1016/b978-044452745-5.00331-2>

408. SEXTON, DR. ANDREW. J., FISHER, K., BEITLER, C., DOMBROWSKI, K., YOUNGERMAN, J., ROCHELLE, DR. G., CHEN, DR. E., NIELSEN, P., DAVISON, J., SINGH, DR. P. 2016. *Evaluation of Amine Reclaimer Operation and Waste Disposal from Post-Combustion CO<sub>2</sub> Capture*. Laurance Reid Gas Conditioning Conference 2016, Norman, Oklahoma, USA. <https://www.trimeric.com/assets/2016-eval-of-amine-reclaimer-cost-and-waste---from-proceedings.pdf>

409. SFC Energy. 2021. *Partial oxidation*. <https://web.archive.org/web/20230225022452/https://www.sfc.com/en/glossar/partial-oxidation/> (07.10.2023)

410. SHAO, R., STANGELAND, A. 2009. *Amines Used in CO<sub>2</sub> Capture – Health and Environmental Impacts*. Oslo: Bellona. <https://bellona.org/publication/amines-used-in-co2-capture-health-and-environmental-impacts>

411. SHI, F. 2014. *Reactor and process design in sustainable energy technology*. Amsterdam: Elsevier. <https://doi.org/10.1016/C2012-0-00576-5>

412. SIEMENS ENERGY. 2022. *Haru Oni: eFuel plant of the future*. <https://www.siemens-energy.com/global/en/home/stories/haru-oni.html> (07.11.2023)

413. SIEMIENIEC, M., KIERZKOWSKA-PAWLAK, H., CHACUK, A. 2012. *Reaction kinetics of carbon dioxide in aqueous diethanolamine solutions using the stopped-flow technique*. *Ecological Chemistry and Engineering S*, 19(1), 55–66. <https://doi.org/doi:10.2478/v10216-011-0006-y>

414. SIMON, K. 2020a. *Energy Consumption and Storage, course material*. Zagreb: Faculty of Mining, Geology and Petroleum Engineering, University of Zagreb



415. SIMON, K. 2020b. *Gathering and Transportation of Oil and Gas 2, course material*. Zagreb: Faculty of Mining, Geology and Petroleum Engineering, University of Zagreb
416. SINDHØJ, E., LINDAHL, C., BARK, L. 2021. *Review: Potential alternatives to high-concentration carbon dioxide stunning of pigs at slaughter*. *Animal*, 15(3), 100164. <https://doi.org/10.1016/j.animal.2020.100164>
417. SINGH, P. 2009. *Amine Based Solvent for CO<sub>2</sub> Absorption “From Molecular Structure to Process”* [PhD Thesis, University of Twente]. [https://ris.utwente.nl/ws/portalfiles/portal/6067104/thesis\\_P\\_Singh.pdf](https://ris.utwente.nl/ws/portalfiles/portal/6067104/thesis_P_Singh.pdf)
418. SINTEF. 2020. *The story of CO<sub>2</sub> as a refrigerant*. <https://www.sintef.no/en/latest-news/2020/co2-refrigerant/> (07.10.2022)
419. SMITH, R. 2005. *Chemical process: Design and integration*. Hoboken: John Wiley & Sons.
420. SODABAER.DE. 2024. *CO<sub>2</sub>-Tauschzylinder Kohlensäure FÜLLUNG 425g (60 l)*. <https://www.sodabaer.de/co2-zylinder/tauschen-wiederbefuellen/tauschzylinder-425g-60l> (22.08.2024)
421. SODAO-SHOP.DE. 2024. *10 kg kurz Kohlensäure-Tauschflasche-Füllung (41,65 € Preise inkl. MwSt. zzgl. Versandkosten)*. <https://sodao-shop.de/10-kg-kurz-Kohlensaure-Tauschflasche-Fuellung/OCO-Gastro-CO2-T-10kg-kurz> (22.08.2024)
422. SOLIZ, J., ENAB, K., LOPEZ, I., ELMASRY, Y. 2022. *Experimental investigation of gas injection performance with different fluid types*. *Proceedings of the 10th Unconventional Resources Technology Conference*. <http://dx.doi.org/10.15530/urtec-2022-3726038>
423. SOMARATHNA, H. M. C. C., RAMAN, S. N., MOHOTTI, D., MUTALIB, A. A., BADRI, K. H. 2018. *The use of polyurethane for structural and infrastructural engineering applications: A state-of-the-art review*. *Construction and Building Materials*, 190, 995–1014. <https://doi.org/10.1016/j.conbuildmat.2018.09.166>
424. SONGOLZADEH, M., SOLEIMANI, M., TAKHT RAVANCHI, M., SONGOLZADEH, R. 2014. *Carbon dioxide separation from flue gases: A technological review emphasizing reduction in greenhouse gas emissions*. *The Scientific World Journal*,

- 2014, 1–34. <https://doi.org/10.1155/2014/828131>
425. SOO, X. Y. D., LEE, J. J. C., WU, W.-Y., TAO, L., WANG, C., ZHU, Q., BU, J. 2024. *Advancements in CO<sub>2</sub> capture by absorption and adsorption: A comprehensive review*. Journal of CO<sub>2</sub> Utilization, 81, 102727. <https://doi.org/10.1016/j.jcou.2024.102727>
426. SPAN, R., WAGNER, W. 1996. *A new equation of state for carbon dioxide covering the fluid region from the triple-point temperature to 1100 K at pressures up to 800 MPa*. Journal of Physical and Chemical Reference Data, 25(6), 1509–1596. <https://doi.org/10.1063/1.555991>
427. SPEIGHT, J. G. 2011. *The Biofuels Handbook*. London: Royal Society of Chemistry. [https://www.google.hr/books/edition/The\\_Biofuels\\_Handbook/pqVspazTrmsC](https://www.google.hr/books/edition/The_Biofuels_Handbook/pqVspazTrmsC)
428. SPEIGHT, J. G. 2020. *Handbook of gasification technology*. Beverly: Scrivener Publishing LLC. <https://onlinelibrary.wiley.com/doi/book/10.1002/9781118773970>
429. STANDEN, A., KILLHEFFER, J. V. 2024. *Synthesis gas*. Encyclopedia Britannica. <https://www.britannica.com/technology/chemical-industry/Synthesis-gas> (15.03.2024)
430. STANGER, R., WALL, T., SPÖRL, R., PANERU, M., GRATHWOHL, S., WEIDMANN, M., SCHEFFKNECHT, G., MCDONALD, D., MYÖHÄNEN, K., RITVANEN, J., RAHALA, S., HYPPÄNEN, T., MLETZKO, J., KATHER, A., SANTOS, S. 2015. *Oxyfuel combustion for CO<sub>2</sub> capture in power plants*. International Journal of Greenhouse Gas Control, 40, 55–125. <https://doi.org/10.1016/j.ijggc.2015.06.010>
431. STEEN, D. P., ASHURST, P. R. 2006. *Carbonated Soft Drinks: Formulation and Manufacture*. Hoboken: Blackwell Publishing. <https://onlinelibrary.wiley.com/doi/book/10.1002/9780470996034>
432. STOCKMAN, DR. P. 2016. *Specialty Gas Report - Carbon Dioxide in Semiconductor Manufacturing - High-tech Uses for an Industrial Molecule*. Pullach: Linde. [https://web.archive.org/web/20221006130832/https://www.linde-gas.com/en/images/Carbon%20Dioxide%20in%20Semiconductor%20Manufacturing%20Specialty%20Gas%20Report%20May%202016\\_tcm17-419010.pdf](https://web.archive.org/web/20221006130832/https://www.linde-gas.com/en/images/Carbon%20Dioxide%20in%20Semiconductor%20Manufacturing%20Specialty%20Gas%20Report%20May%202016_tcm17-419010.pdf)
433. SUMON, K. Z., BAINS, C. H., MARKEWICH, D. J., HENNI, A., EAST, A. L. L. 2015. *Semicontinuum solvation modeling improves predictions of carbamate stability in the*

- CO<sub>2</sub> + aqueous amine reaction*. *The Journal of Physical Chemistry B*, 119(37), 12256–12264. <https://doi.org/10.1021/acs.jpcc.5b06076>
434. SUN, W., SHAO, Y., ZHAO, L., WANG, Q. 2020. *Co-removal of CO<sub>2</sub> and particulate matter from industrial flue gas by connecting an ammonia scrubber and a granular bed filter*. *Journal of Cleaner Production*, 257, 120511. <https://doi.org/10.1016/j.jclepro.2020.120511>
435. SUPEKAR, S. D., SKERLOS, S. J. 2014. *Supercritical carbon dioxide in microelectronics manufacturing: Marginal cradle-to-grave emissions*. *Procedia CIRP*, 15, 461–466. <https://doi.org/10.1016/j.procir.2014.06.061>
436. ŠIMUNEC, Đ. 2012. *Fizička otapala za izdvajanje kiselih plinova* [Master thesis, Faculty of Mining, Geology and Petroleum Engineering, University of Zagreb]. <https://repozitorij.rgn.unizg.hr/islandora/object/rgn%3A363>
437. TAKAHASHI, D., HASUDA, Y. 2021. *Development of an automatic sampling machine for mosquito surveillance*. *ICTE 2021 Conference Proceedings*. [https://www.researchgate.net/publication/377302682\\_ICTE\\_2021\\_Conference\\_Proceedings\\_Less\\_is\\_More\\_Issues\\_of\\_STEMSTEAM\\_Maker\\_and\\_Emerging\\_Technology\\_in\\_Technology\\_Education](https://www.researchgate.net/publication/377302682_ICTE_2021_Conference_Proceedings_Less_is_More_Issues_of_STEMSTEAM_Maker_and_Emerging_Technology_in_Technology_Education)
438. TALEI, S., FOZER, D., VARBANOV, P. S., SZANYI, A., MIZSEY, P. 2024. *Oxyfuel combustion makes carbon capture more efficient*. *ACS Omega*. <https://doi.org/10.1021/acsomega.3c05034>
439. TAYLOR, M. J., WEEGMAN, B. P., BAICU, S. C., GIWA, S. E. 2019. *New approaches to cryopreservation of cells, tissues, and organs*. *Transfusion Medicine and Hemotherapy*, 46(3), 197–215. <https://doi.org/10.1159/000499453>
440. TEHNIČKI LEKSIKON. 2007. <https://tehnicki.lzmk.hr/clanak/apsorbent> (15.04.2024)
441. THE GLOBE AND MAIL. 2021. *Alberta wants Ottawa to invest billions in carbon capture. That might not be a bad idea*. *The Globe and Mail*. <https://www.theglobeandmail.com/opinion/editorials/article-alberta-wants-ottawa-to-invest-billions-in-carbon-capture-that-might/> (15.01.2024)

442. THEODORE, L., RICCI, F. 2010. *Mass Transfer Operations for the Practicing Engineer*. Hoboken: John Wiley & Sons, Inc. <https://onlinelibrary.wiley.com/doi/book/10.1002/9780470602591>
443. THOMAS, S. 2007. *Enhanced Oil Recovery – An Overview*. Oil & Gas Science and Technology - Revue de l'IFP, 63(1), 9–19. <https://doi.org/10.2516/ogst:2007060>
444. TOMAR, S., AGARWAL, S., SINGH, H., KUMAR, R., QURESHI, K. A., JAREMKO, M., EMWAS, A.-H., RAI, P. K. 2023. *Microalgae: A promising source for biofuel production*. Biocatalysis and Agricultural Biotechnology, 53, 102877. <https://doi.org/10.1016/j.bcab.2023.102877>
445. TOMAŠIĆ, V. n.d.-a. *Elektrofiltri (Elektrostatski precipitatori, ESP)*. [https://www.fkit.unizg.hr/download/repository/Predavanje\\_4-2.pdf](https://www.fkit.unizg.hr/download/repository/Predavanje_4-2.pdf) (15.01.2023)
446. TOMAŠIĆ, V. n.d.-b. *Uklanjanje čvrstih onečišćujućih tvari/suspendiranih čestica suhim postupcima - otprašivanje*. [https://www.fkit.unizg.hr/download/repository/Predavanje\\_4-1.pdf](https://www.fkit.unizg.hr/download/repository/Predavanje_4-1.pdf) (15.01.2023)
447. TOPHAM, S., BAZZANELLA, A., SCHIEBAHN, S., LUHR, S., ZHAO, L., OTTO, A., STOLTEN, D. 2014. *Carbon dioxide*. In *Ullmann's Encyclopedia of Industrial Chemistry* (pp. 1–43). Weinheim: Wiley-VCH Verlag GmbH & Co. KGaA. [http://dx.doi.org/10.1002/14356007.a05\\_165.pub2](http://dx.doi.org/10.1002/14356007.a05_165.pub2)
448. TORRALBA-CALLEJA, E., SKINNER, J., GUTIÉRREZ-TAUSTE, D. 2013. *CO<sub>2</sub> capture in ionic liquids: A review of solubilities and experimental methods*. Journal of Chemistry, 2013(1). <https://doi.org/10.1155/2013/473584>
449. TRADINGECONOMICS.COM. 2024. *EU Carbon Permits*. <https://tradingeconomics.com/commodity/carbon> (15.08.2024)
450. TURK, J. 2023. *CO<sub>2</sub>-EOR u raspucanoj stijeni kao moguća CO<sub>2</sub>-negativna CCUS opcija* [Master thesis, Faculty of Mining, Geology and Petroleum Engineering, University of Zagreb]. <https://urn.nsk.hr/urn:nbn:hr:169:012045>
451. TURNER, J. H., LAWLESS, P. A., YAMAMOTO, T., COY, D. W. 1999. *Section 6: Particulate Matter Controls - Chapter 3: Electrostatic Precipitators*. In *EPA Air Pollution Control Cost Manual, Sixth Edition EPA/452/B-02-001*. Washington: EPA.

<https://www.epa.gov/sites/default/files/2020-11/documents/cs6ch3.pdf>

452. U.S. DEPARTMENT OF ENERGY [DOE]. n.d.-a. *Energy Efficiency and Renewable Energy - Alternative Fuels Data Center - Hydrogen basics*. <https://afdc.energy.gov/fuels/hydrogen-basics> (15.01.2024)

453. U.S. DEPARTMENT OF ENERGY [DOE]. n.d.-b. *Pre-Combustion carbon capture research - Office of Fossil Energy and Carbon Management*. Energy.Gov. <https://www.energy.gov/fecm/pre-combustion-carbon-capture-research> (15.03.2023)

454. U.S. ENERGY INFORMATION ADMINISTRATION. 2022. *U.S. ammonia prices rise in response to higher international natural gas prices*. <https://www.eia.gov/todayinenergy/detail.php?id=52358> (25.08.2024)

455. UNITCONVERTERS.NET. 2024. *Convert gallons to liters*. <https://www.unitconverters.net/volume/gallons-to-liters.htm> (25.07.2024)

456. UNITED STATES ENVIRONMENTAL PROTECTION AGENCY [EPA]. 2016. *Particulate Matter (PM) Basics*. <https://www.epa.gov/pm-pollution/particulate-matter-pm-basics> (15.11.2023)

457. UNIVERSAL INDUSTRIAL GASES. n.d. *Carbon Dioxide (CO<sub>2</sub>) Properties, Uses, Applications CO<sub>2</sub> Gas and Liquid Carbon Dioxide*. <https://web.archive.org/web/20230204153259/https://www.uigi.com/carbondioxide.html> (15.02.2024)

458. UNIVERSITY OF MICHIGAN. 2024. *Absorbers – Visual Encyclopedia of Chemical Engineering Equipment*. <https://encyclopedia.che.engin.umich.edu/absorbers/> (09.07.2024)

459. UPSTREAMONLINE.COM. 2022. *Mitsubishi to build liquefied CO<sub>2</sub> carrier for CCUS, while it also flags ammonia FSRU concept*. <https://www.upstreamonline.com/energy-transition/mitsubishi-to-build-liquefied-co2-carrier-for-ccus-while-it-also-flags-ammonia-fsru-concept/2-1-1162250> (09.07.2023)

460. USINFLATIONCALCULATOR.COM. 2024. *US Inflation calculator*. <http://usinflationcalculator.com> (09.08.2024)

461. VALERI, C. R., RAGNO, G. 2006. *Cryopreservation of human blood products*.

- Transfusion and Apheresis Science : Official Journal of the World Apheresis Association : Official Journal of the European Society for Haemapheresis, 34(3), 271–287.  
<https://doi.org/10.1016/j.transci.2005.11.010>
462. VAN WAGENER, D. H., GUPTA, A., ROCHELLE, G. T., BRYANT, S. L. 2013. *Amine solvent regeneration for co2capture using geothermal energy with advanced stripper configurations*. Oil & Gas Science and Technology – Revue d’IFP Energies Nouvelles, 69(6), 1105–1119. <https://doi.org/10.2516/ogst/2012099>
463. VATAVUK, W. M. 2002. *Updating the CE Plant Cost Index*. Chemical Engineering. [https://www.chemengonline.com/Assets/File/CEPCI\\_1\\_01-2002.pdf](https://www.chemengonline.com/Assets/File/CEPCI_1_01-2002.pdf)
464. VESELKO, D. 2016. *Uloga medicinske sestre u primjeni krvnih pripravaka i praćenje stanja pacijenta nakon primjene krvnih pripravaka* [Bachelor Thesis, University North]. <https://repositorij.unin.hr/islandora/object/unin:884>
465. VESSELFINDER.COM. 2024. LNG CROATIA. <https://www.vesselfinder.com/vessels/details/9256767> (29.08.2024)
466. VIDOVIĆ, M. 2018. *Projekt rashladnog postrojenja zatvorenog klizališta* [Master thesis, Faculty of Mechanical Engineering and Naval Architecture, University of Zagreb]. <https://urn.nsk.hr/urn:nbn:hr:235:313599>
- VIKARA, D., WENDT, A., MARQUIS, M., GRANT, T., RASSIPOUR, R., EPPINK, J., HEIDRICK, T. L., ALVARADO, R., GUINAN, A., SHIH, C. Y., LIN, S. 2019. *CO2 leakage during EOR operations – analog studies to geologic storage of CO2*. <https://www.osti.gov/biblio/1557141>
468. VUKOVIĆ, T. 2019. *New simplistic approach for MEOR modelling and uncertainty assesment* [Master thesis, Faculty of Mining, Geology and Petroleum Engineering, University of Zagreb]. <https://repositorij.rgn.unizg.hr/islandora/object/rgn:908>
469. VULIN, D., MOČILAC, I. K., JUKIĆ, L., ARNAUT, M., VODOPIĆ, F., SAFTIĆ, B., SEDLAR, D. K., CVETKOVIĆ, M. 2023. *Development of CCUS clusters in Croatia*. International Journal of Greenhouse Gas Control, 124, 103857. <https://doi.org/10.1016/j.ijggc.2023.103857>
470. VULIN, D., MUHASILOVIĆ, L., ARNAUT, M. 2020. *Possibilities for CCUS in*

- medium temperature geothermal reservoir.* Energy, 200, 117549.  
<https://doi.org/10.1016/j.energy.2020.117549>
471. WAGGONER, P. E. 1994. *How much can 10 billion people spare for nature?*. Report. [https://cast-science.org/wp-content/uploads/1994/02/CAST\\_R121\\_Ten-Billion-People\\_Nature.pdf](https://cast-science.org/wp-content/uploads/1994/02/CAST_R121_Ten-Billion-People_Nature.pdf) Ames: Council for Agricultural Science and Technology (CAST).
472. WANG, B., LI, H., XING, H., LI, X. 2022. *Modelling of gas-driven fracturing and fragmentation in liquid CO<sub>2</sub> blasting using finite-discrete element method.* Engineering Analysis with Boundary Elements, 144, 409–421.  
<https://doi.org/10.1016/j.enganabound.2022.08.041>
473. WANG, F., DENG, S., ZHAO, J., ZHAO, J., YANG, G., YAN, J. 2017. *Integrating geothermal into coal-fired power plant with carbon capture: A comparative study with solar energy.* Energy Conversion and Management, 148, 569–582.  
<https://doi.org/10.1016/j.enconman.2017.06.016>
474. WANG, M., LAWAL, A., STEPHENSON, P., SIDDEERS, J., RAMSHAW, C. 2011. *Post-combustion CO<sub>2</sub> capture with chemical absorption: A state-of-the-art review.* Chemical Engineering Research and Design, 89(9), 1609–1624.  
<https://doi.org/10.1016/j.cherd.2010.11.005>
475. WANG, Z. 2018. *1.23 Energy and air pollution.* In *Comprehensive Energy Systems* (pp. 909–949). Amsterdam: Elsevier. <http://dx.doi.org/10.1016/b978-0-12-809597-3.00127-9>
476. WÄRTSILÄ. 2024a. *Wärtsilä 34DF, Marine 3D Models & Drawings.*  
<https://www.wartsila.com/marine/products/engines-and-generating-sets/dual-fuel-engines/wartsila-34df/dimensions-w34df> (29.05.2024)
477. WÄRTSILÄ. 2024b. *Wärtsilä Exhaust Treatment.*  
<https://www.wartsila.com/marine/products/exhaust-treatment/carbon-capture-and-storage> (30.08.2024)
478. WÄRTSILÄ. 2022. *Wärtsilä 34DF PRODUCT GUIDE.* Report. Helsinki: Wärtsilä Finland Oy, Issue 1/2022.
479. WEIBEL, G. L., OBER, C. K. 2003. *An overview of supercritical CO<sub>2</sub> applications*

- in microelectronics processing*. *Microelectronic Engineering*, 65(1–2), 145–152. [https://doi.org/10.1016/s0167-9317\(02\)00747-5](https://doi.org/10.1016/s0167-9317(02)00747-5)
480. WEINBERG, A., SONG, L.-Y., WILKENING, C., SEVIN, A., BLAIS, B., LOUZAO, R., STEIN, D., DEFECHEREUX, P., DURAND, D., RIEDEL, E., RAFTERY, N., JESSER, R., BROWN, B., KELLER, M. F., DICKOVER, R., MCFARLAND, E., FENTON, T., PEDIATRIC ACTG CRYOPRESERVATION WORKING GROUP. 2009. *Optimization and limitations of use of cryopreserved peripheral blood mononuclear cells for functional and phenotypic T-cell characterization*. *Clinical and Vaccine Immunology : CVI*, 16(8), 1176–1186. <https://doi.org/10.1128/CVI.00342-08>
481. WHITE, C. W., III. 2002. *ASPEN Plus Simulation of CO2 Recovery Process*. <https://www.osti.gov/biblio/810497>
482. WHITTY, K. J. 2008. *Emissions from Syngas Combustion*. *Combustion Science and Technology*, 180(6), 1117–1136.
483. WIKBORG REIN. 2023. *Emission allowances trading*. <https://www.wr.no/aktuelt/emission-allowances-trading> (09.01.2024)
484. WU, Y., DAI, Y., XIE, W., CHEN, H., ZHU, Y. 2022. *Performance analysis for post-combustion CO2 capture in coal-fired power plants by integration with solar energy*. *Energy*, 261, 125239. <https://doi.org/10.1016/j.energy.2022.125239>
485. WU, Z., LIANG, X., LIANG, D., HUANG, Z. 2023. *CO2 capture from biomass gasification current technologies, challenges and future prospects*. *Academic Journal of Science and Technology*, 7(1), 206–212. <https://doi.org/10.54097/ajst.v7i1.11370>
486. XE.COM. 2024. *1 USD to EUR - Convert US Dollars to Euros*. <https://www.xe.com/currencyconverter/convert/?Amount=1&From=USD&To=EUR> (29.08.2024)
487. XU, G., LI, L., YANG, Y., TIAN, L., LIU, T., ZHANG, K. 2012. *A novel CO2 cryogenic liquefaction and separation system*. *Energy*, 42(1), 522–529. <https://doi.org/10.1016/j.energy.2012.02.048>
488. XU, G., LIANG, F., YANG, Y., HU, Y., ZHANG, K., LIU, W. 2014. *An improved CO2 separation and purification system based on cryogenic separation and distillation*



- theory*. *Energies*, 7(5), 3484–3502. <https://doi.org/10.3390/en7053484>
489. YALE E360. 2023. *Algae-Based Biofuel May Have Bigger Carbon Footprint Than Diesel, Analysis Shows*. <https://e360.yale.edu/digest/algae-biofuel-carbon-footprint> (09.07.2023)
490. YAMADA, H. 2020. *Amine-based capture of CO<sub>2</sub> for utilization and storage*. *Polymer Journal*, 53(1), 93–102. <https://doi.org/10.1038/s41428-020-00400-y>
491. YONGBO, F., WENJIE, D., SHIHAI, L., JIYAN, Q. 2018. *Experiment on micron-sized particle production of iron ore by rapid unloading of liquid CO<sub>2</sub>*. *Powder Technology*, 327, 449–455. <https://doi.org/10.1016/j.powtec.2017.12.039>
492. YU, C.-H., HUANG, C.-H., TAN, C.-S. 2012. *A review of CO<sub>2</sub> capture by absorption and adsorption*. *Aerosol and Air Quality Research*, 12(5), 745–769. <https://doi.org/10.4209/aaqr.2012.05.0132>
493. YUAN, S., CHANG, C., YAN, S., ZHOU, P., QIAN, X., YUAN, M., LIU, K. 2021. *A review of fire-extinguishing agent on suppressing lithium-ion batteries fire*. *Journal of Energy Chemistry*, 62, 262–280. <https://doi.org/10.1016/j.jechem.2021.03.031>
494. ZABOT, G. L. 2020. *Decaffeination using supercritical carbon dioxide*. In *Green Sustainable Process for Chemical and Environmental Engineering and Science* (pp. 255–278). Amsterdam: Elsevier. <http://dx.doi.org/10.1016/b978-0-12-817388-6.00011-8>
495. ZHANG, Y., DENG, H., KE, B., GAO, F. 2022. *Research on the explosion effects and fracturing mechanism of liquid carbon dioxide blasting*. *Mining, Metallurgy & Exploration*, 39(2), 521–530. <https://doi.org/10.1007/s42461-021-00514-8>
496. ZHANG, Z., PAN, S.-Y., LI, H., CAI, J., OLABI, A. G., ANTHONY, E. J., MANOVIC, V. 2020. *Recent advances in carbon dioxide utilization*. *Renewable and Sustainable Energy Reviews*, 125, 109799. <https://doi.org/10.1016/j.rser.2020.109799>
497. ZHU, Q. 2019. *Developments on CO<sub>2</sub>-utilization technologies*. *Clean Energy*, 3(2), 85–100. <https://doi.org/10.1093/ce/zkz008>
498. ZHU, Y., FREY, H. C. 2010. *Integrated gasification combined cycle (IGCC) power plant design and technology*. In *Advanced Power Plant Materials, Design and Technology* (pp. 54–88). Amsterdam: Elsevier. <http://dx.doi.org/10.1533/9781845699468.1.54>

499. ZHU, ZHEN, SIPPOLA, P., YLIVAARA, O. M. E., MODANESE, C., DI SABATINO, M., MIZOHATA, K., MERDES, S., LIPSANEN, H., SAVIN, H. 2019. *Low-Temperature Plasma-Enhanced Atomic Layer Deposition of SiO<sub>2</sub> Using Carbon Dioxide*. *Nanoscale Research Letters*, 14(1), 55. <https://doi.org/10.1186/s11671-019-2889-y>
500. ZHU, ZIHAN, XU, B. 2022. *Purification technologies for nox removal from flue gas: A review*. *Separations*, 9(10), 307. <https://doi.org/10.3390/separations9100307>
501. ZIELIŃSKI, M., DEBOWSKI, M., KAZIMIEROWICZ, J., ŚWICA, I. 2023. *Microalgal carbon dioxide (CO<sub>2</sub>) capture and utilization from the European Union perspective*. *Energies*, 16(3). <https://doi.org/10.3390/en16031446>
502. ŽILIĆ, I. 2017. *Inertisation* [Master thesis, Faculty of Mining, Geology and Petroleum Engineering, University of Zagreb]. <https://urn.nsk.hr/urn:nbn:hr:169:291794>
503. ŽIŽAK, M. 2019. *Nadoknada krvnih pripravaka u perioperacijskom razdoblju* [Master thesis, School of Medicine, University of Zagreb]. <https://urn.nsk.hr/urn:nbn:hr:105:432722>

## **STATUTORY DECLARATION**

*I declare that I wrote this Thesis and performed the associated research myself, using the knowledge gained at the Faculty of Mining, Geology and Petroleum Engineering and the literature cited in this work.*



---

Marko Kolovrat

## **IZJAVA**

*Izjavljujem da sam ovaj rad izradio samostalno na temelju znanja stečenih na Rudarsko-geološko-naftnom fakultetu služeći se navedenom literaturom.*



---

Marko Kolovrat



KLASA: 602-01/24-01/158  
URBROJ: 251-70-12-24-2  
U Zagrebu, 24. 9. 2024.

**Marko Kolovrat, student**

## RJEŠENJE O ODOBRENJU TEME

Na temelju vašeg zahtjeva primljenog pod KLASOM 602-01/24-01/158, URBROJ: 251-70-12-24-1 od 10.09.2024. priopćujemo vam temu diplomskog rada koja glasi:

### FEASIBILITY STUDY OF A CARBON CAPTURE AND UTILIZATION (CCU) PROJECT ON THE EXAMPLE OF THE CROATIAN LNG TERMINAL

Za mentoricu ovog diplomskog rada imenuje se u smislu Pravilnika o izradi i obrani diplomskog rada Prof. dr. sc. Daria Karasalihović Sedlar nastavnik Rudarsko-geološko-naftnog-fakulteta Sveučilišta u Zagrebu.

Mentorica:



(potpis)

Prof. dr. sc. Daria Karasalihović  
Sedlar

(titula, ime i prezime)

Predsjednica povjerenstva za  
završne i diplomske ispite:



(potpis)

Izv. prof. dr. sc. Karolina  
Novak Mavar

(titula, ime i prezime)

Proděkan za nastavu i studente:

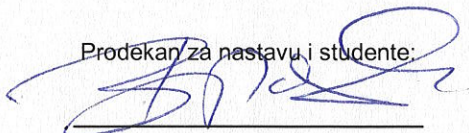

(potpis)

Izv. prof. dr. sc. Borivoje  
Pašić

(titula, ime i prezime)